

# Ecophon Super G™ A

Ecophon Super G™ A has an exposed grid system with impact bracing bars or clips to keep tiles in place. For applications in school corridors and other environments where there is a risk for mechanical impact.

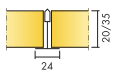

## SYSTEM RANGE



Size, mm	600x600	600x600	1200x600	1200x600	XL 1600x600	XL 1800x600	XL 2000x600	XL 2400x600
T24	•	•	•	•	•	•	•	•
Thickness (THK)	20	35	20	35	35	35	35	35
Inst. Diagr.	M199	M55	M199	M55	M55	M55	M55	M55

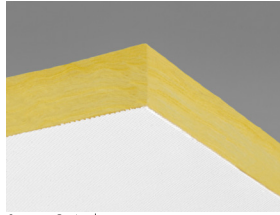

Super G A tile

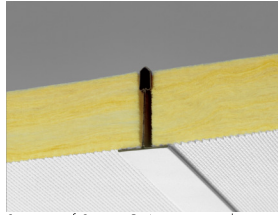

Section of Super G A system with Connect T24



Super G A system

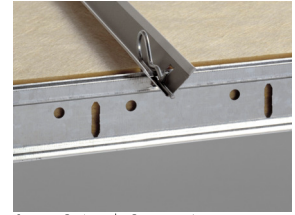

Super G A with Connect Impact bracing

## Acoustic



### Sound Absorption:

Test results according to EN ISO 354. Classification according to EN ISO 11654, and the single value ratings for Noise Reduction Coefficient, NRC and Sound Absorption Average, SAA according to ASTM C 423.

$\alpha_p$ , Practical sound absorption coefficient

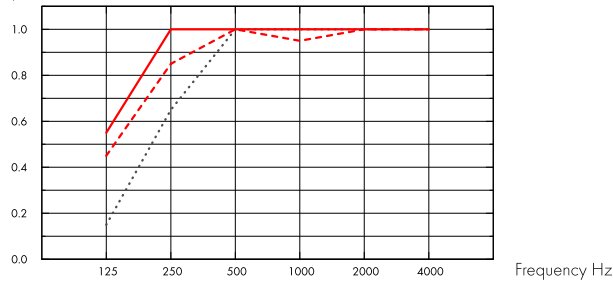

- Super G A 20 mm, 200 mm o.d.s.
  - .... Super G A 35 mm, 50 mm o.d.s.
  - Super G A 35 mm, 200 mm o.d.s.
- o.d.s = overall depth of system

THK mm	o.d.s. mm	$\alpha_p$ , Practical sound absorption coefficient						$\alpha_w$	Sound absorption class
		125 Hz	250 Hz	500 Hz	1000 Hz	2000 Hz	4000 Hz		
20	200	0.45	0.85	1.00	0.95	1.00	1.00	1.00	A
35	50	0.15	0.65	1.00	1.00	1.00	1.00	0.95	B
35	200	0.55	1.00	1.00	1.00	1.00	1.00	1.00	A

THK mm	o.d.s. mm	NRC	SAA
35	50	0.95	
35	200	1.05	
35	400	0.90	0.92

## Indoor Air Quality



Certificate / Label

Eurofins Indoor Air Comfort®

IAC Gold

French VOC

A+



## Carbon footprint



	kg CO <sub>2</sub> equiv/m <sup>2</sup>
Super G A 20mm	3,28
Super G A 35mm	4,90

Life-cycle stages A1 to C4 from EPD, in conformity with ISO 14025 / EN 15804



## Circularity

Minimum post-consumer recycled content (35 mm Super GA)	51%
Minimum post-consumer recycled content (20 mm Super GA)	42%
Recyclability	Fully recyclable



## Fire safety

Country	Class	
Europe	EN 13501-1	A2-s1,d0

The glass wool core of the tiles is tested and classified as non-combustible according to EN ISO 1182.



## Humidity Resistance

Class C, relative humidity 95% and 30°C, according to EN 13964:2014



## Visual appearance

White 085. Nearest NCS colour sample: S 1002-Y. Light reflectance: 78%. (The tiles need to be installed in accordance with the arrows on the back of the tile in order to get optimal visual appearance).



## Cleanability

Daily dusting and vacuum cleaning. Weekly wet wiping.



## Accessibility

The tiles are not demountable.



## Installation

Installed according to installation diagrams, installation guides and drawing aid. (The tiles have to be installed according to the arrows on the back of the tile.)



## System weight

	kg/m <sup>2</sup>
Super G A 20 mm	1,7
Super G A 20 mm + Connect Grid System	2,7
Super G A 35 mm	2,6
Super G A 35 mm + Connect Grid System	3,6

Weight information is indicative and subject to variation.



## Mechanical properties

See table regarding the min- and max- load bearing capacities and functional demands.



## Impact Resistance

Thickness	M-sketch	Classification
20	M199	3A
35	M55	2A

Tested and classified according to EN 13964 annex D.



## CE

Ecophon ceiling systems are CE marked according to the European harmonized standard EN 13964:2014. CE marked construction products are covered by a Declaration of Performance (DOP) which enables customers and users to easily compare performance of products available on the European market.

## INSTALLATION DIAGRAM (M199) FOR ECOPHON SUPER G A (20MM)

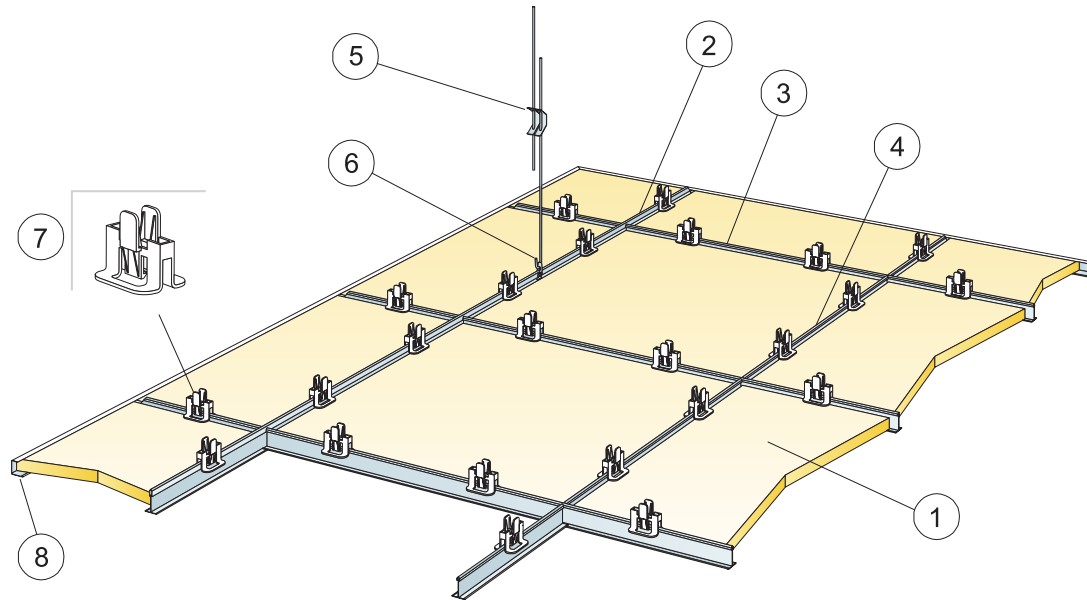

© Ecophon Group

### QUANTITY SPECIFICATION (EXCL. WASTAGE)

	Size, mm	
	600x600	1200x600
1 Super G A	2,8/m <sup>2</sup>	1,4/m <sup>2</sup>
2 Connect T24 Main runner, installed at 1200 mm centres (max distance from wall 300 mm)	0,9m/m <sup>2</sup>	0,9m/m <sup>2</sup>
3 Connect T24 Cross tee, L=1200 mm, installed at 600 mm centres	1,7m/m <sup>2</sup>	1,7m/m <sup>2</sup>
4 Connect T24 Cross tee, L=600 mm	0,9m/m <sup>2</sup>	-
5 Connect Adjustable hanger, installed at 1200 mm centres (max. distance from wall 600 mm)	0,7/m <sup>2</sup>	0,7/m <sup>2</sup>
6 Connect Hanger clip (secured with screw)	0,7/m <sup>2</sup>	0,7/m <sup>2</sup>
7 Connect Hygiene Clip 20	11/m <sup>2</sup>	7/m <sup>2</sup>
8 Connect Channel trim	as required	as required
Δ Min. overall depth of system: 150 mm	-	-
δ Min. demounting depth: 150 mm (non-clipped panel)	-	-

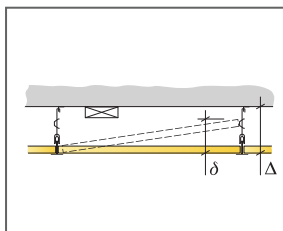

See Quantity Specification

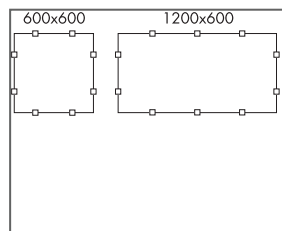

Arrangement of clips

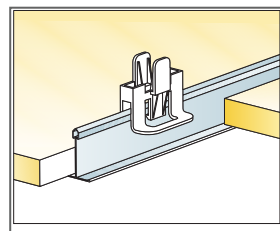

Clip for keeping tiles in place

Size, mm	Max live load [N]	Min load bearing capacity [N]
600x600x20	50	160
1200x600x20	50	160

Live load/load bearing capacity

INSTALLATION DIAGRAM (M55) FOR ECOPHON SUPER G A AND SUPER G A XL, SUSPENDED INSTALLATION (35MM)

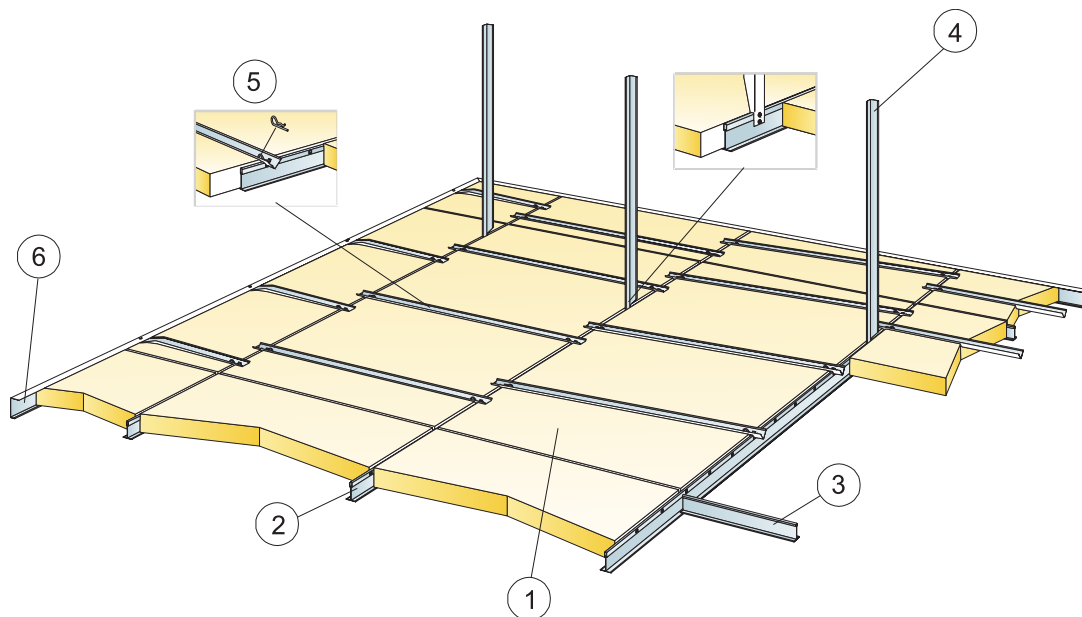

© Ecophon Group

QUANTITY SPECIFICATION (EXCL. WASTAGE)

	Size, mm					
	600x600	1200x600	1600x600	1800x600	2000x600	2400x600
1 Super G A and Super G A XL	2,8/m <sup>2</sup>	1,4/m <sup>2</sup>	1,05/m <sup>2</sup>	0,95/m <sup>2</sup>	0,85/m <sup>2</sup>	0,7/m <sup>2</sup>
2 Connect T24 Main runner, installed at 600 mm centres	1,7m/m <sup>2</sup>	1,7m/m <sup>2</sup>	1,7m/m <sup>2</sup>	1,7m/m <sup>2</sup>	1,7m/m <sup>2</sup>	1,7m/m <sup>2</sup>
3 Connect T24 Cross tee, L=600 mm	1,7m/m <sup>2</sup>	0,9m/m <sup>2</sup>	0,65m/m <sup>2</sup>	0,6m/m <sup>2</sup>	0,5m/m <sup>2</sup>	0,45m/m <sup>2</sup>
4 Rigid hanger made of Connect Angle trim, max. L=1200 mm at 1200 mm centres	1,4/m <sup>2</sup>	1,4/m <sup>2</sup>	1,4/m <sup>2</sup>	1,4/m <sup>2</sup>	1,4/m <sup>2</sup>	1,4/m <sup>2</sup>
5 Connect Impact Bracing (Split pins included)	5,6/m <sup>2</sup>	4,2/m <sup>2</sup>	4,2/m <sup>2</sup>	4,2/m <sup>2</sup>	4,2/m <sup>2</sup>	4,2/m <sup>2</sup>
6 Connect Channel trim, fixed at 300 mm centres (h=44 mm)	as required	as required	as required	as required	as required	as required
Δ Min. overall depth of system: 200 mm	-	-	-	-	-	-
δ Min. demounting depth: 200 mm (for tile without Impact bracing)	-	-	-	-	-	-

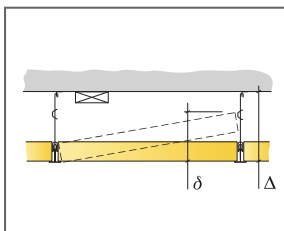

See Quantity Specification

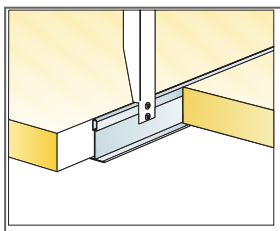

Detail of suspension

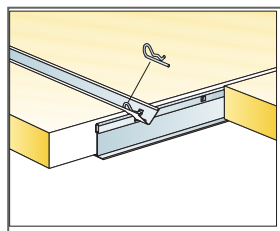

Connection between profiles with split pin

Size, mm	Max live load [N]	Min load bearing capacity [N]
600x600x35	40	160
1200x600x35	40	160
1600x600x35	40	160
1800x600x35	40	160
2000x600x35	40	160
2400x600x35	40	160

Live load/load bearing capacity

# Ecophon Super G™ B

Ecophon Super G™ B has bonded tiles edge to edge, directly to the soffit surface. The bevelled edge creates a narrow groove between each tile to offer a smooth appearance. For applications where the minimum possible overall depth of system is required and there's risk of high mechanical impact.



## SYSTEM RANGE

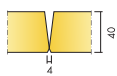

Size, mm	600x600
Direct	•
Thickness (THK)	40
Inst. Diag.	M298, M487



Super G B tile



Section of Super G B system



Super G B system



Section of Super G B system with screws

## Acoustic



### Sound Absorption:

Test results according to EN ISO 354. Classification according to EN ISO 11654, and the single value ratings for Noise Reduction Coefficient, NRC and Sound Absorption Average, SAA according to ASTM C 423.

$\alpha_p$ , Practical sound absorption coefficient

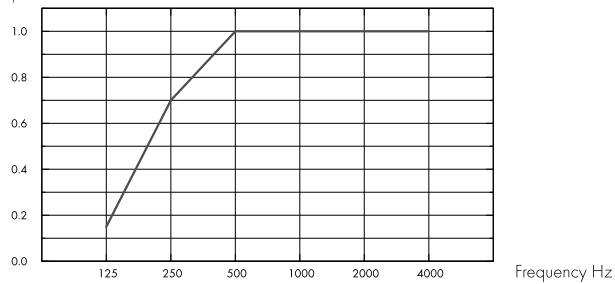

– Super G B 40 mm, 43 mm o.d.s.  
o.d.s = overall depth of system

THK mm	o.d.s. mm	$\alpha_p$ , Practical sound absorption coefficient						$\alpha_w$	Sound absorption class
		125 Hz	250 Hz	500 Hz	1000 Hz	2000 Hz	4000 Hz		
40	43	0.15	0.70	1.00	1.00	1.00	1.00	1.00	A

THK mm	o.d.s. mm	NRC	SAA
40	43	0.95	0.95

## Indoor Air Quality



Certificate / Label	
Eurofins Indoor Air Comfort®	IAC Gold
French VOC	A+



## Carbon footprint



	kg CO <sub>2</sub> equiv/m <sup>2</sup>	Life-cycle stages A1 to C4 from EPD, in conformity with ISO 14025 / EN 15804
Super G B	6,57	

## Circularity



Minimum post-consumer recycled content	58%
Recyclability	Fully recyclable





## Fire safety

Country	Fire standard	Class
Europe	EN 13501-1	A2-s1,d0

The glass wool core of the tiles is tested and classified as non-combustible according to EN ISO 1182.



## Humidity Resistance

Class C, relative humidity 95% and 30°C, according to EN 13964:2014



## Visual appearance

White 085. Nearest NCS colour sample: S 1002-Y. Light reflectance: 78%. (The tiles need to be installed in accordance with the arrows on the back of the tile in order to get optimal visual appearance).



## Cleanability

Daily dusting and vacuum cleaning. Weekly wet wiping.



## Accessibility

The tiles are not demountable.



## Installation

Installed according to installation diagrams, installation guides and drawing aid. For information regarding minimum overall depth of system see quantity specification. Rendered surfaces must have sufficient strength to be able to carry the load imposed by the tiles. If doubts, test gluing should be carried out. The surface should always be dry and clean. For best result the surface should be even. Install tiles according to arrows.



## System weight

	kg/m <sup>2</sup>
Super G B	3,7

Weight information is indicative and subject to variation.



## Mechanical properties

See table regarding the min- and max- load bearing capacities and functional demands. Additional live load has to be fixed to the soffit.



## Impact Resistance

M-sketch	Classification
M298	1A
M487	1A

Tested and classified according to EN 13964 annex D and fulfill the demands corresponding to DIN 18032 part 3. Adding installations to the system might affect the systems impact resistance.



## CE

Ecophon ceiling systems are CE marked according to the European harmonized standard EN13964:2014. CE marked construction products are covered by a Declaration of Performance (DOP) which enables customers and users to easily compare performance of products available on the European market.

## INSTALLATION DIAGRAM (M298) FOR ECOPHON SUPER G B, USING CONNECT ABSORBER GLUE

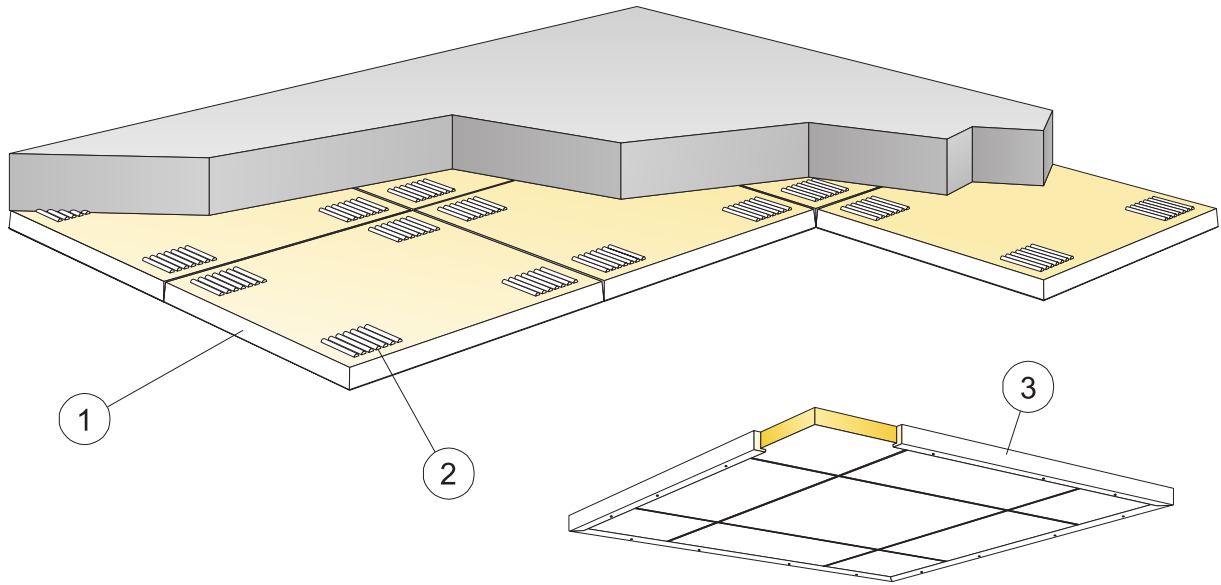

© Ecophon Group

### QUANTITY SPECIFICATION (EXCL. WASTAGE)

	Size, mm
	<b>600x600</b>
1 Super G B	2,8/m <sup>2</sup>
2 Connect Absorber glue (0,25 l/m <sup>2</sup> - 0,4 l/m <sup>2</sup> depending on installation conditions)	as required
3 When installing floating ceilings: Connect Wood trim, L=3000, fixed at 500 mm centres	as required
Use Connect Notched spatula to apply the glue.	-
Δ Min. overall depth of system: 43 mm	-
δ Min. demounting depth: The system is not demountable	-
Cut visible edges should be painted	-

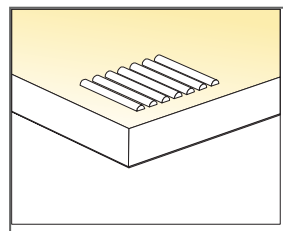
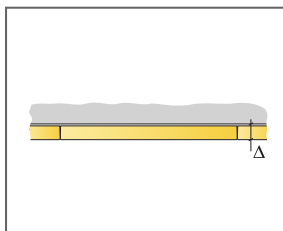

Application of glue

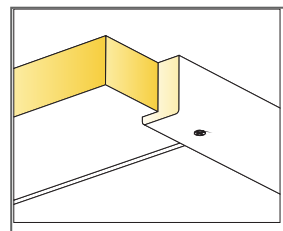

Wood trim for floating installation

Size, mm	Max live load [N]	Min load bearing capacity [N]
600x600x40	-	-

Live load/load bearing capacity

## INSTALLATION DIAGRAM (M487) FOR ECOPHON SUPER G B WITH SCREW AND WASHER



© Ecophon Group

### QUANTITY SPECIFICATION (EXCL. WASTAGE)

		Size, mm
		<b>600x600</b>
1	Super G B	2,8/m <sup>2</sup>
2	Connect Absorber screw SuperGB	11,1/m <sup>2</sup>
	Δ Min, overall depth of system: 43 mm	-
	δ Min, demounting depth: The system is not demountable	-
	Cut visible edges should be painted	-

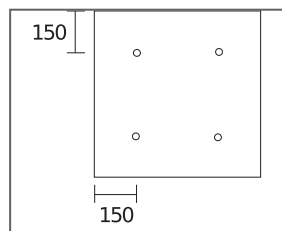
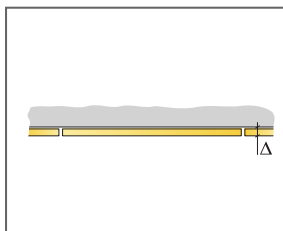

Position of screws size 600x600

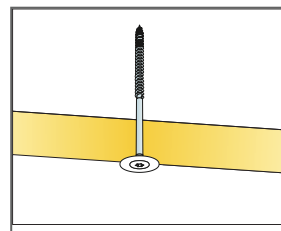

Panel with Connect Absorber screw SuperGB

Size, mm	Max live load [N]	Min load bearing capacity [N]
600x600x40	-	-

Live load/load bearing capacity

# Ecophon Super G™ Plus A

Ecophon Super G™ Plus A has a robust grid system consisting of recessed profiles mounted directly to the soffit or a suspended grid system. For ceilings in sports halls or similar environments with a risk of high mechanical impact.



## SYSTEM RANGE

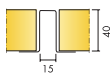

Size, mm	1200x600
Special Fixing	•
Thickness (THK)	40
Inst. Diagr.	M115, M527

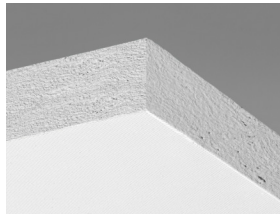

Super G Plus A tile

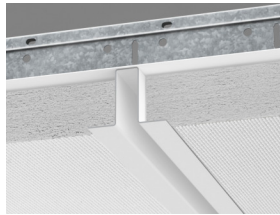

Super G Plus A tile

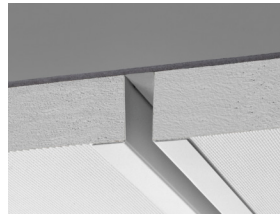

Section of Super G Plus A system direct installation



Section of Super G Plus system suspended installation

## Acoustic



### Sound Absorption:

Test results according to EN ISO 354. Classification according to EN ISO 11654, and the single value ratings for Noise Reduction Coefficient, NRC and Sound Absorption Average, SAA according to ASTM C 423.

$\alpha_p$ , Practical sound absorption coefficient

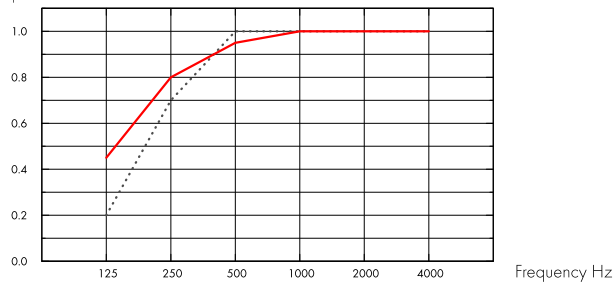

..... Super G Plus A 40 mm, 40 mm o.d.s.  
 — Super G Plus A 40 mm, 200 mm o.d.s.  
 o.d.s = overall depth of system

THK mm	o.d.s. mm	$\alpha_p$ , Practical sound absorption coefficient						$\alpha_w$	Sound absorption class
		125 Hz	250 Hz	500 Hz	1000 Hz	2000 Hz	4000 Hz		
40	40	0.20	0.70	1.00	1.00	1.00	1.00	1.00	A
40	200	0.45	0.80	0.95	1.00	1.00	1.00	1.00	A

THK mm	o.d.s. mm	NRC	SAA
40	40	0.95	0.95
40	200	0.90	0.89
40	400	0.85	0.87

## Indoor Air Quality



Certificate / Label	
Eurofins Indoor Air Comfort®	IAC Gold
French VOC	A+



## Carbon footprint



	kg CO <sub>2</sub> equiv/m <sup>2</sup>	Life-cycle stages A1 to C4 from EPD, in conformity with ISO 14025 / EN 15804
Super G Plus A	7,73	

## Circularity



Minimum post-consumer recycled content	57%
Recyclability	Fully recyclable



## Fire safety

Country	Class
Europe	EN 13501-1 A2-s1,d0

The glass wool core of the tiles is tested and classified as non-combustible according to EN ISO 1182.



## Humidity Resistance

Class C, relative humidity 95% and 30°C, according to EN 13964:2014



## Visual appearance

White 085. Nearest NCS colour sample: S 1002-Y. Light reflectance: 78%. (The tiles need to be installed in accordance with the arrows on the back of the tile in order to get optimal visual appearance).



## Cleanability

Daily dusting and vacuum cleaning. Weekly wet wiping.



## Accessibility

The tiles are not demountable.



## Installation

Installed according to installation diagrams, installation guides and drawing aid. (The tiles have to be installed according to the arrows on the back of the tile.)



## System weight

	kg/m <sup>2</sup>
Super G Plus A	3,7
Super G Plus A + Connect Grid System	4,7

Weight information is indicative and subject to variation.



## Mechanical properties

See table regarding the min- and max- load bearing capacities and functional demands.



## Impact Resistance

M-sketch	Classification
M115	1A
M527	1A

Tested and classified according to EN 13964 annex D and fulfill the demands corresponding to DIN 18032 part 3. Adding installations to the system might affect the systems impact resistance.



## CE

Ecophon ceiling systems are CE marked according to the European harmonized standard EN13964:2014. CE marked construction products are covered by a Declaration of Performance (DOP) which enables customers and users to easily compare performance of products available on the European market.

## INSTALLATION DIAGRAM (M115) FOR ECOPHON SUPER G PLUS A, DIRECT INSTALLATION

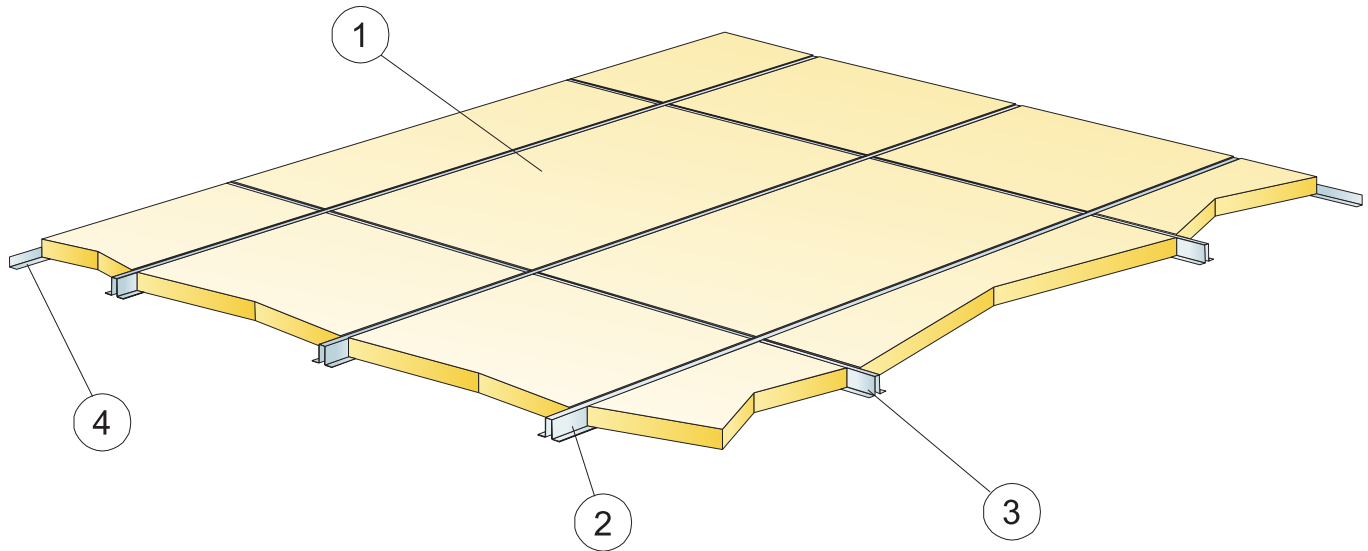

© Ecophon Group

### QUANTITY SPECIFICATION (EXCL. WASTAGE)

	<b>Size, mm</b>
	<b>1200x600</b>
1 Super G Plus A	1,4/m <sup>2</sup>
2 Connect Recessed profile Plus, L=3000 mm, installed at 600 mm centres, fixed at 600 mm centres	1,7m/m <sup>2</sup>
3 Connect Recessed profile Plus, L=576 mm, installed at 1200 mm centres	0,8m/m <sup>2</sup>
4 Connect Angle trim, fixed at 300 mm centres	as required
Δ Min. overall depth of system: 42 mm	-
δ Min. demounting depth: The system is not demountable	-

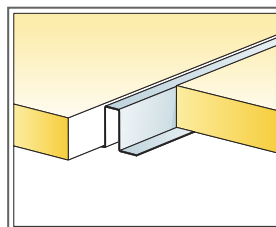
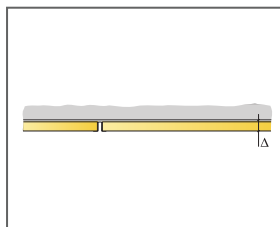

Installation with recessed profile

Size, mm	Max live load [N]	Min load bearing capacity [N]
1200x600x40	50	220

Live load/load bearing capacity

## INSTALLATION DIAGRAM (M527) FOR ECOPHON SUPER G PLUS A, SUSPENDED INSTALLATION

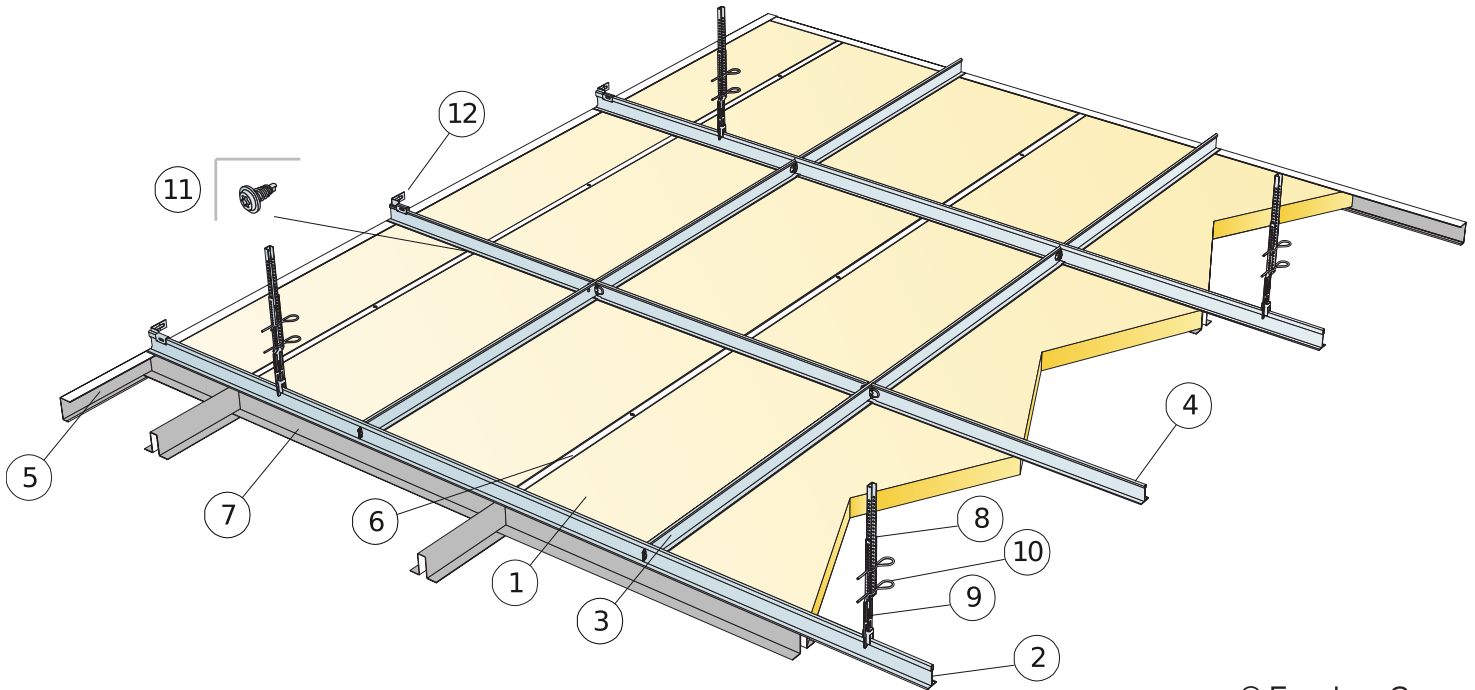

© Ecophon Group

### QUANTITY SPECIFICATION (EXCL. WASTAGE)

		Size, mm
		<b>1200x600</b>
1	Super G Plus A	1,4/m <sup>2</sup>
2	Connect T24 Main runner, installed at 600 mm centres	0,9m/m <sup>2</sup>
3	Connect T24 Cross Tee, L=1200 mm, installed at 600 mm centres	1,7m/m <sup>2</sup>
4	Connect T24 Cross Tee, L=600 mm	0,9m/m <sup>2</sup>
5	Connect Channel trim, fixed at 300 mm centres (h=44 mm)	as required
6	Connect Recessed profile Plus, L=3000 mm, installed at 600 mm centres, fixed at 600 mm centres	1,7m/m <sup>2</sup>
7	Connect Recessed profile Plus, L=576 mm, installed at 1200 mm centres	0,8m/m <sup>2</sup>
8	Connect Nonius hanger upper, installed at 1200 mm centres	0,7/m <sup>2</sup>
9	Connect Nonius hanger lower, installed at 1200 mm centres	0,7/m <sup>2</sup>
10	Connect Split pin (2/hanger)	1,4/m <sup>2</sup>
11	Connect Installation screw P, installed at 400 mm centres	4,4/m <sup>2</sup>
12	Connect Wall Bracket for Main runners	1/second row of Main runner
Δ Min. overall depth of system: Δ 270 mm		-

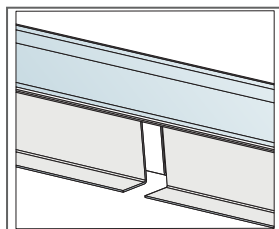

Installation with recessed profile

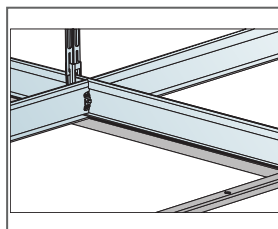

Installation with recessed profile and C-profile

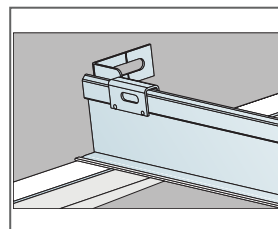

Connect C-profile plus with Connect Wall bracket plus

Size, mm	Max live load [N]	Min load bearing capacity [N]
1200x600x40	20	220

Live load/load bearing capacity