

# Ecophon Solo™ Square

Solo Square is a free hanging unit, offering high level design possibilities. Three different suspension systems offer opportunities to create several layers and angles. Suitable when the room volume should be maintained or when it's not possible to install a wall-to-wall ceiling.



Impol Papier, Bardo (Dobroskiel), Poland

## SYSTEM RANGE

<input type="checkbox"/>	Size, mm	1200x1200
	Special Fixing	•
	Thickness (THK)	40
	Inst. Diagr.	M402, M507

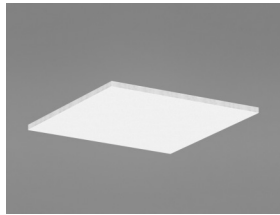

Solo Square

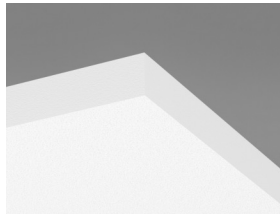

Solo panel

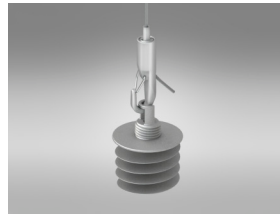

Suspension with Connect Adjustable wire hanger and Connect Absorber anchor



Suspension with Connect Absorber bracket and Connect Absorber anchor

## Acoustic



The values in the diagram refer to a single unit. If the units are arranged in a cluster with distances between units less than 0,5 meters, the Aeq per unit will be slightly reduced.

### Sound Absorption:

Test results according to EN ISO 354.

$A_{eq}$  Equivalent absorption area per unit (m<sup>2</sup> sabin)

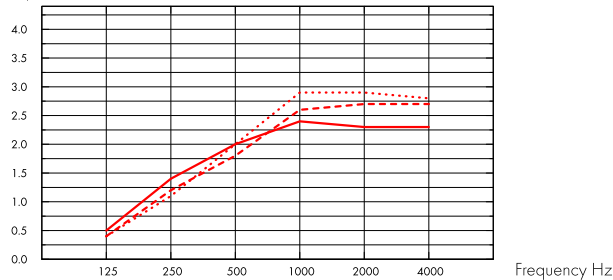

- Solo Square 1200x1200, 200 mm o.d.s.
  - - - Solo Square 1200x1200, 400 mm o.d.s.
  - ... Solo Square 1200x1200, 1000 mm o.d.s.
- o.d.s = overall depth of system

THK mm	o.d.s. mm	$A_{eq}$ Equivalent absorption area per unit (m <sup>2</sup> sabin)					
		125 Hz	250 Hz	500 Hz	1000 Hz	2000 Hz	4000 Hz
40	200	0.5	1.4	2.0	2.4	2.3	2.3
40	400	0.4	1.2	1.8	2.6	2.7	2.7
40	1000	0.4	1.1	2.0	2.9	2.9	2.8

## Indoor Air Quality



Certificate / Label

Eurofins Indoor Air Comfort®

IAC Gold

French VOC

A+



## Cradle to Cradle Certified®



This product is Cradle to Cradle Certified® at Bronze level (version 4.0).



## Material Health



This product has received a C2C Certified Material Health Certificate™ at the Silver level (standard version 4.0). The C2C Certified Material Health Certificate™ is a verification of the health and safety of a product's composition using the Material Health requirements of the Cradle-to-Cradle Certified Product Standard.



## Carbon footprint

	kg CO <sub>2</sub> equiv/m <sup>2</sup>
Solo Square	9,37

Life-cycle stages A1 to C4 from EPD, in conformity with ISO 14025 / EN 15804



### Circularity

Minimum post-consumer recycled content	57%
Recyclability	Fully recyclable



### Fire safety

Country	Fire standard	Class
Europe	EN 13501-1	A2-s1,d0

The glass wool core of the tiles is tested and classified as non-combustible according to EN ISO 1182.



### Humidity Resistance

Class C, relative humidity 95% and 30°C, according to EN 13964:2014



### Visual appearance

White Frost, nearest NCS colour sample S 0500-N, 85% light reflectance. Gloss < 1.



### Cleanability

Daily dusting and vacuum cleaning. Weekly wet wiping.



### Accessibility

The tiles are demountable.



### Installation

Installed according to installation diagrams, installation guides and drawing aid. For information regarding minimum overall depth of system see quantity specification.



### System weight

	kg/m <sup>2</sup>
Solo Square	4,6
Solo Freedom	4,6

Weight information is indicative and subject to variation.



### Mechanical properties

The tile can take both point loads and distributed loads. See Functional demands, Mechanical properties at [www.ecophon.com](http://www.ecophon.com).



### CE

Ecophon ceiling systems are CE marked according to the European harmonized standard EN 13964:2014. CE marked construction products are covered by a Declaration of Performance (DOP) which enables customers and users to easily compare performance of products available on the European market.

## INSTALLATION DIAGRAM (M402) FOR ECOPHON SOLO SQUARE

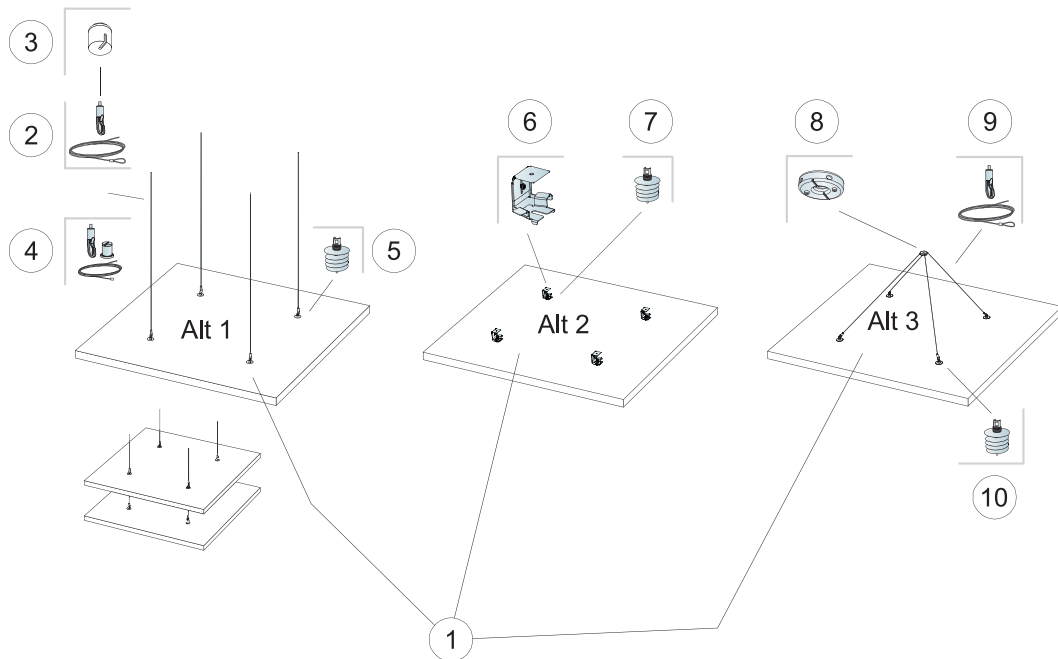

© Saint-Gobain Ecophon AB

### QUANTITY SPECIFICATION (EXCL. WASTAGE)

		Size, mm
		1200x1200
1	Solo Square	1,44m <sup>2</sup> /panel
2	Connect Adjustable wire hanger (Alt 1)	4/panel
3	Connect Covering cup (Alt 1, Optional)	4/panel
4	Connect Adjustable wire kit (Alt 1, Optional)	4/panel
5	Connect Absorber anchor (Alt 1)	4/panel
6	Connect Absorber bracket (Alt 2)	4/panel
7	Connect Absorber anchor (Alt 2)	4/panel
8	Connect One-point fixing (Alt 3)	1/panel
9	Connect Adjustable wire hanger (Alt 3)	2/panel
10	Connect Absorber anchor (Alt 3)	4/panel
Δ Min. overall depth of system: Δ1 140 mm / Δ2 90 mm / Δ3 500 mm		-

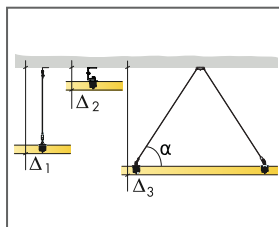

See Quantity specification

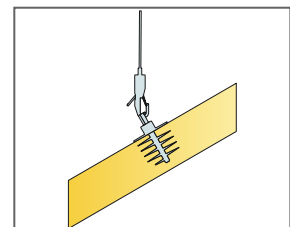
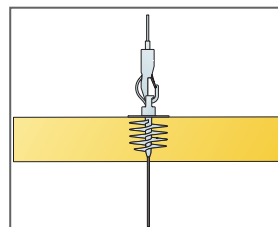
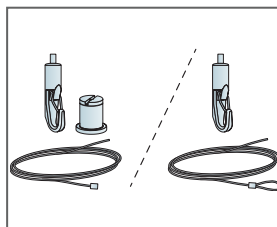

## INSTALLATION DIAGRAM (M507) FOR ECOPHON SOLO SQUARE KIT

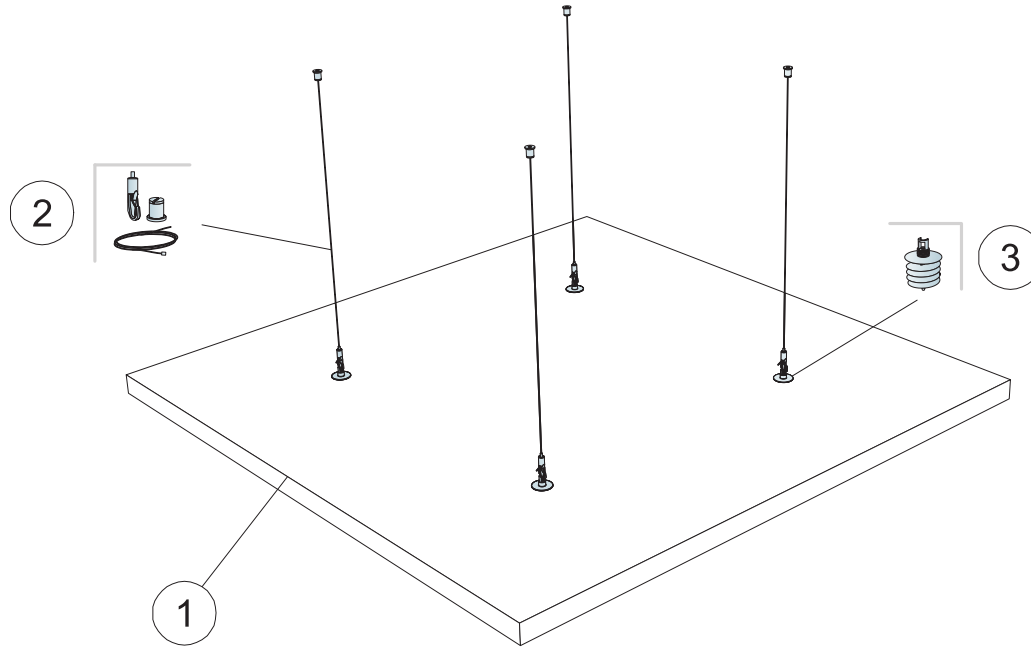

### QUANTITY SPECIFICATION (EXCL. WASTAGE)

		Size, mm
		1200x1200
1	Solo Square Kit	1,44m <sup>2</sup> /panel
2	Connect Adjustable wire kit 1500mm (included)	-
3	Connect Absorber anchor (included)	-
Δ Min. overall depth of system: Δ 140 mm		-
To install Connect Absorber Anchor, use Connect Absorber Anchor Bit.		-

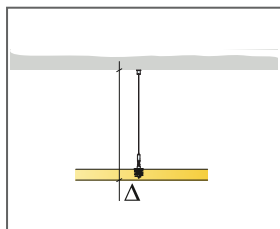

See Quantity specification

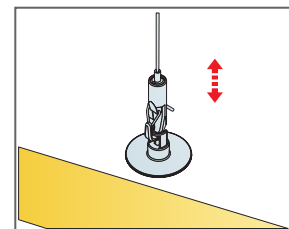
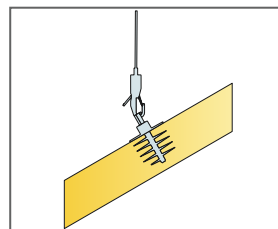
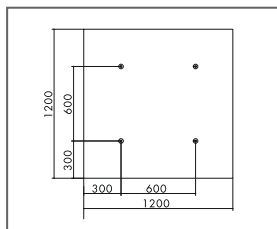

Easily adjustable suspension with Connect Adjustable wire hanger

# Ecophon Solo™ Rectangle

Solo Rectangle is a free hanging unit, offering high level design possibilities. Three different suspension systems offer opportunities to create several layers and angles. Suitable when the room volume should be maintained or when it's not possible to install a wall-to-wall ceiling.



M30 Achilleen, Oisterwijk, Netherlands

## SYSTEM RANGE

	Size, mm	1200x600	1800x1200	2400x1200	3000x1200
	Special Fixing	•	•	•	•
	Thickness (THK)	40	40	40	40
	Inst. Diagr.	M637	M404, M506	M406, M407, M506	M408

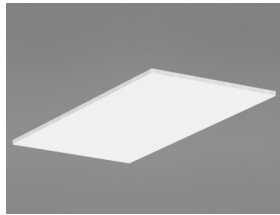

Solo Rectangle

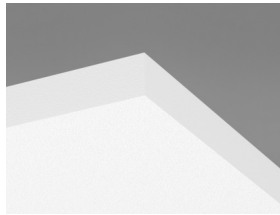

Solo panel

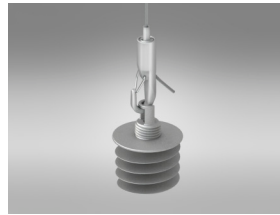

Suspension with Connect Adjustable wire hanger and Connect Absorber anchor



Suspension with Connect Absorber bracket and Connect Absorber anchor

## Acoustic



The values in the diagram refer to a single unit. If the units are arranged in a cluster with distances between units less than 0,5 meters, the Aeq per unit will be slightly reduced.

### Sound Absorption:

Test results according to EN ISO 354.

$A_{eq}$ , Equivalent absorption area per unit (m<sup>2</sup> sabin)

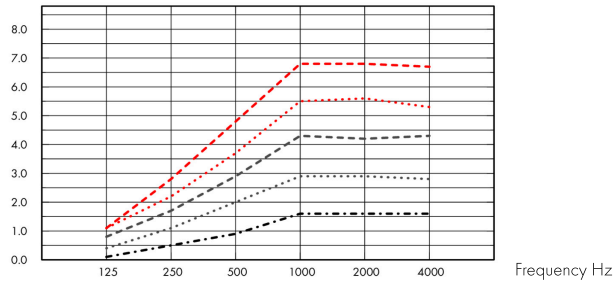

- ..... Solo Rectangle 2400x1200, 1000 mm o.d.s.
  - Solo Rectangle 1800x1200, 1000 mm o.d.s.
  - ..... Solo Rectangle 2400x600, 1000 mm o.d.s.
  - Solo Rectangle 3000x1200, 1000 mm o.d.s.
  - Solo Rectangle 1200x600, 1000 mm o.d.s.
- o.d.s = overall depth of system

	THK mm	o.d.s. mm	$A_{eq}$ , Equivalent absorption area per unit (m <sup>2</sup> sabin)					
			125 Hz	250 Hz	500 Hz	1000 Hz	2000 Hz	4000 Hz
2400x1200	40	200	1.3	2.8	3.5	4.1	4.1	3.9
2400x1200	40	400	1.2	2.4	3.3	4.7	4.9	4.7
2400x1200	40	1000	1.1	2.2	3.7	5.5	5.6	5.3
1800x1200	40	200	0.6	2.0	2.9	3.4	3.3	3.1
1800x1200	40	400	0.8	1.9	2.6	3.7	3.7	3.6
1800x1200	40	1000	0.8	1.7	2.9	4.3	4.2	4.3
2400x600	40	200	0.5	1.4	2.0	2.4	2.3	2.3
2400x600	40	400	0.4	1.2	1.8	2.6	2.7	2.7
2400x600	40	1000	0.4	1.1	2.0	2.9	2.9	2.8
3000x1200	40	200	1.1	3.3	4.4	5.1	5.1	5.0
3000x1200	40	400	1.2	3.0	4.2	5.8	5.8	5.7
3000x1200	40	1000	1.1	2.8	4.8	6.8	6.8	6.7
1200x600	40	200	0.1	0.7	1.0	1.3	1.3	1.4
1200x600	40	400	0.2	0.5	0.9	1.4	1.5	1.6
1200x600	40	1000	0.1	0.5	0.9	1.6	1.6	1.6

## Indoor Air Quality



Certificate / Label

Eurofins Indoor Air Comfort®

IAC Gold

French VOC

A+





## Cradle to Cradle Certified®



This product is Cradle to Cradle Certified® at Bronze level (version 4.0).



## Material Health



This product has received a C2C Certified Material Health Certificate™ at the Silver level (standard version 4.0). The C2C Certified Material Health Certificate™ is a verification of the health and safety of a product's composition using the Material Health requirements of the Cradle-to-Cradle Certified Product Standard.



## Carbon footprint

	kg CO <sub>2</sub> equiv/m <sup>2</sup>	Life-cycle stages A1 to C4 from EPD, in conformity with ISO 14025 / EN 15804
Solo Rectangle	9,12	



## Circularity

Minimum post-consumer recycled content	57%
Recyclability	Fully recyclable



## Fire safety

Country	Fire standard	Class
Europe	EN 13501-1	A2-s1,d0

The glass wool core of the tiles is tested and classified as non-combustible according to EN ISO 1182.



## Humidity Resistance

Class C, relative humidity 95% and 30°C, according to EN 13964:2014



## Visual appearance

White Frost, nearest NCS colour sample S 0500-N, 85% light reflectance. Gloss < 1.



## Cleanability

Daily dusting and vacuum cleaning. Weekly wet wiping.



## Accessibility

The tiles are demountable.



## Installation

Installed according to installation diagrams, installation guides and drawing aid. For information regarding minimum overall depth of system see quantity specification.



## System weight

	kg/m <sup>2</sup>	Weight information is indicative and subject to variation.
Solo Rectangle	4,7	





### **Mechanical properties**

---

The tile can take both point loads and distributed loads. See Functional demands, Mechanical properties at [www.ecophon.com](http://www.ecophon.com).



### **CE**

---

Ecophon ceiling systems are CE marked according to the European harmonized standard EN 13964:2014. CE marked construction products are covered by a Declaration of Performance (DOP) which enables customers and users to easily compare performance of products available on the European market.

## INSTALLATION DIAGRAM (M404) FOR ECOPHON SOLO RECTANGLE 1800X1200

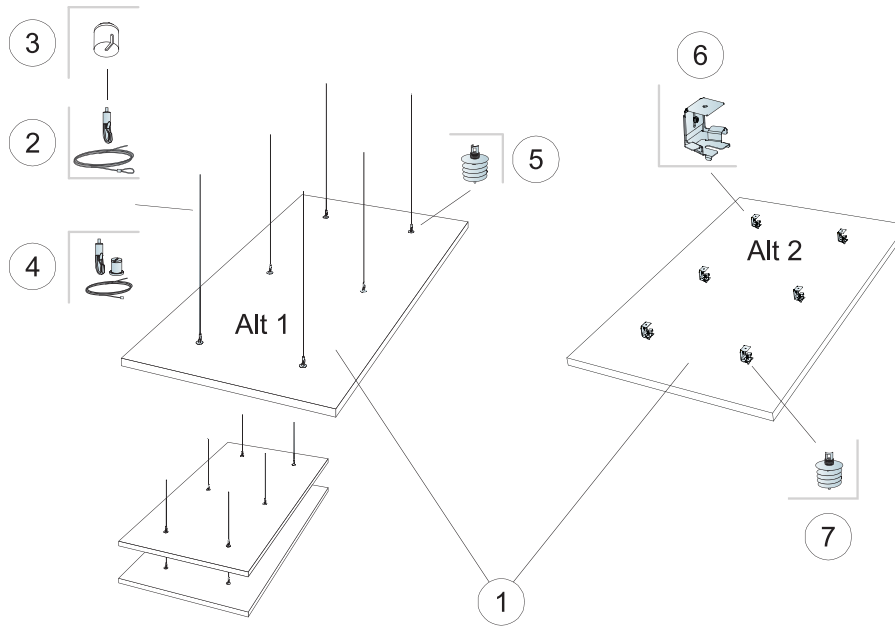

© Saint-Gobain Ecophon AB

### QUANTITY SPECIFICATION (EXCL. WASTAGE)

		Size, mm
		1800x1200
1	Solo Rectangle	2,16m <sup>2</sup> /panel
2	Connect Adjustable wire hanger (Alt 1)	6/panel
3	Connect Covering cup (Alt 1, Optional)	6/panel
4	Connect Adjustable wire kit (Alt 1, Optional)	6/panel
5	Connect Absorber anchor (Alt 1)	6/panel
6	Connect Absorber bracket (Alt 2)	6/panel
7	Connect Absorber anchor (Alt 3)	6/panel
Δ Min. overall depth of system: Δ1 140 mm / Δ2 90 mm		-

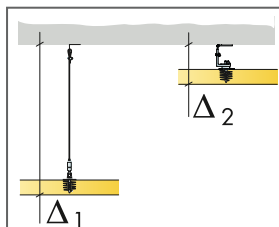

See Quantity specification

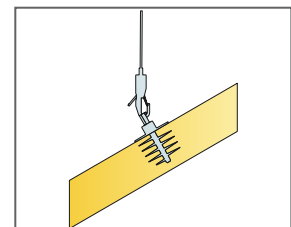
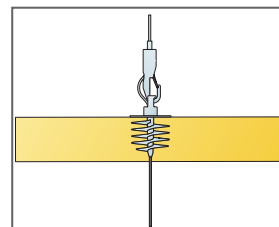
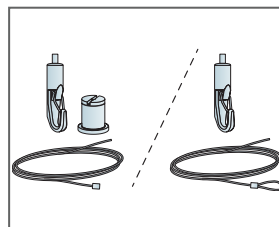

## INSTALLATION DIAGRAM (M406) FOR ECOPHON SOLO RECTANGLE 2400X1200

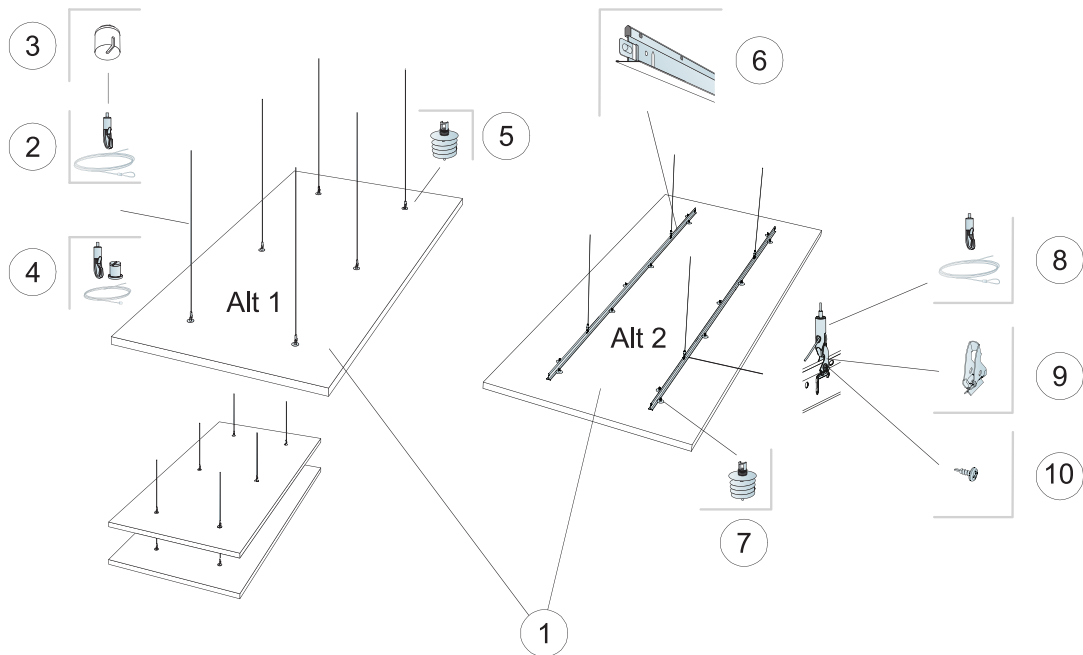

© Saint-Gobain Ecophon AB

### QUANTITY SPECIFICATION (EXCL. WASTAGE)

		Size, mm
		<b>2400x1200</b>
1	Solo Rectangle	2,88m <sup>2</sup> /panel
2	Connect Adjustable wire hanger (Alt 1)	6/panel
3	Connect Covering cup (Alt 1, Optional)	6/panel
4	Connect Adjustable wire kit (Alt 1, Optional)	6/panel
5	Connect Absorber anchor (Alt 1)	6/panel
6	Connect T24 Main runner (Alt 2)	2/panel
7	Connect Absorber anchor (Alt 2)	14/panel
8	Connect Adjustable wire hanger (Alt 2)	4/panel
9	Connect Hanger Clip (Alt 2)	4/panel
10	Connect Installation screw BR	4/panel
Δ Min. overall depth of system: Δ1 140 mm / Δ2 200 mm		-

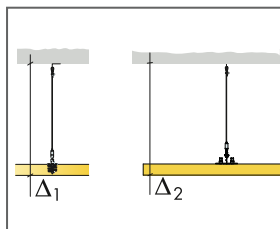

See Quantity specification

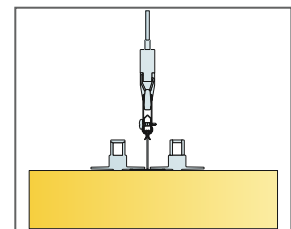
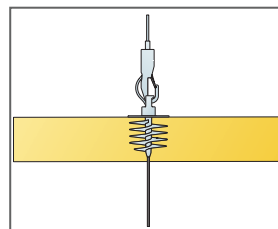
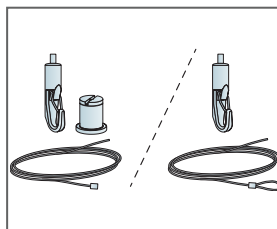

Installation with T24 Main runner

## INSTALLATION DIAGRAM (M407) FOR ECOPHON SOLO RECTANGLE 2400X1200

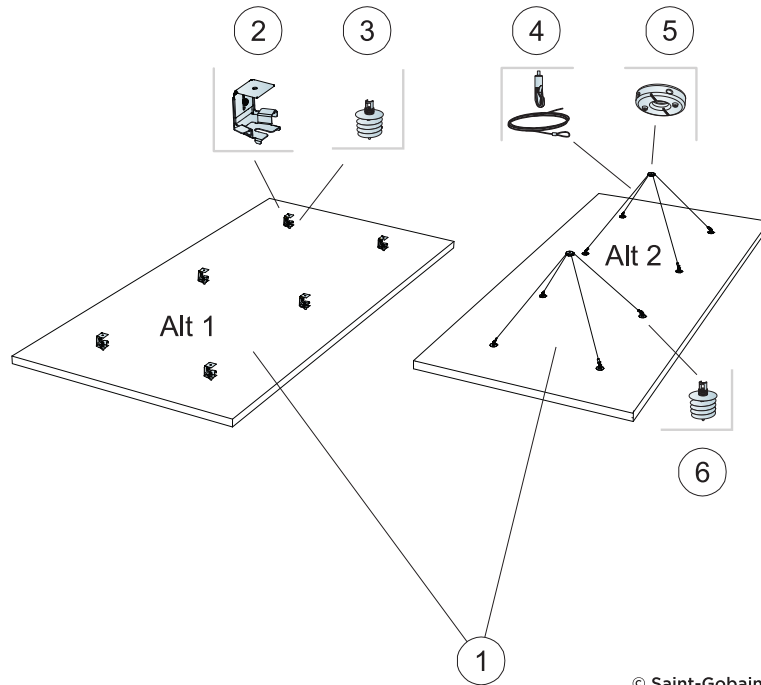

© Saint-Gobain Ecophon AB

### QUANTITY SPECIFICATION (EXCL. WASTAGE)

		Size, mm
		<b>2400x1200</b>
1	Solo Rectangle	2,88m <sup>2</sup> /panel
2	Connect Absorber bracket (Alt 1)	6/panel
3	Connect Absorber anchor (Alt 1)	6/panel
4	Connect Adjustable wire hanger (Alt 2)	4/panel
5	Connect One-point fixing (Alt 2)	2/panel
6	Connect Absorber anchor (Alt 2)	8/panel
Δ Min. overall depth of system: Δ1 90 mm / Δ2 500 mm		-

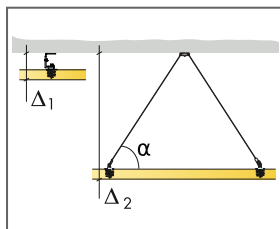

See Quantity specification

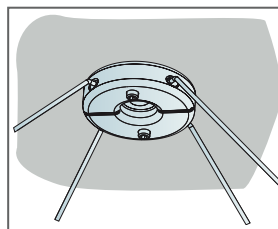

Detail of One-point fixing

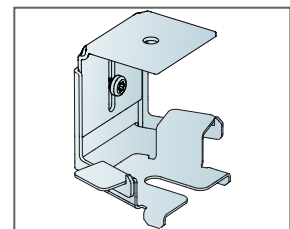

Details of Absorber bracket. Overall depth of system between 90-130mm

## INSTALLATION DIAGRAM (M408) FOR ECOPHON SOLO RECTANGLE 3000X1200

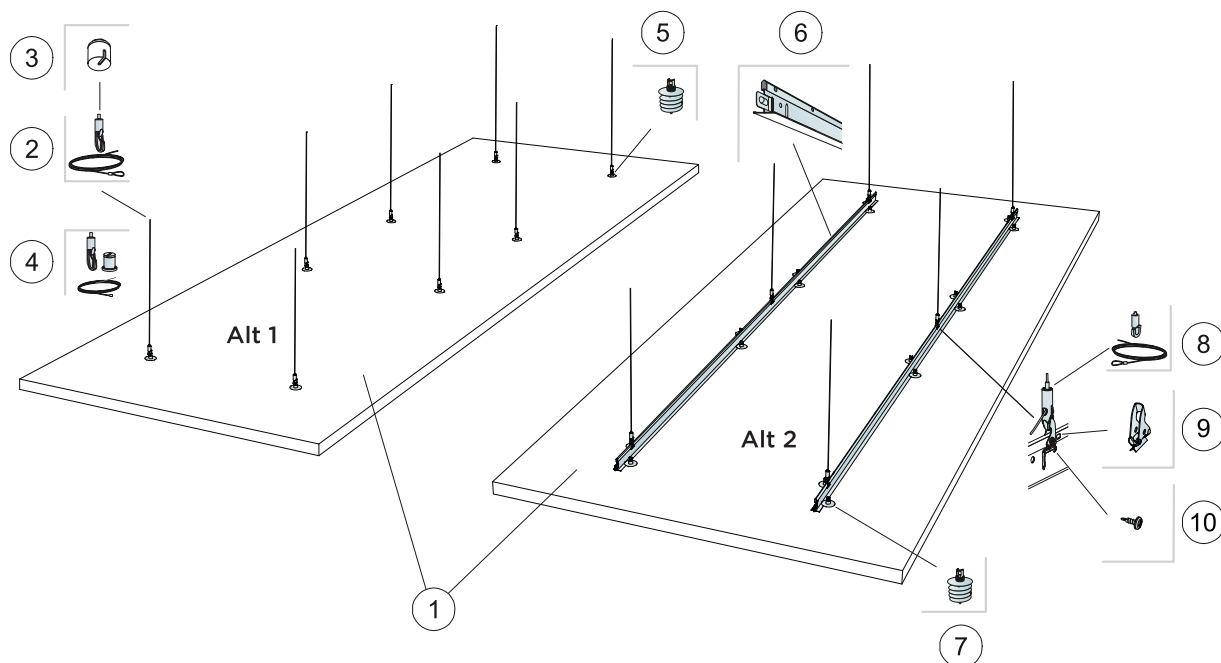

© Saint-Gobain Ecophon AB

### QUANTITY SPECIFICATION (EXCL. WASTAGE)

		Size, mm
		<b>3000x1200</b>
1	Solo Rectangle	3,6m <sup>2</sup> /panel
2	Connect Adjustable wire hanger (Alt 1)	8/panel
3	Connect Covering cup (Alt 1, Optional)	8/panel
4	Connect Adjustable wire kit (Alt 1, Optional)	8/panel
5	Connect Absorber anchor (Alt 1)	8/panel
6	Connect T24 Main runner	2/panel
7	Connect Absorber anchor (Alt 2)	16/panel
8	Connect Adjustable wire hanger (Alt 2)	6/panel
9	Connect Hanger Clip (Alt 2)	6/panel
10	Connect Installation screw BR	6/panel
Δ Min. overall depth of system: Δ1 140 mm / Δ2 200 mm		-

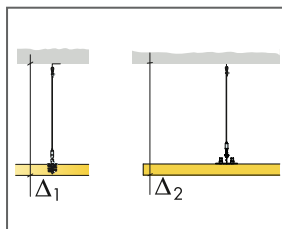

See Quantity specification

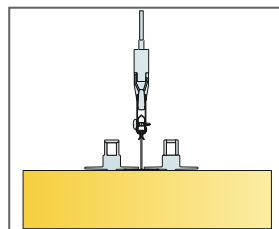
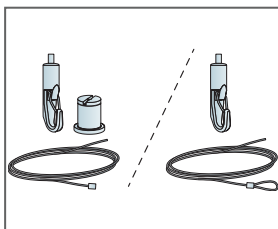

Installation with T24 Main runner

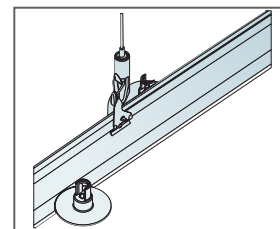

Installation of hanger clips

## INSTALLATION DIAGRAM (M506) FOR ECOPHON SOLO RECTANGLE KIT

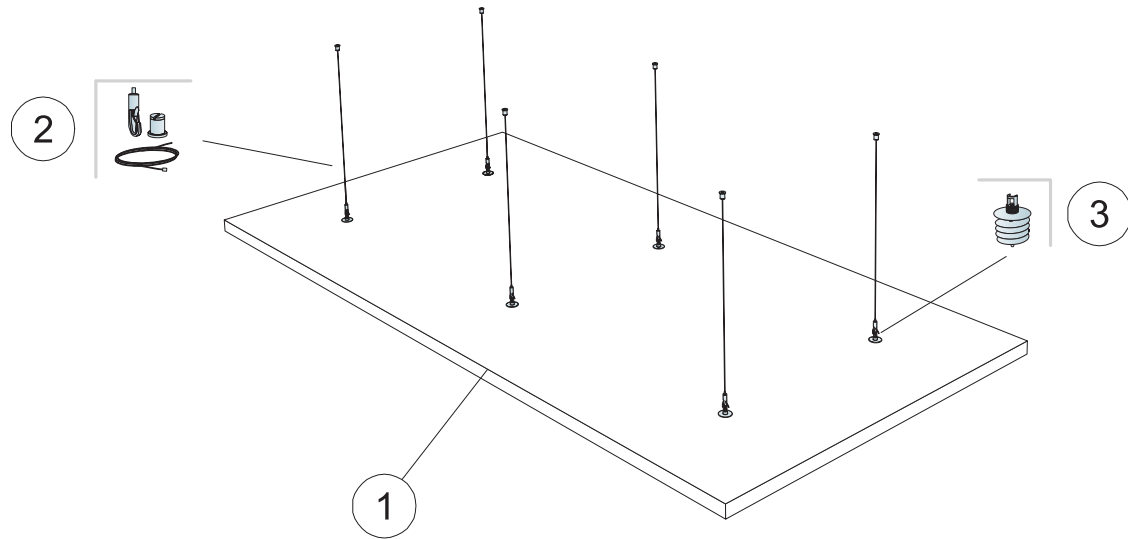

### QUANTITY SPECIFICATION (EXCL. WASTAGE)

	Size, mm	
	1800x1200	2400x1200
1 Solo Rectangle Kit	2,16m <sup>2</sup> /panel	2,88m <sup>2</sup> /panel
2 Connect Adjustable wire kit 1500mm (included)	-	-
3 Connect Absorber anchor (included)	-	-
Δ Min. overall depth of system: Δ 140 mm	-	-
To install Connect Absorber Anchor, use Connect Absorber Anchor Bit.	-	-

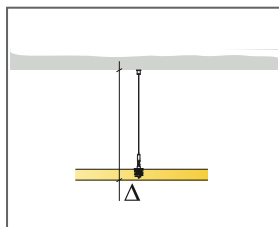

See Quantity specification

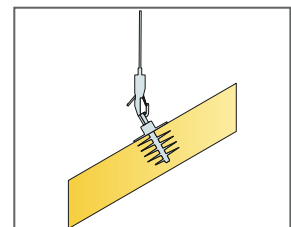
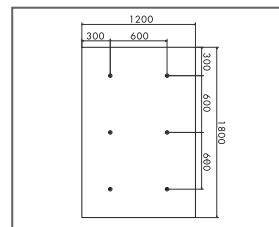
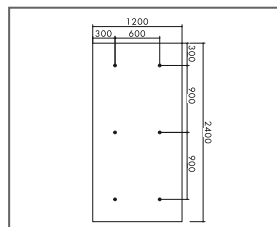

## INSTALLATION DIAGRAM (M637) FOR ECOPHON SOLO RECTANGLE

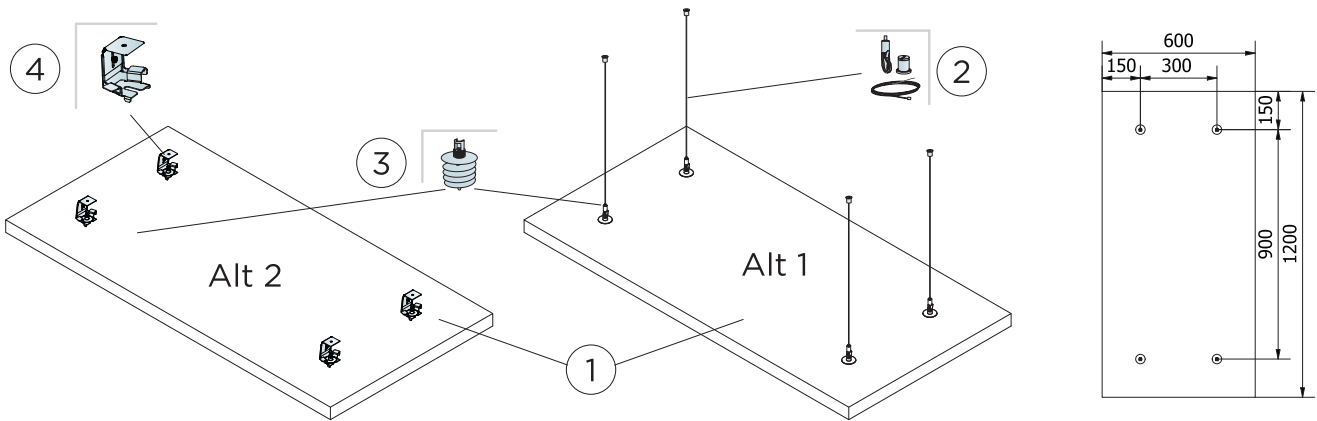

### QUANTITY SPECIFICATION (EXCL. WASTAGE)

		Size, mm
		<b>1200x600</b>
1	Solo Rectangle	0,72m <sup>2</sup> /panel
2	Connect Adjustable wire kit (Alt 1)	4/panel
3	Connect Absorber anchor	4/panel
4	Connect Absorber bracket (Alt 2)	4/panel
Δ Min. overall depth of system: Δ 140 mm		-
To install Connect Absorber Anchor, use Connect Absorber Anchor Bit.		-

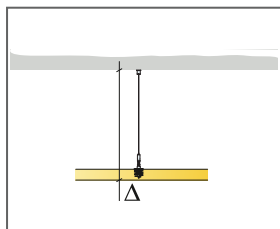

See Quantity specification

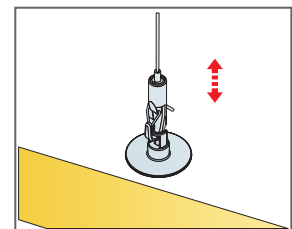
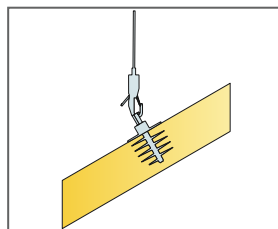

Easily adjustable suspension with Connect Adjustable wire hanger

# Ecophon Solo™ Circle

Solo Circle is a free hanging unit, offering high level design possibilities. Three different suspension systems offer opportunities to create several layers and angles. Suitable when the room volume should be maintained or when it's not possible to install a wall-to-wall ceiling.



Asia Zareca, Warsaw, Poland

## SYSTEM RANGE

 Size, mm	Ø800	Ø1200
Special Fixing	•	•
Thickness (THK)	40	40
Inst. Diagr.	M411	M410



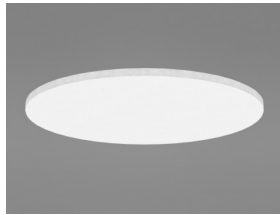

Solo Circle

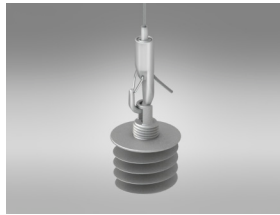

Suspension with Connect Adjustable wire hanger and Connect Absorber anchor



Suspension with Connect Absorber bracket and Connect Absorber anchor

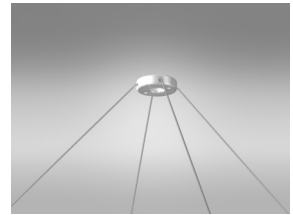

Suspension with One-point fixing

## Acoustic



The values in the diagram refer to a single unit. If the units are arranged in a cluster with distances between units less than 0,5 meters, the Aeq per unit will be slightly reduced.

### Sound Absorption:

Test results according to EN ISO 354.

$A_{eq}$ , Equivalent absorption area per unit (m<sup>2</sup> sabin)

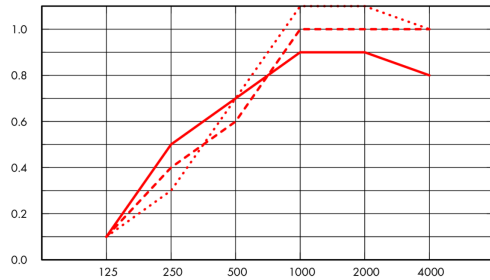

- Solo Circle Ø800, 200 mm o.d.s.
  - - - Solo Circle Ø800, 400 mm o.d.s.
  - · · Solo Circle Ø800, 1000 mm o.d.s.
- o.d.s = overall depth of system

Frequency Hz

$A_{eq}$ , Equivalent absorption area per unit (m<sup>2</sup> sabin)

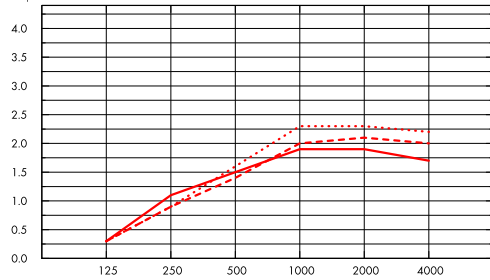

- Solo Circle Ø1200, 200 mm o.d.s.
  - - - Solo Circle Ø1200, 400 mm o.d.s.
  - · · Solo Circle Ø1200, 1000 mm o.d.s.
- o.d.s = overall depth of system

Frequency Hz

	THK mm	o.d.s. mm	$A_{eq}$ , Equivalent absorption area per unit (m <sup>2</sup> sabin)					
			125 Hz	250 Hz	500 Hz	1000 Hz	2000 Hz	4000 Hz
Ø800	40	200	0.1	0.5	0.7	0.9	0.9	0.8
Ø800	40	400	0.1	0.4	0.6	1.0	1.0	1.0
Ø800	40	1000	0.1	0.3	0.7	1.1	1.1	1.0

	THK mm	o.d.s. mm	$A_{eq}$ , Equivalent absorption area per unit (m <sup>2</sup> sabin)					
			125 Hz	250 Hz	500 Hz	1000 Hz	2000 Hz	4000 Hz
Ø1200	40	200	0.3	1.1	1.5	1.9	1.9	1.7
Ø1200	40	400	0.3	0.9	1.4	2.0	2.1	2.0
Ø1200	40	1000	0.3	0.9	1.6	2.3	2.3	2.2



## Indoor Air Quality

Certificate / Label	
Eurofins Indoor Air Comfort®	IAC Gold
French VOC	A+



## Cradle to Cradle Certified®



This product is Cradle to Cradle Certified® at Bronze level (version 4.0).



## Material Health



This product has received a C2C Certified Material Health Certificate™ at the Silver level (standard version 4.0). The C2C Certified Material Health Certificate™ is a verification of the health and safety of a product's composition using the Material Health requirements of the Cradle-to-Cradle Certified Product Standard.



## Carbon footprint

kg CO <sub>2</sub> equiv/m <sup>2</sup>	
Solo Circle	10,35

Life-cycle stages A1 to C4 from EPD, in conformity with ISO 14025 / EN 15804



## Circularity

Minimum post-consumer recycled content	57%
Recyclability	Fully recyclable



## Fire safety

Country	Fire standard	Class
Europe	EN 13501-1	A2-s1,d0

The glass wool core of the tiles is tested and classified as non-combustible according to EN ISO 1182.



## Humidity Resistance

Class C, relative humidity 95% and 30°C, according to EN 13964:2014



## Visual appearance

White Frost, nearest NCS colour sample S 0500-N, 85% light reflectance. Gloss < 1.



## Cleanability

Daily dusting and vacuum cleaning. Weekly wet wiping.



## Accessibility

The tiles are demountable.



## Installation

---

Installed according to installation diagrams, installation guides and drawing aid. For information regarding minimum overall depth of system see quantity specification.



## System weight

---

	kg/m <sup>2</sup>	Weight information is indicative and subject to variation.
Solo Circle	4,6	



## Mechanical properties

---

The tile can take both point loads and distributed loads. See Functional demands, Mechanical properties at [www.ecophon.com](http://www.ecophon.com).



## CE

---

Ecophon ceiling systems are CE marked according to the European harmonized standard EN 13964:2014. CE marked construction products are covered by a Declaration of Performance (DOP) which enables customers and users to easily compare performance of products available on the European market.

## INSTALLATION DIAGRAM (M410) FOR ECOPHON SOLO CIRCLE

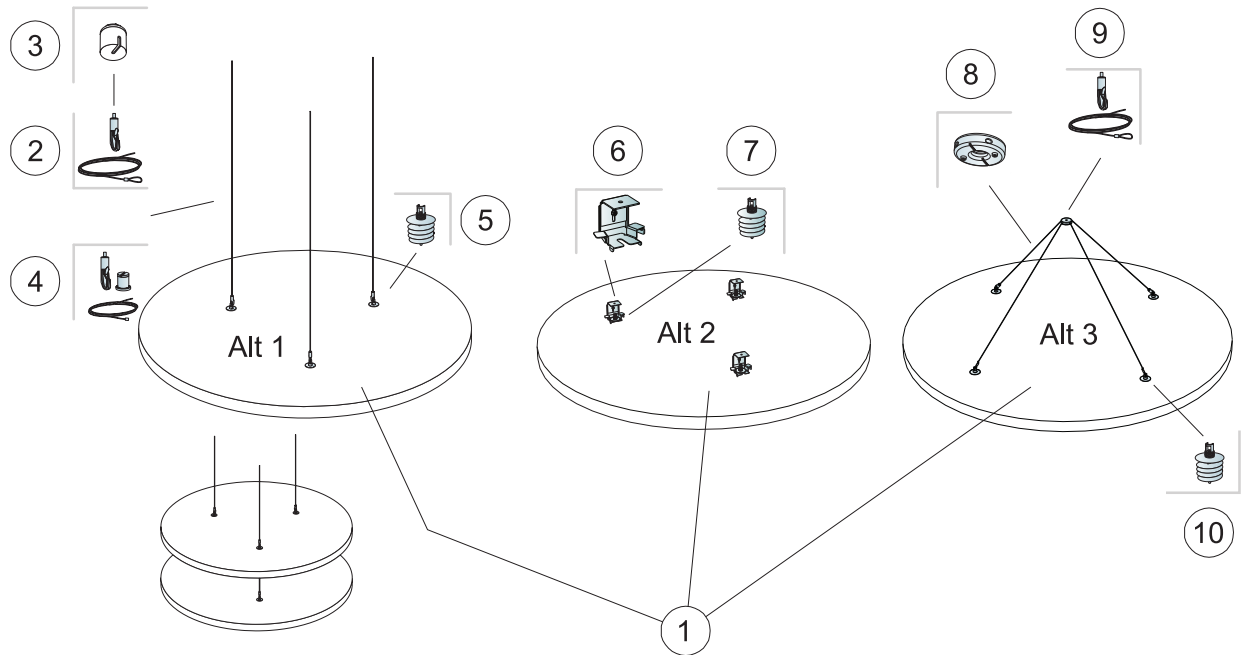

© Saint-Gobain Ecophon AB

### QUANTITY SPECIFICATION (EXCL. WASTAGE)

		Size, mm
		Ø1200
1	Solo Circle	1,13m <sup>2</sup> /panel
2	Connect Adjustable wire hanger (Alt 1)	3/panel
3	Connect Covering cup (Alt 1, Optional)	3/panel
4	Connect Adjustable wire Kit (Alt 1, Optional)	3/panel
5	Connect Absorber anchor (Alt 1)	3/panel
6	Connect Absorber bracket (Alt 2)	3/panel
7	Connect Absorber anchor (Alt 2)	3/panel
8	Connect One-point fixing (Alt 3)	1/panel
9	Connect Adjustable wire hanger (Alt 3)	2/panel
10	Connect Absorber anchor (Alt 3)	4/panel
Δ Min. overall depth of system: Δ1 140 mm / Δ2 90 mm / Δ3 500 mm		-

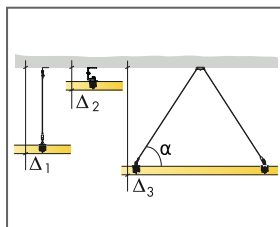

See Quantity specification

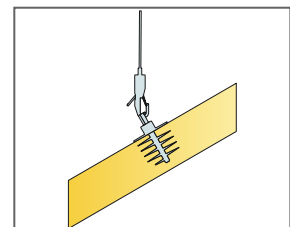
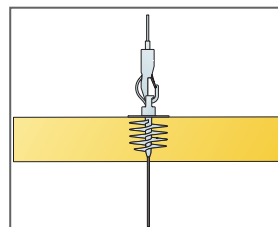
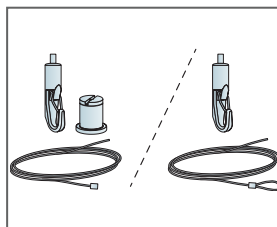

## INSTALLATION DIAGRAM (M411) FOR ECOPHON SOLO CIRCLE

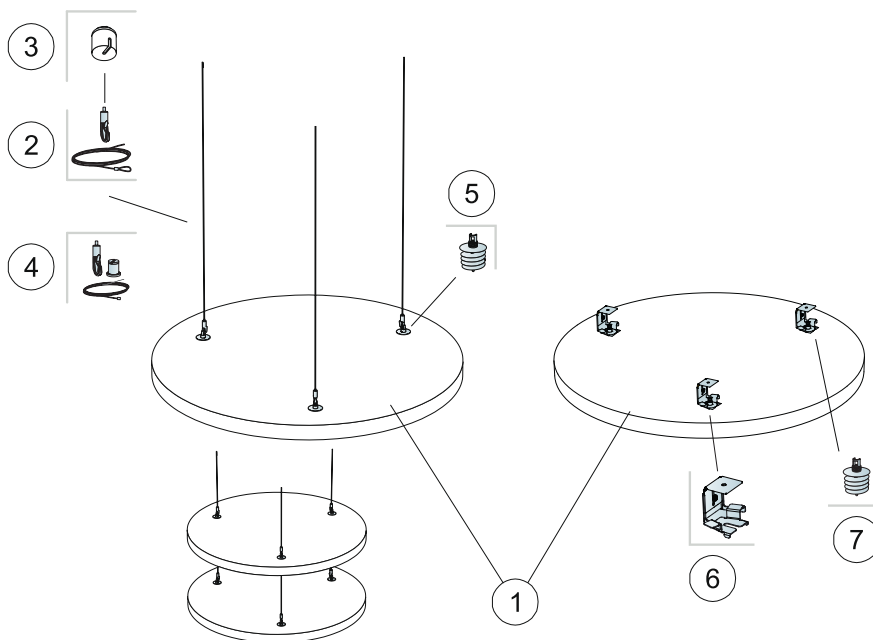

© Saint-Gobain Ecophon AB

### QUANTITY SPECIFICATION (EXCL. WASTAGE)

		Size, mm
		Ø800
1	Solo Circle	0,5m <sup>2</sup> /panel
2	Connect Adjustable wire hanger (Alt 1)	3/panel
3	Connect Covering cup (Alt 1, Optional)	3/panel
4	Connect Adjustable wire Kit (Alt 1, Optional)	3/panel
5	Connect Absorber anchor (Alt 1)	3/panel
6	Connect Absorber bracket (Alt 2)	3/panel
7	Connect Absorber anchor (Alt 2)	3/panel
Δ Min. overall depth of system: Δ1 140 mm / Δ2 90 mm		-

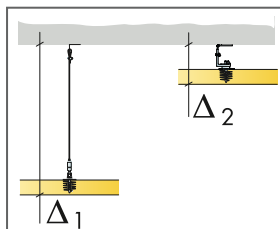

See Quantity specification

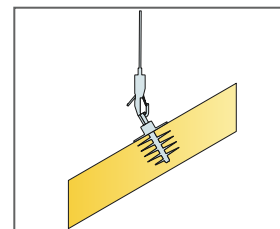
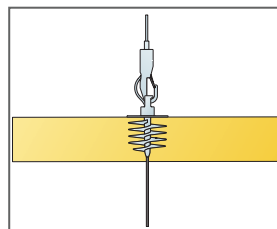
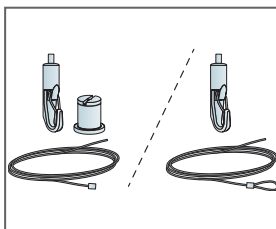

# Ecophon Solo™ Circle XL

Solo Circle XL is a large free hanging unit with two semicircles, offering a high degree of design possibilities. For applications when it is not possible to install a wall-to-wall ceiling



YOO Communications AG, St. Gallen, Switzerland

## SYSTEM RANGE



Size, mm	XL Ø1600
Special Fixing	•
Thickness (THK)	40
Inst. Diagr.	M290

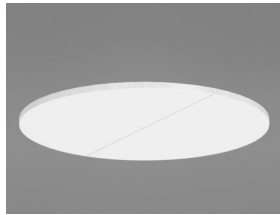

Solo Circle XL

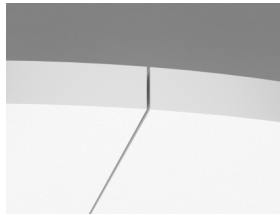

Solo Circle XL panel

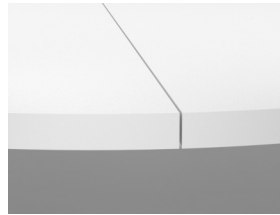

Rear side of Solo Circle XL

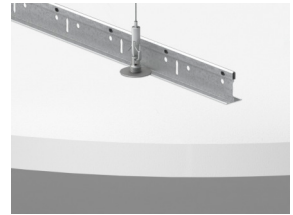

Solo Circle XL installation with Connect Absorber anchor

## Acoustic



The values in the diagram refer to a single unit. If the units are arranged in a cluster with distances between units less than 0,5 meters, the Aeq per unit will be slightly reduced.

### Sound Absorption:

Test results according to EN ISO 354.

A<sub>eq</sub>: Equivalent absorption area per unit (m<sup>2</sup> sabin)

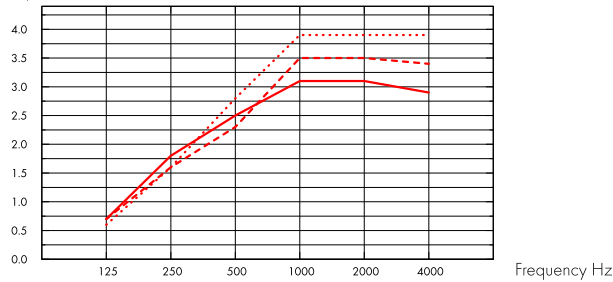

- Solo Circle XL, 200 mm o.d.s.
  - - - Solo Circle XL, 400 mm o.d.s.
  - ... Solo Circle XL, 1000 mm o.d.s.
- o.d.s. = overall depth of system

THK mm	o.d.s. mm	A <sub>eq</sub> : Equivalent absorption area per unit (m <sup>2</sup> sabin)					
		125 Hz	250 Hz	500 Hz	1000 Hz	2000 Hz	4000 Hz
40	200	0.7	1.8	2.5	3.1	3.1	2.9
40	400	0.7	1.6	2.3	3.5	3.5	3.4
40	1000	0.6	1.6	2.8	3.9	3.9	3.9

## Indoor Air Quality



Certificate / Label

Eurofins Indoor Air Comfort®

IAC Gold

French VOC

A+



## Cradle to Cradle Certified®



This product is Cradle to Cradle Certified® at Bronze level (version 4.0).



## Material Health



This product has received a C2C Certified Material Health Certificate™ at the Silver level (standard version 4.0).

The C2C Certified Material Health Certificate™ is a verification of the health and safety of a product's composition using the Material Health requirements of the Cradle-to-Cradle Certified Product Standard.

## Carbon footprint



kg CO<sub>2</sub> equiv/m<sup>2</sup>

Solo Circle

10,35

Life-cycle stages A1 to C4 from EPD, in conformity with ISO 14025 / EN 15804



### Circularity

Minimum post-consumer recycled content	57%
Recyclability	Fully recyclable



### Fire safety

Country	Fire standard	Class
Europe	EN 13501-1	A2-s1,d0

The glass wool core of the tiles is tested and classified as non-combustible according to EN ISO 1182.



### Humidity Resistance

Class C, relative humidity 95% and 30°C, according to EN 13964:2014



### Visual appearance

White Frost, nearest NCS colour sample S 0500-N, 85% light reflectance. Gloss < 1.



### Cleanability

Daily dusting and vacuum cleaning. Weekly wet wiping.



### Accessibility

The tiles are demountable.



### Installation

Installed according to installation diagrams, installation guides and drawing aid. For information regarding minimum overall depth of system see quantity specification.



### System weight

	kg/m <sup>2</sup>
Solo Circle XL	4,8

Weight information is indicative and subject to variation.



### Mechanical properties

No additional live load is allowed.



### CE

Ecophon ceiling systems are CE marked according to the European harmonized standard EN 13964:2014. CE marked construction products are covered by a Declaration of Performance (DOP) which enables customers and users to easily compare performance of products available on the European market.



## INSTALLATION DIAGRAM (M290) FOR ECOPHON SOLO CIRCLE XL

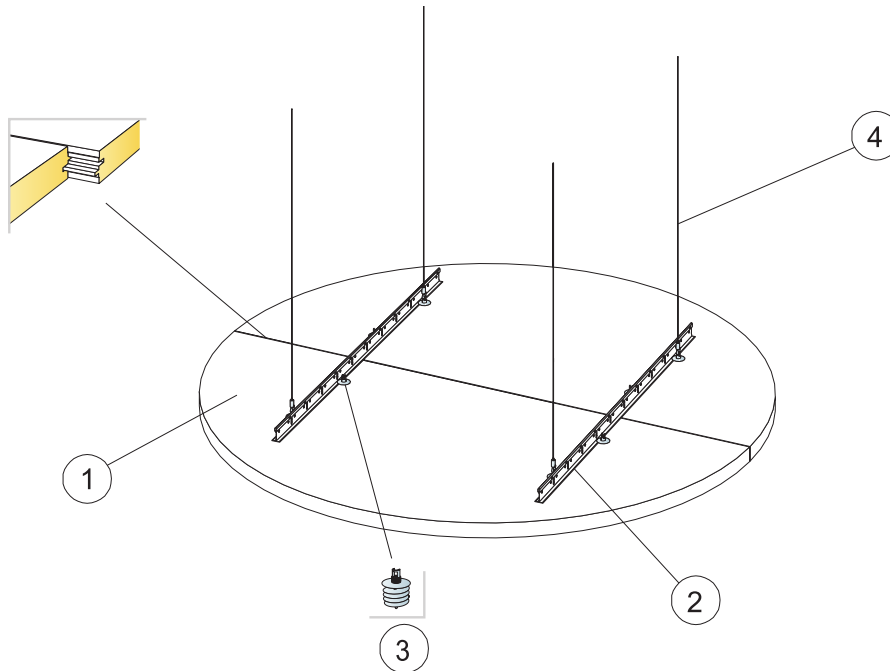

© Saint-Gobain Ecophon AB

### QUANTITY SPECIFICATION (EXCL. WASTAGE)

		Size, mm
		Ø1600
1	Solo Circle XL	2,01 m <sup>2</sup> /panel
2	Connect T24 Main runner	0,60/panel
3	Connect Absorber anchor	8/panel
4	Connect Adjustable wire hanger	4/panel
Δ Min. overall depth of system: Δ 200 mm		-
To install Connect Absorber Anchor, use Connect Absorber Anchor Bit.		-

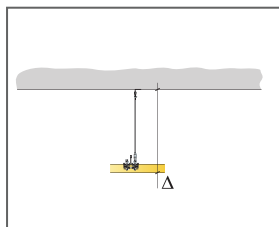

See Quantity specification

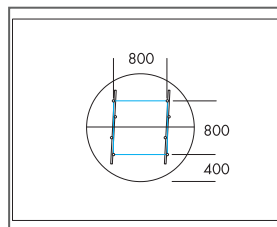

Suspension with Connect Adjustable wire hangers and Connect T24 Main runner

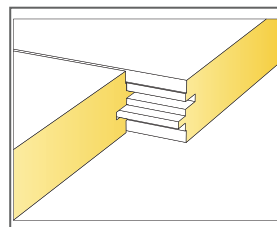

Meeting between panels

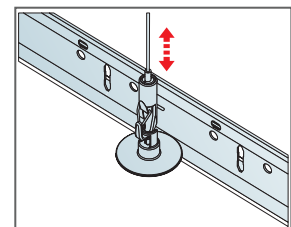

Easily adjustable suspension with Connect Adjustable wire hanger

# Ecophon Solo™ Cloud

Solo Cloud is a free-hanging unit, offering high level design possibilities. Three different suspension systems offer opportunities to create several layers and angles. Suitable when the room volume should be maintained or when it's not possible to install a wall-to-wall ceiling.



Chelamco Arena, Belgium

## SYSTEM RANGE



Size, mm	1200x553	2400x1106
Special Fixing	•	•
Thickness (THK)	40	40
Inst. Diagr.	M430	M430

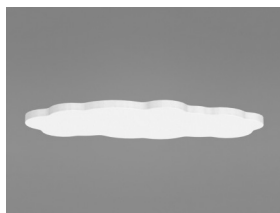

Solo Freedom



Suspension with Connect Adjustable wire hanger and Connect Absorber anchor

### Acoustic



For acoustic data on the panel - please see Solo Square and Rectangle.



### Cradle to Cradle Certified®



This product is Cradle to Cradle Certified® at Bronze level (version 4.0).



### Material Health



This product has received a C2C Certified Material Health Certificate™ at the Silver level (standard version 4.0). The C2C Certified Material Health Certificate™ is a verification of the health and safety of a product's composition using the Material Health requirements of the Cradle-to-Cradle Certified Product Standard.



### Carbon footprint

	kg CO <sub>2</sub> equiv/m <sup>2</sup>
Solo Freedom	8,41 (Solo Family EPD in conformity with ISO 14025 / EN 15804)

Life-cycle stages A1 to C4 from EPD, in conformity with ISO 14025 / EN 15804



### Circularity

Minimum post-consumer recycled content	57%
Recyclability	Fully recyclable



### Fire safety

Country	Fire standard	Class
Europe	EN 13501-1	A2-s1,d0

The glass wool core of the tiles is tested and classified as non-combustible according to EN ISO 1182.



### Humidity Resistance

Class C, relative humidity 95% and 30°C, according to EN 13964:2014



### Visual appearance

White Frost, nearest NCS colour sample S 0500-N, 85% light reflectance. Gloss < 1.



### Cleanability

Daily dusting and vacuum cleaning. Weekly wet wiping.



### **Accessibility**

---

The tiles are demountable.



### **Installation**

---

Installed according to installation diagrams, installation guides and drawing aid. For information regarding minimum overall depth of system see quantity specification.



### **Mechanical properties**

---

The tile can take both point loads and distributed loads. See Functional demands, Mechanical properties at [www.ecophon.com](http://www.ecophon.com).



### **CE**

---

Ecophon ceiling systems are CE marked according to the European harmonized standard EN 13964:2014. CE marked construction products are covered by a Declaration of Performance (DOP) which enables customers and users to easily compare performance of products available on the European market.

## INSTALLATION DIAGRAM (M412) FOR ECOPHON SOLO FREEDOM

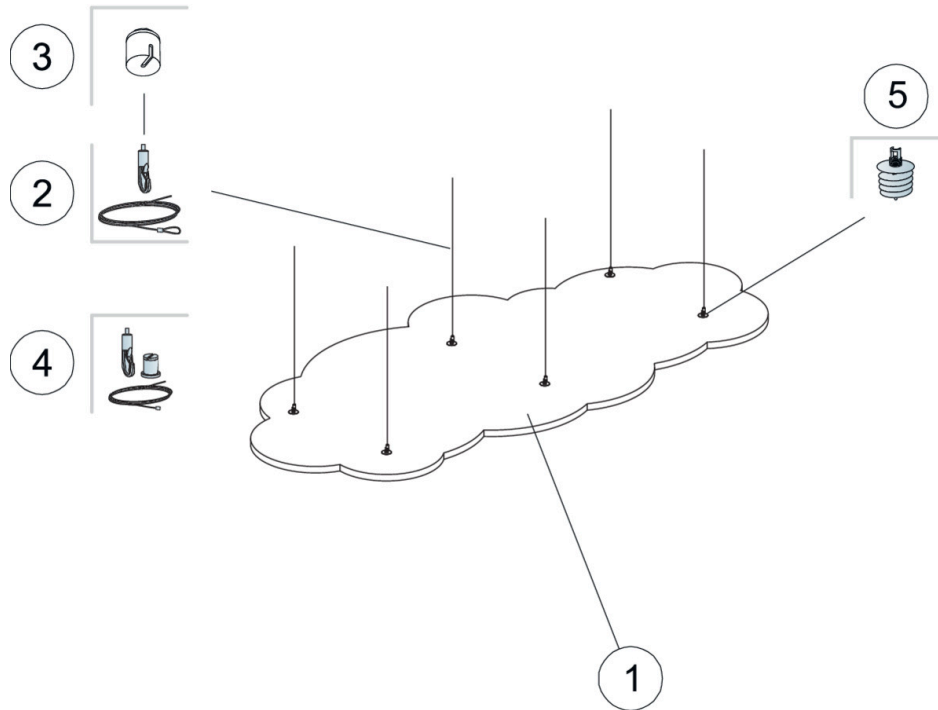

### QUANTITY SPECIFICATION (EXCL. WASTAGE)

		Size, mm	
		1200x553	2400x1106
1	Solo Freedom	-	-
2	Connect Adjustable wire hanger (Alt 1)	-	-
3	Connect Covering cup (Alt 1, Optional)	-	-
4	Connect Adjustable wire kit (Optional)	-	-
5	Connect Absorber anchor	-	-
Δ Min. overall depth of system: 140 mm		-	-

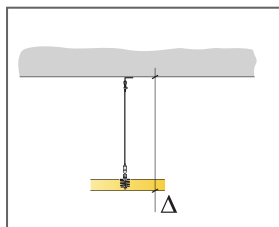

See Quantity specification

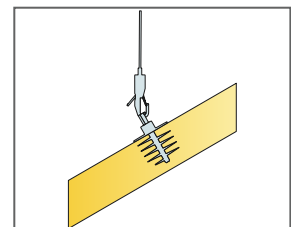
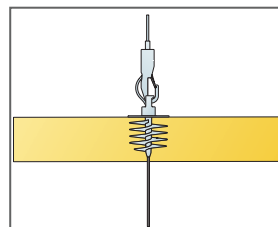
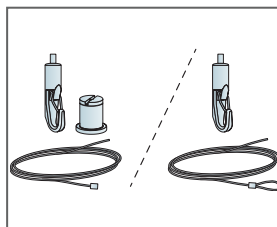

# Ecophon Solo™ Ellipse

Solo Ellipse is a free-hanging unit, offering high level design possibilities. Three different suspension systems offer opportunities to create several layers and angles. Suitable when the room volume should be maintained or when it's not possible to install a wall-to-wall ceiling.



Chelamco Arena, Belgium

## SYSTEM RANGE



Size, mm	2400x1000
Special Fixing	•
Thickness (THK)	40
Inst. Diagr.	M428

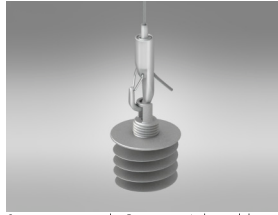
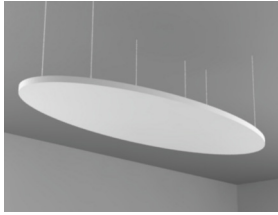

Suspension with Connect Adjustable wire hanger and Connect Absorber anchor

## Acoustic



The values in the diagram refer to a single unit. If the units are arranged in a cluster with distances between units less than 0,5 meters, the Aeq per unit will be slightly reduced.

### Sound Absorption:

Based on test results according to EN ISO 354.

A<sub>eq</sub>: Equivalent absorption area per unit (m<sup>2</sup> sabin)

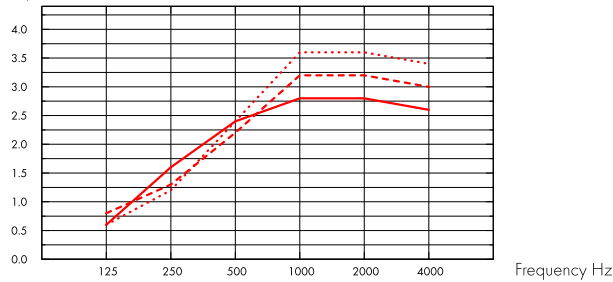

- Solo Ellipse 2400x1000, 200 mm o.d.s.
  - - - Solo Ellipse 2400x1000, 400 mm o.d.s.
  - ... Solo Ellipse 2400x1000, 1000 mm o.d.s.
- o.d.s. = overall depth of system

THK mm	o.d.s. mm	A <sub>eq</sub> : Equivalent absorption area per unit (m <sup>2</sup> sabin)					
		125 Hz	250 Hz	500 Hz	1000 Hz	2000 Hz	4000 Hz
40	200	0.6	1.6	2.4	2.8	2.8	2.6
40	400	0.8	1.3	2.2	3.2	3.2	3.0
40	1000	0.6	1.2	2.4	3.6	3.6	3.4

## Indoor Air Quality



Certificate / Label

Eurofins Indoor Air Comfort®

IAC Gold

French VOC

A+



## Cradle to Cradle Certified®



This product is Cradle to Cradle Certified® at Bronze level (version 4.0).



## Material Health



This product has received a C2C Certified Material Health Certificate™ at the Silver level (standard version 4.0). The C2C Certified Material Health Certificate™ is a verification of the health and safety of a product's composition using the Material Health requirements of the Cradle-to-Cradle Certified Product Standard.



## Carbon footprint

kg CO <sub>2</sub> equiv/m <sup>2</sup>		Life-cycle stages A1 to C4 from EPD, in conformity with ISO 14025 / EN 15804
Solo Freedom	8,41 (Solo Family EPD in conformity with ISO 14025 / EN 15804)	



## Circularity

Minimum post-consumer recycled content	57%
Recyclability	Fully recyclable



## Fire safety

Country	Fire standard	Class	The glass wool core of the tiles is tested and classified as non-combustible according to EN ISO 1182.
Europe	EN 13501-1	A2-s1,d0	



## Humidity Resistance

Class C, relative humidity 95% and 30°C, according to EN 13964:2014



## Visual appearance

White Frost, nearest NCS colour sample S 0500-N, 85% light reflectance. Gloss < 1.



## Cleanability

Daily dusting and vacuum cleaning. Weekly wet wiping.



## Accessibility

The tiles are demountable.



## Installation

Installed according to installation diagrams, installation guides and drawing aid. For information regarding minimum overall depth of system see quantity specification.



## System weight

kg/m <sup>2</sup>		Weight information is indicative and subject to variation.
Solo Ellipse	4,8	



## Mechanical properties

The tile can take both point loads and distributed loads. See Functional demands, Mechanical properties at [www.ecophon.com](http://www.ecophon.com).



## CE

Ecophon ceiling systems are CE marked according to the European harmonized standard EN 13964:2014. CE marked construction products are covered by a Declaration of Performance (DOP) which enables customers and users to easily compare performance of products available on the European market.



## INSTALLATION DIAGRAM (M428) FOR ECOPHON SOLO ELLIPSE

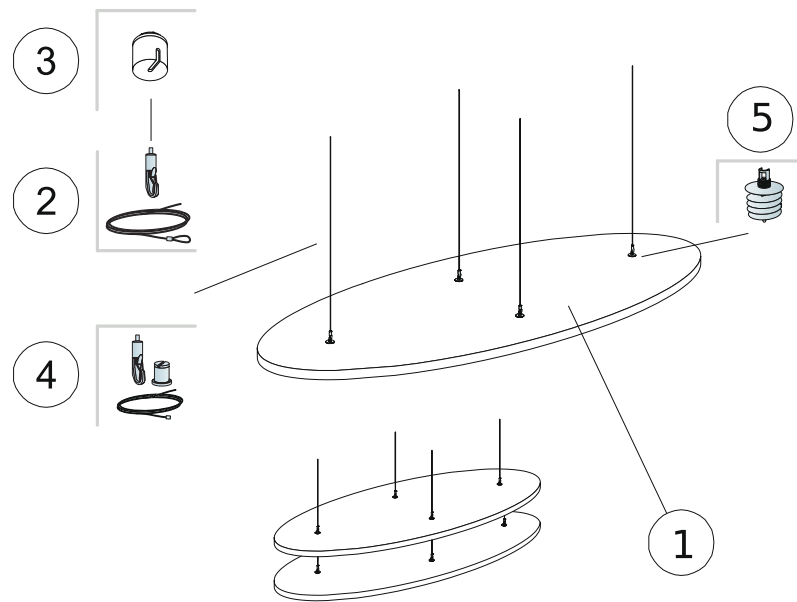

### QUANTITY SPECIFICATION (EXCL. WASTAGE)

		Size, mm
		<b>2400x1000</b>
1	Solo Ellipse	1,89m <sup>2</sup> /panel
2	Connect Adjustable wire hanger (Alt 1)	4/panel
3	Connect Covering cup (Alt 1, Optional)	4/panel
4	Connect Adjustable wire kit (Alt 1, Optional)	4/panel
5	Connect Absorber anchor (Alt 1)	4/panel
Δ Min. overall depth of system: 140 mm		-
To install Connect Absorber Anchor, use Connect Absorber Anchor Bit.		-

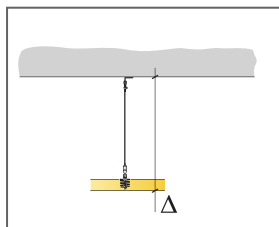

See Quantity specification

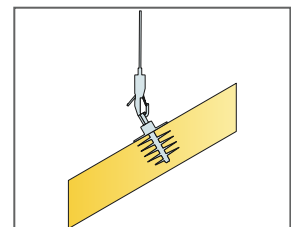
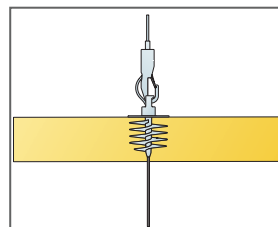
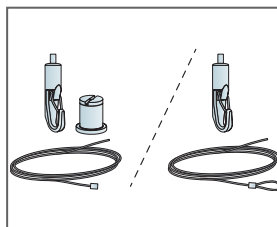

# Ecophon Solo™ Triangle

Solo Triangle is a free-hanging unit, offering high level design possibilities. Three different suspension systems offer opportunities to create several layers and angles. Suitable when the room volume should be maintained or when it's not possible to install a wall-to-wall ceiling.



Ghelamco Arena, Belgium

## SYSTEM RANGE



Size, mm	1039x1200
Special Fixing	•
Thickness (THK)	40
Inst. Diag.	M297

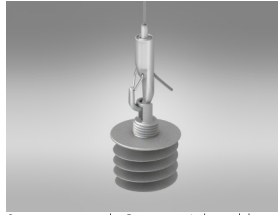
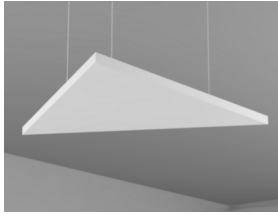

Suspension with Connect Adjustable wire hanger and Connect Absorber anchor

## Acoustic



The values in the diagram refer to a single unit. If the units are arranged in a cluster with distances between units less than 0,5 meters, the Aeq per unit will be slightly reduced.

### Sound Absorption:

Based on test results according to EN ISO 354.

A<sub>eq</sub>: Equivalent absorption area per unit (m<sup>2</sup> sabin)

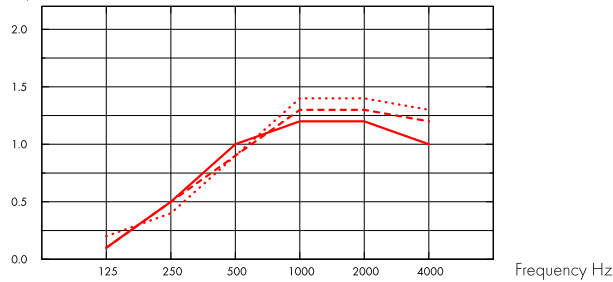

- Solo Triangle 1039x1200, 200 mm o.d.s.
  - - - Solo Triangle 1039x1200, 400 mm o.d.s.
  - ... Solo Triangle 1039x1200, 1000 mm o.d.s.
- o.d.s = overall depth of system

THK mm	o.d.s. mm	A <sub>eq</sub> : Equivalent absorption area per unit (m <sup>2</sup> sabin)					
		125 Hz	250 Hz	500 Hz	1000 Hz	2000 Hz	4000 Hz
40	200	0.1	0.5	1.0	1.2	1.2	1.0
40	400	0.1	0.5	0.9	1.3	1.3	1.2
40	1000	0.2	0.4	0.9	1.4	1.4	1.3

## Indoor Air Quality



Certificate / Label

Eurofins Indoor Air Comfort®

IAC Gold

French VOC

A+



## Cradle to Cradle Certified®



This product is Cradle to Cradle Certified® at Bronze level (version 4.0).



## Material Health



This product has received a C2C Certified Material Health Certificate™ at the Silver level (standard version 4.0). The C2C Certified Material Health Certificate™ is a verification of the health and safety of a product's composition using the Material Health requirements of the Cradle-to-Cradle Certified Product Standard.



## Carbon footprint

kg CO <sub>2</sub> equiv/m <sup>2</sup>		Life-cycle stages A1 to C4 from EPD, in conformity with ISO 14025 / EN 15804
Solo Freedom	8,41 (Solo Family EPD in conformity with ISO 14025 / EN 15804)	



## Circularity

Minimum post-consumer recycled content	57%
Recyclability	Fully recyclable



## Fire safety

Country	Fire standard	Class	The glass wool core of the tiles is tested and classified as non-combustible according to EN ISO 1182.
Europe	EN 13501-1	A2-s1,d0	



## Humidity Resistance

Class C, relative humidity 95% and 30°C, according to EN 13964:2014



## Visual appearance

White Frost, nearest NCS colour sample S 0500-N, 85% light reflectance. Gloss < 1.



## Cleanability

Daily dusting and vacuum cleaning. Weekly wet wiping.



## Accessibility

The tiles are demountable.



## Installation

Installed according to installation diagrams, installation guides and drawing aid. For information regarding minimum overall depth of system see quantity specification.



## System weight

kg/m <sup>2</sup>		Weight information is indicative and subject to variation.
Solo Triangle	4,7	



## Mechanical properties

The tile can take both point loads and distributed loads. See Functional demands, Mechanical properties at [www.ecophon.com](http://www.ecophon.com).



## CE

Ecophon ceiling systems are CE marked according to the European harmonized standard EN 13964:2014. CE marked construction products are covered by a Declaration of Performance (DOP) which enables customers and users to easily compare performance of products available on the European market.

## INSTALLATION DIAGRAM (M297) FOR ECOPHON SOLO TRIANGLE

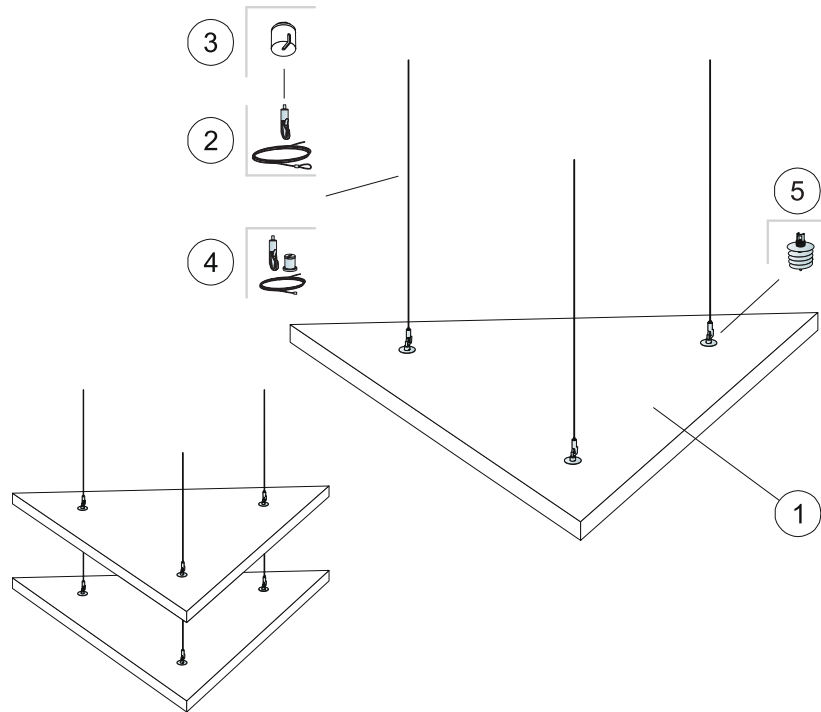

### QUANTITY SPECIFICATION (EXCL. WASTAGE)

		Size, mm
		1039x1200
1	Solo Triangle	0,62m <sup>2</sup> /panel
2	Connect Adjustable wire hanger	3/panel
3	Connect Covering cup (Optional)	3/panel
4	Connect Adjustable wire Kit (Alt 1, Optional)	3/panel
5	Connect Absorber anchor	3/panel
Δ Min. overall depth of system: 140 mm		-
To install Connect Absorber Anchor, use Connect Absorber Anchor Bit.		-

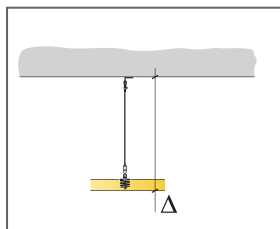

See Quantity specification

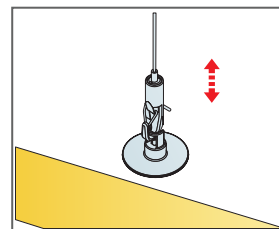
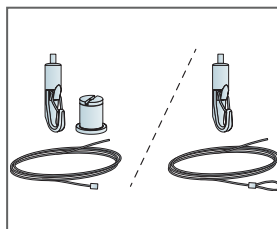

Easily adjustable suspension with Connect Adjustable wire hanger

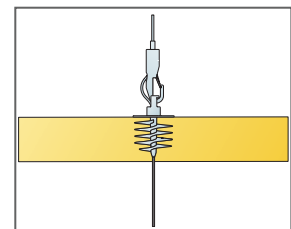

# Ecophon Solo™ Pentagon

Solo Pentagon is a free-hanging unit, offering high level design possibilities. Three different suspension systems offer opportunities to create several layers and angles. Suitable when the room volume should be maintained or when it's not possible to install a wall-to-wall ceiling.



Ghelamco Arena, Belgium

## SYSTEM RANGE



Size, mm	1139x1198
Special Fixing	•
Thickness (THK)	40
Inst. Diagr.	M427

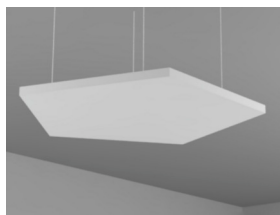

Solo Freedom



Suspension with Connect Adjustable wire hanger and Connect Absorber anchor

## Acoustic



The values in the diagram refer to a single unit. If the units are arranged in a cluster with distances between units less than 0,5 meters, the Aeq per unit will be slightly reduced.

### Sound Absorption:

Based on test results according to EN ISO 354.

A<sub>eq</sub>: Equivalent absorption area per unit (m<sup>2</sup> sabin)

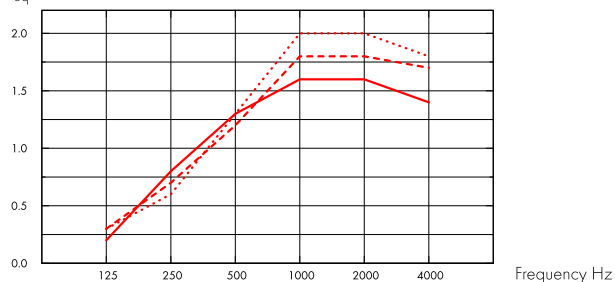

- Solo Pentagon 1139x1198, 200 mm o.d.s.
  - - - Solo Pentagon 1139x1198, 400 mm o.d.s.
  - ... Solo Pentagon 1139x1198, 1000 mm o.d.s.
- o.d.s. = overall depth of system

THK mm	o.d.s. mm	A <sub>eq</sub> : Equivalent absorption area per unit (m <sup>2</sup> sabin)					
		125 Hz	250 Hz	500 Hz	1000 Hz	2000 Hz	4000 Hz
40	200	0.2	0.8	1.3	1.6	1.6	1.4
40	400	0.3	0.7	1.2	1.8	1.8	1.7
40	1000	0.3	0.6	1.3	2.0	2.0	1.8

## Indoor Air Quality



Certificate / Label

Eurofins Indoor Air Comfort®

IAC Gold

French VOC

A+



## Cradle to Cradle Certified®



This product is Cradle to Cradle Certified® at Bronze level (version 4.0).



## Material Health



This product has received a C2C Certified Material Health Certificate™ at the Silver level (standard version 4.0). The C2C Certified Material Health Certificate™ is a verification of the health and safety of a product's composition using the Material Health requirements of the Cradle-to-Cradle Certified Product Standard.



## Carbon footprint

kg CO <sub>2</sub> equiv/m <sup>2</sup>		Life-cycle stages A1 to C4 from EPD, in conformity with ISO 14025 / EN 15804
Solo Freedom	8,41 (Solo Family EPD in conformity with ISO 14025 / EN 15804)	



## Circularity

Minimum post-consumer recycled content	57%
Recyclability	Fully recyclable



## Fire safety

Country	Fire standard	Class	The glass wool core of the tiles is tested and classified as non-combustible according to EN ISO 1182.
Europe	EN 13501-1	A2-s1,d0	



## Humidity Resistance

Class C, relative humidity 95% and 30°C, according to EN 13964:2014



## Visual appearance

White Frost, nearest NCS colour sample S 0500-N, 85% light reflectance. Gloss < 1.



## Cleanability

Daily dusting and vacuum cleaning. Weekly wet wiping.



## Accessibility

The tiles are demountable.



## Installation

Installed according to installation diagrams, installation guides and drawing aid. For information regarding minimum overall depth of system see quantity specification.



## System weight

kg/m <sup>2</sup>		Weight information is indicative and subject to variation.
Solo Pentagon	4,7	



## Mechanical properties

The tile can take both point loads and distributed loads. See Functional demands, Mechanical properties at [www.ecophon.com](http://www.ecophon.com).



## CE

Ecophon ceiling systems are CE marked according to the European harmonized standard EN 13964:2014. CE marked construction products are covered by a Declaration of Performance (DOP) which enables customers and users to easily compare performance of products available on the European market.



## INSTALLATION DIAGRAM (M427) FOR ECOPHON SOLO PENTAGON

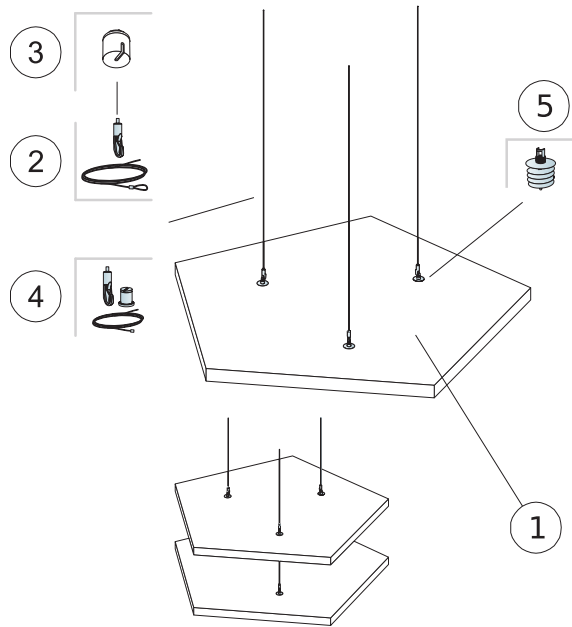

### QUANTITY SPECIFICATION (EXCL. WASTAGE)

		Size, mm
		1139x1198
1	Solo Pentagon	0,94m <sup>2</sup> /panel
2	Connect Adjustable wire hanger (Alt 1)	3/panel
3	Connect Covering cup (Alt 1, Optional)	3/panel
4	Connect Adjustable wire Kit (Alt 1, Optional)	3/panel
5	Connect Absorber anchor (Alt 1)	3/panel
Δ Min. overall depth of system: 140 mm		-
To install Connect Absorber Anchor, use Connect Absorber Anchor Bit.		-

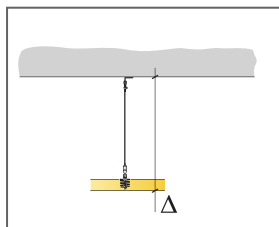

See Quantity specification

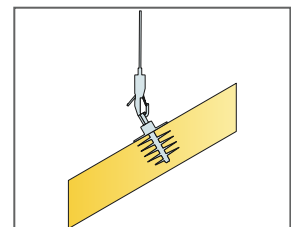
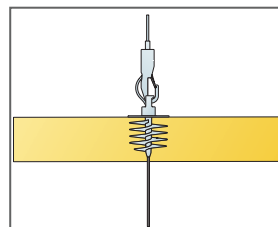
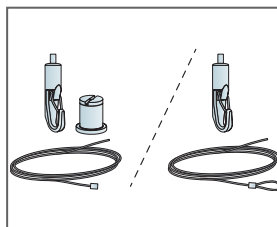

# Ecophon Solo™ Hexagon

Solo Hexagon is a free-hanging unit, offering high level design possibilities. Three different suspension systems offer opportunities to create several layers and angles. Suitable when the room volume should be maintained or when it's not possible to install a wall-to-wall ceiling.



Chelancio Arena, Belgium

## SYSTEM RANGE



Size, mm	1040x1200
Special Fixing	•
Thickness (THK)	40
Inst. Diagr.	M426

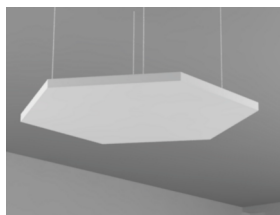

Suspension with Connect Adjustable wire hanger and Connect Absorber anchor

## Acoustic



The values in the diagram refer to a single unit. If the units are arranged in a cluster with distances between units less than 0,5 meters, the Aeq per unit will be slightly reduced.

### Sound Absorption:

Based on test results according to EN ISO 354.

A<sub>eq</sub>: Equivalent absorption area per unit (m<sup>2</sup> sabin)

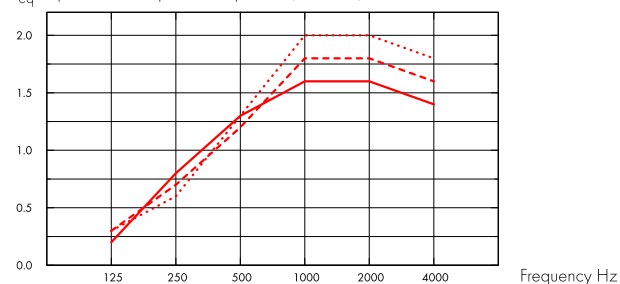

- Solo Hexagon 1040x1200, 200 mm o.d.s.
  - - - Solo Hexagon 1040x1200, 400 mm o.d.s.
  - ... Solo Hexagon 1040x1200, 1000 mm o.d.s.
- o.d.s = overall depth of system

THK mm	o.d.s. mm	A <sub>eq</sub> : Equivalent absorption area per unit (m <sup>2</sup> sabin)					
		125 Hz	250 Hz	500 Hz	1000 Hz	2000 Hz	4000 Hz
40	200	0.2	0.8	1.3	1.6	1.6	1.4
40	400	0.3	0.7	1.2	1.8	1.8	1.6
40	1000	0.3	0.6	1.3	2.0	2.0	1.8

## Indoor Air Quality



Certificate / Label

Eurofins Indoor Air Comfort®

IAC Gold

French VOC

A+



## Cradle to Cradle Certified®



This product is Cradle to Cradle Certified® at Bronze level (version 4.0).



## Material Health



This product has received a C2C Certified Material Health Certificate™ at the Silver level (standard version 4.0). The C2C Certified Material Health Certificate™ is a verification of the health and safety of a product's composition using the Material Health requirements of the Cradle-to-Cradle Certified Product Standard.



## Carbon footprint

kg CO <sub>2</sub> equiv/m <sup>2</sup>		Life-cycle stages A1 to C4 from EPD, in conformity with ISO 14025 / EN 15804
Solo Freedom	8,41 (Solo Family EPD in conformity with ISO 14025 / EN 15804)	



## Circularity

Minimum post-consumer recycled content	57%
Recyclability	Fully recyclable



## Fire safety

Country	Fire standard	Class	The glass wool core of the tiles is tested and classified as non-combustible according to EN ISO 1182.
Europe	EN 13501-1	A2-s1,d0	



## Humidity Resistance

Class C, relative humidity 95% and 30°C, according to EN 13964:2014



## Visual appearance

White Frost, nearest NCS colour sample S 0500-N, 85% light reflectance. Gloss < 1.



## Cleanability

Daily dusting and vacuum cleaning. Weekly wet wiping.



## Accessibility

The tiles are demountable.



## Installation

Installed according to installation diagrams, installation guides and drawing aid. For information regarding minimum overall depth of system see quantity specification.



## System weight

kg/m <sup>2</sup>		Weight information is indicative and subject to variation.
Solo Hexagon	4,7	



## Mechanical properties

The tile can take both point loads and distributed loads. See Functional demands, Mechanical properties at [www.ecophon.com](http://www.ecophon.com).



## CE

Ecophon ceiling systems are CE marked according to the European harmonized standard EN 13964:2014. CE marked construction products are covered by a Declaration of Performance (DOP) which enables customers and users to easily compare performance of products available on the European market.

## INSTALLATION DIAGRAM (M426) FOR ECOPHON SOLO HEXAGON

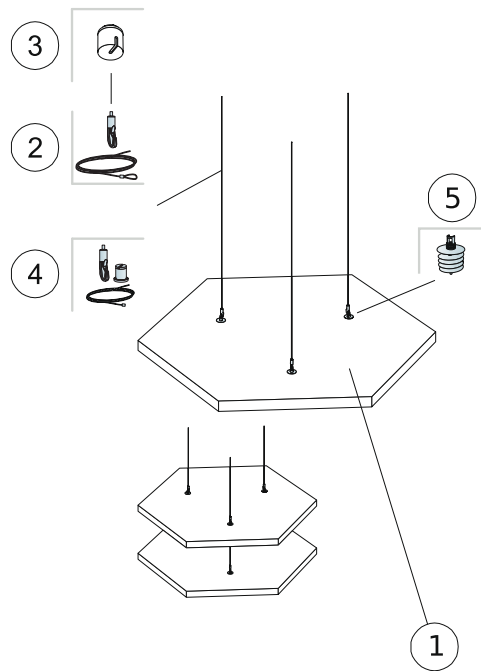

### QUANTITY SPECIFICATION (EXCL. WASTAGE)

		Size, mm
		1040x1200
1	Solo Hexagon	0,94m <sup>2</sup> /panel
2	Connect Adjustable wire hanger (Alt 1)	3/panel
3	Connect Covering cup (Alt 1, Optional)	3/panel
4	Connect Adjustable wire Kit (Alt 1, Optional)	3/panel
5	Connect Absorber anchor (Alt 1)	3/panel
Δ Min. overall depth of system: 140 mm		-
To install Connect Absorber Anchor, use Connect Absorber Anchor Bit.		-

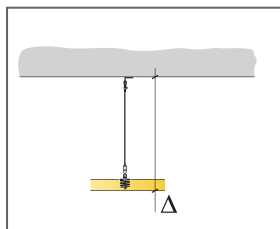

See Quantity specification

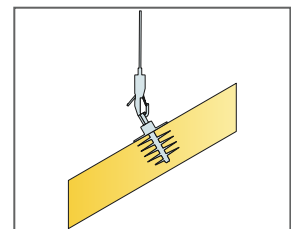
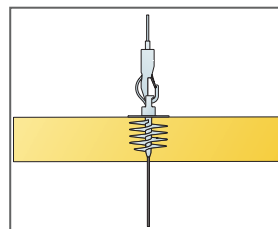
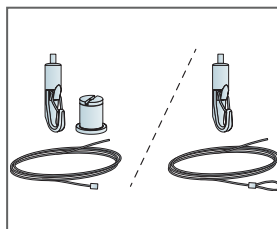

# Ecophon Solo™ Baffle

Solo Baffle is vertically installed unframed baffles. Solo Baffle can be used to form distinct lines and is available in different sizes and a wide range of colours. Baffles are used primarily when natural light is brought into the room via skylight.



Plantorics, Hoofddorp, Netherlands

## SYSTEM RANGE

Size, mm	1200x200	1200x300	1200x600	1800x200	1800x300	1800x600
Special Fixing	•	•	•	•	•	•
Thickness (THK)	40	40	40	40	40	40
Inst. Diagr.	M414, M491, M563, M580	M414, M491, M563, M580	M414, M491, M563, M580	M414, M491, M563, M580	M414, M491, M563, M580	M414, M491, M563, M580

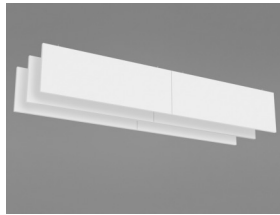

Solo Baffle

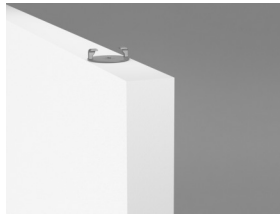

Solo Baffle/anchor



Solo Baffle/anchor installation

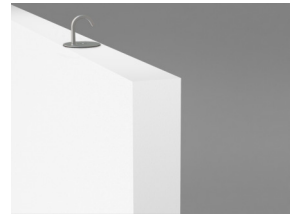

Solo Baffle/hook

## Acoustic



### Sound Absorption:

Test results according to EN ISO 354:2003 NOTE: Results shown are not comparable with results according to older versions of this standard due to discrepancies in test method. Classification according to EN ISO 11654, and the single value ratings for Noise Reduction Coefficient, NRC and Sound Absorption Average, SAA according to ASTM C 423.

$\alpha_p$ , Practical sound absorption coefficient

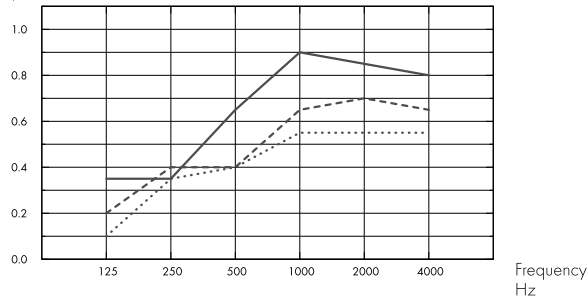

.... Solo Baffle 1200/1800x200, spacing 600mm, direct mounting

--- Solo Baffle 1200/1800x300, spacing 600mm, direct mounting

- Solo Baffle 1200/1800x600, spacing 600mm, direct mounting

o.d.s = overall depth of system

$A_{eq}$ , Equivalent absorption area per unit ( $m^2$  sabin)

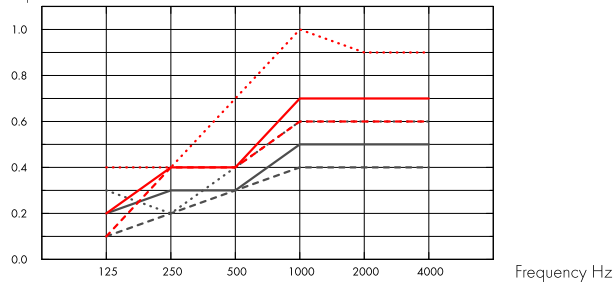

--- Solo Baffle 1200x200

- Solo Baffle 1200x300

.... Solo Baffle 1200x600

--- Solo Baffle 1800x200

- Solo Baffle 1800x300

.... Solo Baffle 1800x600

o.d.s = overall depth of system

	THK mm	o.d.s. mm	$\alpha_p$ , Practical sound absorption coefficient						$\alpha_w$
			125 Hz	250 Hz	500 Hz	1000 Hz	2000 Hz	4000 Hz	
c600	40	200	0.10	0.35	0.40	0.55	0.55	0.55	0.50
c600	40	300	0.20	0.40	0.40	0.65	0.70	0.65	0.50
c600	40	600	0.35	0.35	0.65	0.90	0.85	0.80	0.65

	THK mm	o.d.s. mm	$A_{eq}$ , Equivalent absorption area per unit ( $m^2$ sabin)					
			125 Hz	250 Hz	500 Hz	1000 Hz	2000 Hz	4000 Hz
1200x200 c600	40	200	0.1	0.2	0.3	0.4	0.4	0.4
1200x300 c600	40	300	0.2	0.3	0.3	0.5	0.5	0.5
1200x600 c600	40	600	0.3	0.2	0.4	0.6	0.6	0.6
1800x200 c600	40	200	0.1	0.4	0.4	0.6	0.6	0.6
1800x300 c600	40	300	0.2	0.4	0.4	0.7	0.7	0.7
1800x600 c600	40	600	0.4	0.4	0.7	1.0	0.9	0.9

	THK mm	o.d.s. mm	NRC	SAA
c200	40	200	0.65	0.65
c400	40	200	0.50	0.51
c600	40	200	0.45	0.43
c800	40	200	0.40	0.37
c200	40	300	0.70	0.71
c400	40	300	0.60	0.61
c600	40	300	0.55	0.53
c800	40	300	0.45	0.46
c200	40	600	0.80	0.82
c400	40	600	0.75	0.74
c600	40	600	0.70	0.67
c800	40	600	0.60	0.60



### Indoor Air Quality

Certificate / Label	
Eurofins Indoor Air Comfort®	IAC Gold
French VOC	A+



### Cradle to Cradle Certified®



This product is Cradle to Cradle Certified® at Bronze level (version 4.0).



### Material Health



This product has received a C2C Certified Material Health Certificate™ at the Silver level (standard version 4.0). The C2C Certified Material Health Certificate™ is a verification of the health and safety of a product's composition using the Material Health requirements of the Cradle-to-Cradle Certified Product Standard.



### Carbon footprint

	kg CO <sub>2</sub> equiv/m <sup>2</sup>	Life-cycle stages A1 to C4 from EPD, in conformity with ISO 14025 / EN 15804
Solo Baffle & Solo Baffle Wall	10,11	



### Circularity

Minimum post-consumer recycled content	57%
Recyclability	Fully recyclable



### Fire safety

Country	Fire standard	Class
Europe	EN 13501-1	A2-s1,d0

The glass wool core of the tiles is tested and classified as non-combustible according to EN ISO 1182.



### Humidity Resistance

Class C, relative humidity 95% and 30°C, according to EN 13964:2014





## Visual appearance

---

White Frost, nearest NCS colour sample S 0500-N, 85% light reflectance. Gloss < 1.



## Cleanability

---

Daily dusting and vacuum cleaning. Weekly wet wiping.



## Accessibility

---

The tiles are demountable.



## Installation

---

Installed according to installation diagrams, installation guides and drawing aid. For information regarding minimum overall depth of system see quantity specification.



## System weight

---

	kg/m <sup>2</sup>	Weight information is indicative and subject to variation.
Solo Baffle	4,6	



## Mechanical properties

---

Additional live load has to be fixed to the soffit.



## CE

---

Ecophon ceiling systems are CE marked according to the European harmonized standard EN 13964:2014. CE marked construction products are covered by a Declaration of Performance (DOP) which enables customers and users to easily compare performance of products available on the European market.

## INSTALLATION DIAGRAM (M414) FOR ECOPHON SOLO BAFFLE/ANCHOR

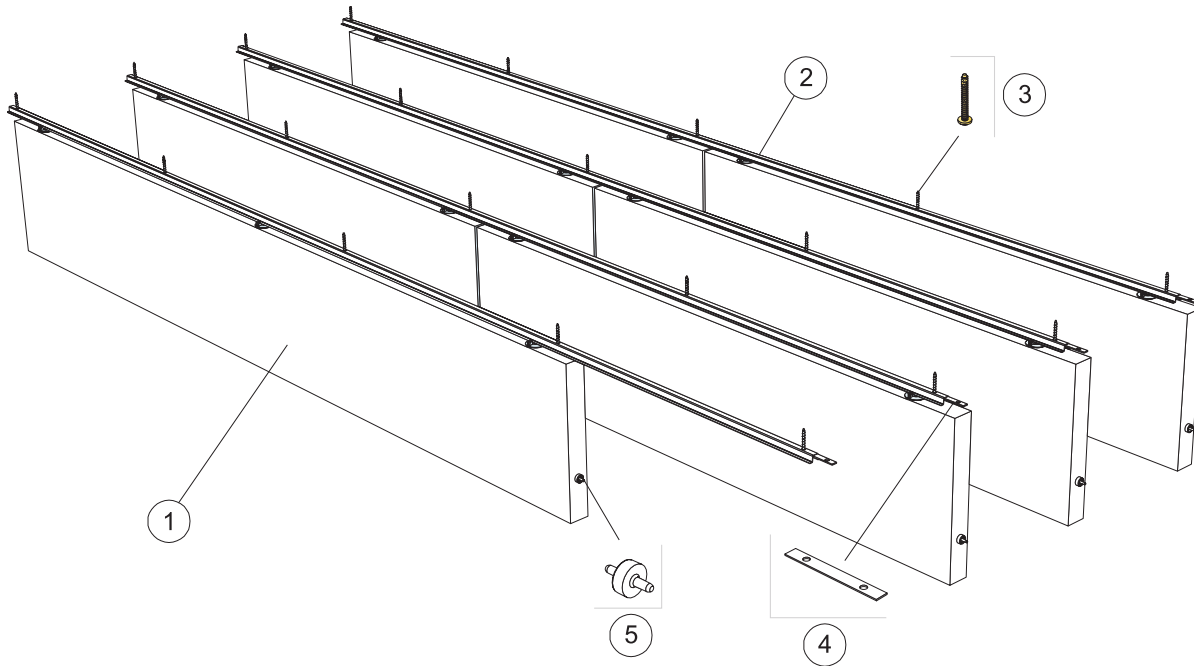

© Saint-Gobain Ecophon AB

### QUANTITY SPECIFICATION (EXCL. WASTAGE)

	Size, mm					
	1200x200	1200x300	1200x600	1800x200	1800x300	1800x600
1 Solo Baffle/anchor, installed at 300 mm centres	2,8/m <sup>2</sup>	2,8/m <sup>2</sup>	2,8/m <sup>2</sup>	1,9/m <sup>2</sup>	1,9/m <sup>2</sup>	1,9/m <sup>2</sup>
2 Connect Baffle profile, installed at 300 mm centres	3,3m/m <sup>2</sup>	3,3m/m <sup>2</sup>	3,3m/m <sup>2</sup>	3,3m/m <sup>2</sup>	3,3m/m <sup>2</sup>	3,3m/m <sup>2</sup>
3 Connect Anchor screw, fixed at 1200 mm centres	2,8/m <sup>2</sup>	2,8/m <sup>2</sup>	2,8/m <sup>2</sup>	2,8/m <sup>2</sup>	2,8/m <sup>2</sup>	2,8/m <sup>2</sup>
4 Connect Profile connector, installed at 2400 mm centres	1,4/m <sup>2</sup>	1,4/m <sup>2</sup>	1,4/m <sup>2</sup>	1,4/m <sup>2</sup>	1,4/m <sup>2</sup>	1,4/m <sup>2</sup>
5 Connect Guiding pin, installed at 1200/1800 mm centres	2,8/m <sup>2</sup>	2,8/m <sup>2</sup>	2,8/m <sup>2</sup>	1,9/m <sup>2</sup>	1,9/m <sup>2</sup>	1,9/m <sup>2</sup>

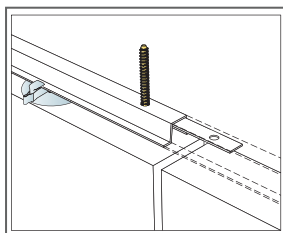

Fixing of Connect Profile connector

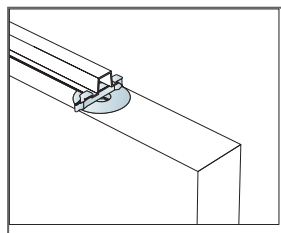

The baffles are secured with clips

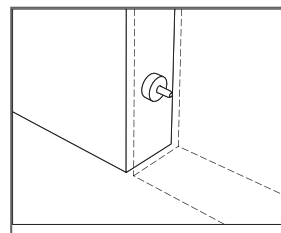

Connect Guiding pin, used to fix distance and level between panels

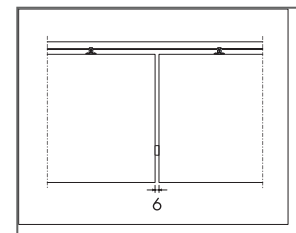

Distinct gap of 6 mm between baffles with Connect Guiding pin

## INSTALLATION DIAGRAM (M491) FOR ECOPHON SOLO BAFFLE/HOOK

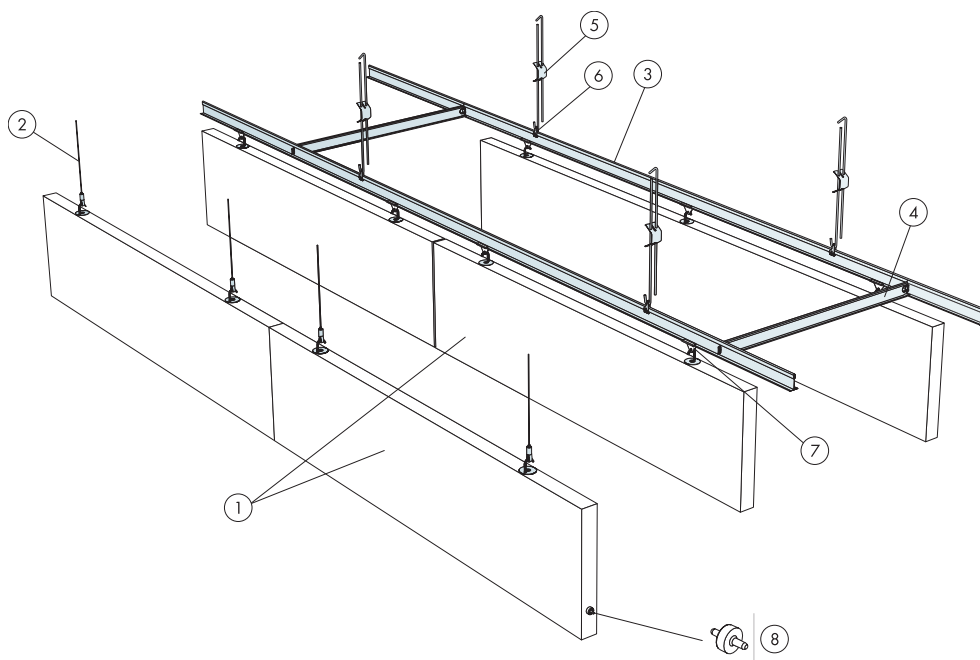

© Saint-Gobain Ecophon AB

### QUANTITY SPECIFICATION (EXCL. WASTAGE)

	Size, mm					
	1200x200	1200x300	1200x600	1800x200	1800x300	1800x600
1 Solo Baffle/hook, installed at 600 mm centres	1,4/m <sup>2</sup>	1,4/m <sup>2</sup>	1,4/m <sup>2</sup>	0,9/m <sup>2</sup>	0,9/m <sup>2</sup>	0,9/m <sup>2</sup>
2 Connect Adjustable wire hanger (Alt 1)	2/panel	2/panel	2/panel	3/panel	3/panel	3/panel
3 Connect T24 Main runner, installed at 600 mm centres (Alt 2)	1,7m/m <sup>2</sup>	1,7m/m <sup>2</sup>	1,7m/m <sup>2</sup>	1,7m/m <sup>2</sup>	1,7m/m <sup>2</sup>	1,7m/m <sup>2</sup>
4 Connect T24 Cross tee, L=600 mm, installed at 1800 mm centres (Alt 2)	0,6m/m <sup>2</sup>	0,6m/m <sup>2</sup>	0,6m/m <sup>2</sup>	0,6m/m <sup>2</sup>	0,6m/m <sup>2</sup>	0,6m/m <sup>2</sup>
5 Connect Adjustable hanger (Alt 2) c1200	1,4/m <sup>2</sup>	1,4/m <sup>2</sup>	1,4/m <sup>2</sup>	1,4/m <sup>2</sup>	1,4/m <sup>2</sup>	1,4/m <sup>2</sup>
6 Connect Hanger clip (Alt 2)	1,4/m <sup>2</sup>	1,4/m <sup>2</sup>	1,4/m <sup>2</sup>	1,4/m <sup>2</sup>	1,4/m <sup>2</sup>	1,4/m <sup>2</sup>
7 Connect Baffle clip (Alt 2)	2,8/m <sup>2</sup>	2,8/m <sup>2</sup>	2,8/m <sup>2</sup>	2,8/m <sup>2</sup>	2,8/m <sup>2</sup>	2,8/m <sup>2</sup>
8 Connect Guiding pin, installed at 1200/1800 mm centres	2,8/m <sup>2</sup>	2,8/m <sup>2</sup>	2,8/m <sup>2</sup>	0,9/m <sup>2</sup>	0,9/m <sup>2</sup>	0,9/m <sup>2</sup>

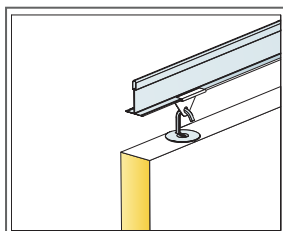

Detail of suspension

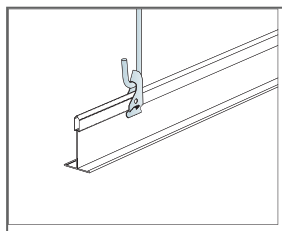

Suspension with adjustable hanger and clip

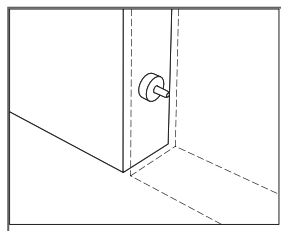

Connect Guiding pin, used to fix distance and level between panels

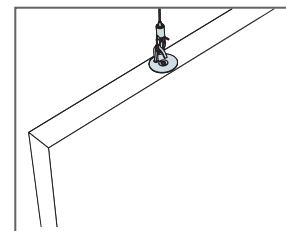

Suspension with Connect Adjustable wire hanger

## INSTALLATION DIAGRAM (M563) FOR ECOPHON SOLO BAFFLE/ANCHOR

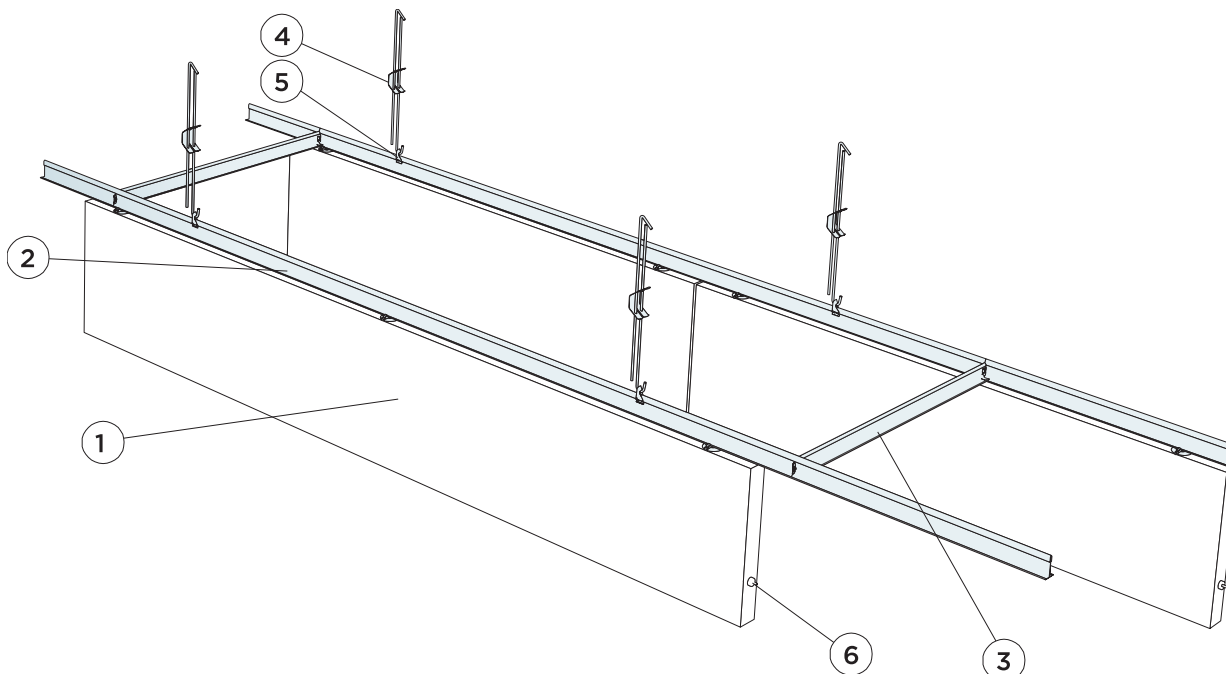

© Saint-Gobain Ecophon AB

### QUANTITY SPECIFICATION (EXCL. WASTAGE)

	Size, mm					
	1200x200	1200x300	1200x600	1800x200	1800x300	1800x600
1 Solo Baffle/anchor, installed at 600 mm centres	1,4/m <sup>2</sup>	1,4/m <sup>2</sup>	1,4/m <sup>2</sup>	0,9/m <sup>2</sup>	0,9/m <sup>2</sup>	0,9/m <sup>2</sup>
2 Connect T24 Main runner, installed at 600 mm centres [Alt 2]	1,7m/m <sup>2</sup>	1,7m/m <sup>2</sup>	1,7m/m <sup>2</sup>	1,7m/m <sup>2</sup>	1,7m/m <sup>2</sup>	1,7m/m <sup>2</sup>
3 Connect T24 Cross tee, L=600 mm, installed at 1800 mm centres [Alt 2]	0,6m/m <sup>2</sup>	0,6m/m <sup>2</sup>	0,6m/m <sup>2</sup>	0,6m/m <sup>2</sup>	0,6m/m <sup>2</sup>	0,6m/m <sup>2</sup>
4 Connect Adjustable hanger (Alt 2) c1200	1,4/m <sup>2</sup>	1,4/m <sup>2</sup>	1,4/m <sup>2</sup>	1,4/m <sup>2</sup>	1,4/m <sup>2</sup>	1,4/m <sup>2</sup>
5	-	-	0,7/m <sup>2</sup>	-	-	-
6 Connect Guiding pin, installed at 1200/1800 mm centres	2,8/m <sup>2</sup>	2,8/m <sup>2</sup>	2,8/m <sup>2</sup>	0,9/m <sup>2</sup>	0,9/m <sup>2</sup>	0,9/m <sup>2</sup>

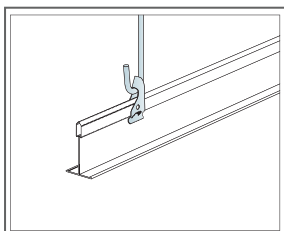

Suspension with adjustable hanger and clip

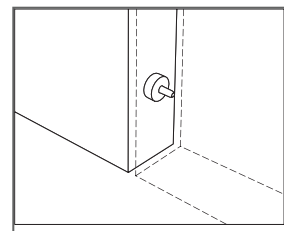

Connect Guiding pin, used to fix distance and level between panels

## INSTALLATION DIAGRAM (M563) FOR ECOPHON SOLO BAFFLE/ANCHOR

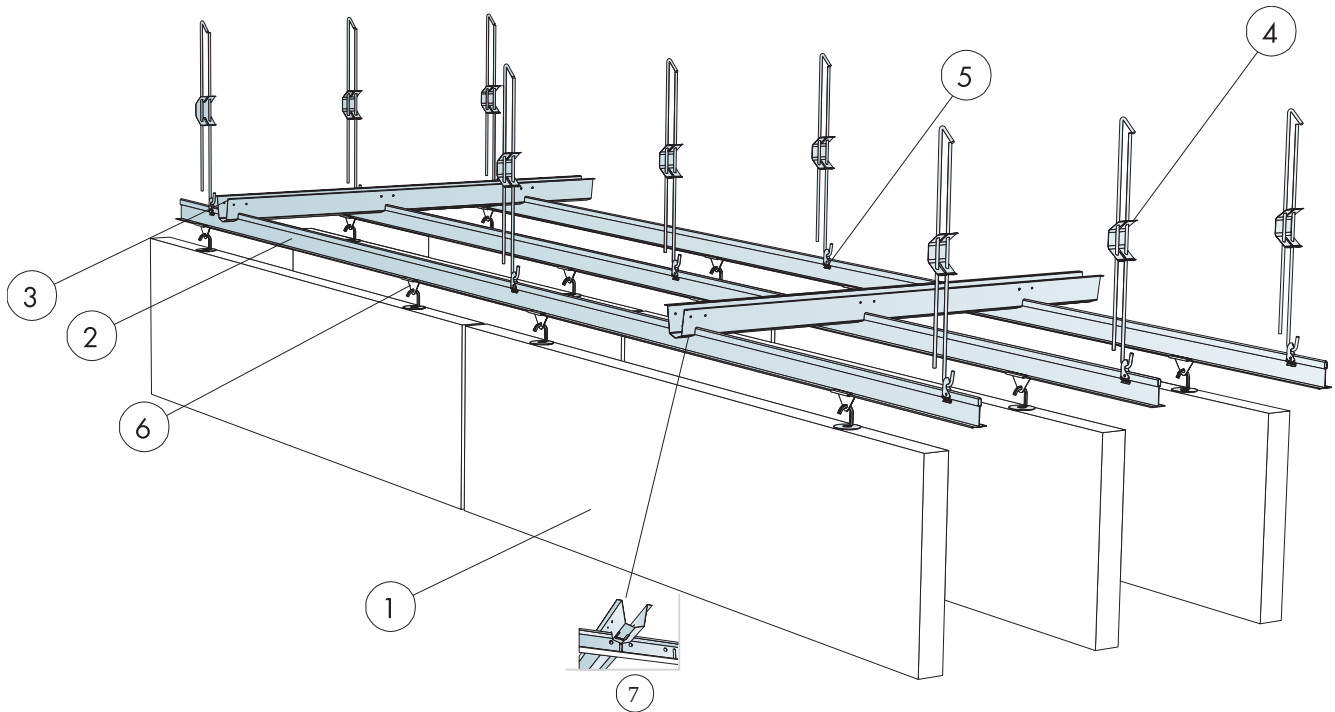

### QUANTITY SPECIFICATION (EXCL. WASTAGE)

	Size, mm					
	1200x200	1200x300	1200x600	1800x200	1800x300	1800x600
1 Solo Baffle/hook, installed at 600 mm centres	1,4/m <sup>2</sup>	1,4/m <sup>2</sup>	1,4/m <sup>2</sup>	1,9/m <sup>2</sup>	1,9/m <sup>2</sup>	1,9/m <sup>2</sup>
2 Connect T24 Main runner HD (Black, Grey) / Pt(White Only), installed at 600 mm centres	-	-	-	-	-	1,7m/m <sup>2</sup>
3 Connect Space bar	-	-	as required	-	-	as required
4 Connect Adjustable hanger (Alt 2) c1200	1,4/m <sup>2</sup>	1,4/m <sup>2</sup>	1,4/m <sup>2</sup>	1,4/m <sup>2</sup>	1,4/m <sup>2</sup>	1,4/m <sup>2</sup>
5	-	-	0,7/m <sup>2</sup>	-	-	-
6 Connect Baffle clip (Alt 2)	2,8/m <sup>2</sup>	2,8/m <sup>2</sup>	2,8/m <sup>2</sup>	2,8/m <sup>2</sup>	2,8/m <sup>2</sup>	2,8/m <sup>2</sup>
7 Connect Space bar winch, installed one per joint Main runner/Space bar	-	-	1,1/m <sup>2</sup>	-	-	1,1/m <sup>2</sup>
	-	-	-	-	-	-

# Ecophon Solo™ Baffle Wave

Solo Baffle Wave is vertically installed unframed baffles. The wave-shaped baffle gives the room a special design and possibility to express design in shape and colour. Baffles are used primarily when natural light is brought into the room via skylight.



Kurikka Campus, Kurikka, Finland

## SYSTEM RANGE



Size, mm	1800x300	1800x600
Special Fixing	•	•
Thickness (THK)	40	40
Inst. Diag.	M495, M419	M495, M419

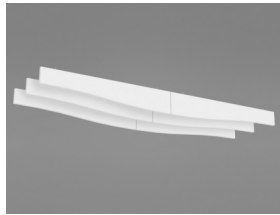

Solo Baffle Wave

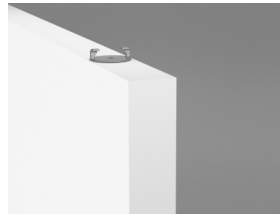

Solo Baffle Wave/anchor



Solo Baffle Wave/anchor installation

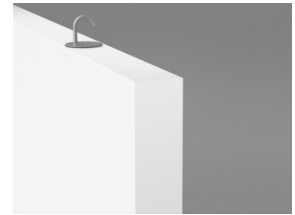

Solo Baffle Wave/hook

## Acoustic



### Sound Absorption:

Test results according to EN ISO 354:2003 NOTE: Results shown are not comparable with results according to older versions of this standard due to discrepancies in test method. Classification according to EN ISO 11654, and the single value ratings for Noise Reduction Coefficient, NRC and Sound Absorption Average, SAA according to ASTM C 423.

$\alpha_p$ , Practical sound absorption coefficient

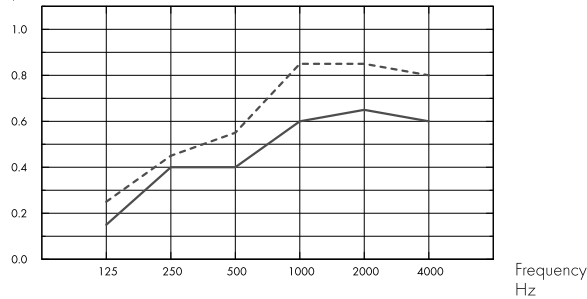

- Solo Baffle Wave 1800x300/200, spacing 600, direct mounting
  - Solo Baffle Wave 1800x600/300, spacing 600, direct mounting
- o.d.s = overall depth of system

$A_{eq}$ , Equivalent absorption area per unit (m<sup>2</sup> sabin)

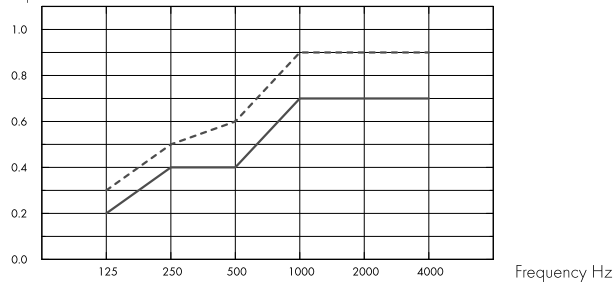

- Solo Baffle Wave 1800x300/200
  - Solo Baffle Wave 1800x600/300
- o.d.s = overall depth of system

	THK mm	o.d.s. mm	$\alpha_p$ , Practical sound absorption coefficient						$\alpha_w$
			125 Hz	250 Hz	500 Hz	1000 Hz	2000 Hz	4000 Hz	
c600	40	300	0.15	0.40	0.40	0.60	0.65	0.60	0.50
c600	40	600	0.25	0.45	0.55	0.85	0.85	0.80	0.65

	THK mm	o.d.s. mm	$A_{eq}$ , Equivalent absorption area per unit (m <sup>2</sup> sabin)					
			125 Hz	250 Hz	500 Hz	1000 Hz	2000 Hz	4000 Hz
c600	40	300	0.2	0.4	0.4	0.7	0.7	0.7
c600	40	600	0.3	0.5	0.6	0.9	0.9	0.9

	THK mm	o.d.s. mm	NRC	SAA
c600	40	300	0.50	0.52
c600	40	600	0.70	0.68



## Indoor Air Quality

Certificate / Label	
Eurofins Indoor Air Comfort®	IAC Gold
French VOC	A+



## Cradle to Cradle Certified®



This product is Cradle to Cradle Certified® at Bronze level (version 4.0).



## Material Health



This product has received a C2C Certified Material Health Certificate™ at the Silver level (standard version 4.0). The C2C Certified Material Health Certificate™ is a verification of the health and safety of a product's composition using the Material Health requirements of the Cradle-to-Cradle Certified Product Standard.



## Carbon footprint

	kg CO <sub>2</sub> equiv/m <sup>2</sup>	Life-cycle stages A1 to C4 from EPD, in conformity with ISO 14025 / EN 15804
Solo Baffle Wave	11,07	



## Circularity

Minimum post-consumer recycled content	57%
Recyclability	Fully recyclable



## Fire safety

Country	Fire standard	Class
Europe	EN 13501-1	A2-s1,d0

The glass wool core of the tiles is tested and classified as non-combustible according to EN ISO 1182.



## Humidity Resistance

Class C, relative humidity 95% and 30°C, according to EN 13964:2014



## Visual appearance

White Frost, nearest NCS colour sample S 0500-N, 85% light reflectance. Gloss < 1.



## Cleanability

Daily dusting and vacuum cleaning. Weekly wet wiping.



## Accessibility

The tiles are demountable.





## Installation

---

Installed according to installation diagrams, installation guides and drawing aid. For information regarding minimum overall depth of system see quantity specification.



## System weight

---

	kg/m <sup>2</sup>	Weight information is indicative and subject to variation.
Solo Baffle	4,6	



## Mechanical properties

---

Additional live load has to be fixed to the soffit.



## CE

---

Ecophon ceiling systems are CE marked according to the European harmonized standard EN 13964:2014. CE marked construction products are covered by a Declaration of Performance (DOP) which enables customers and users to easily compare performance of products available on the European market.

INSTALLATION DIAGRAM (M495) FOR ECOPHON SOLO BAFFLE WAVE/HOOK

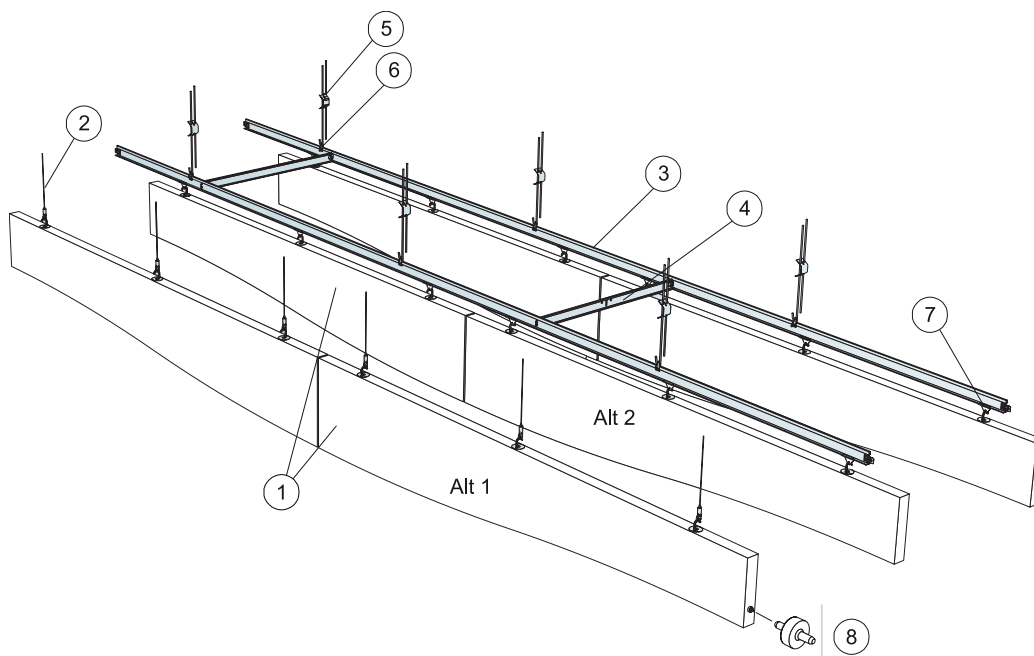

© Saint-Gobain Ecophon AB

QUANTITY SPECIFICATION (EXCL. WASTAGE)

	Size, mm	
	1800x300	1800x600
1 Solo Baffle/hook	0,9/m <sup>2</sup>	0,9/m <sup>2</sup>
2 Connect Adjustable wire hanger (Alt 1)	3/panel	3/panel
3 Connect T24 Main runner, installed at 600 mm centres (Alt 2)	1,7m/m <sup>2</sup>	1,7m/m <sup>2</sup>
4 Connect T24 Cross tee, L=600 mm, installed at 1800 mm centres (Alt 2)	0,6m/m <sup>2</sup>	0,6m/m <sup>2</sup>
5 Connect Adjustable hanger (Alt 2) c1200	1,4/m <sup>2</sup>	1,4/m <sup>2</sup>
6 Connect Hanger clip (Alt 2)	1,4/m <sup>2</sup>	1,4/m <sup>2</sup>
7 Connect Baffle clip (Alt 2)	2,8/m <sup>2</sup>	2,8/m <sup>2</sup>
8 Connect Guiding pin, installed at 1800 mm centres	0,9/m <sup>2</sup>	0,9/m <sup>2</sup>

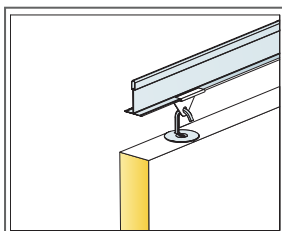

Detail of suspension

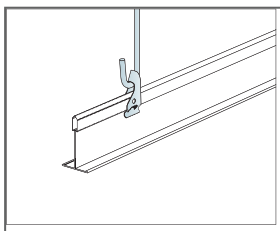

Suspension with adjustable hanger and clip

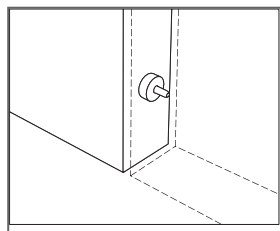

Connect Guiding pin, used to fix distance and level between panels

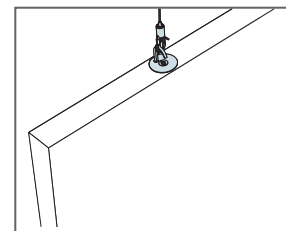

Suspension with Connect Adjustable wire hanger

## INSTALLATION DIAGRAM (M419) FOR ECOPHON SOLO BAFFLE WAVE ANCHOR

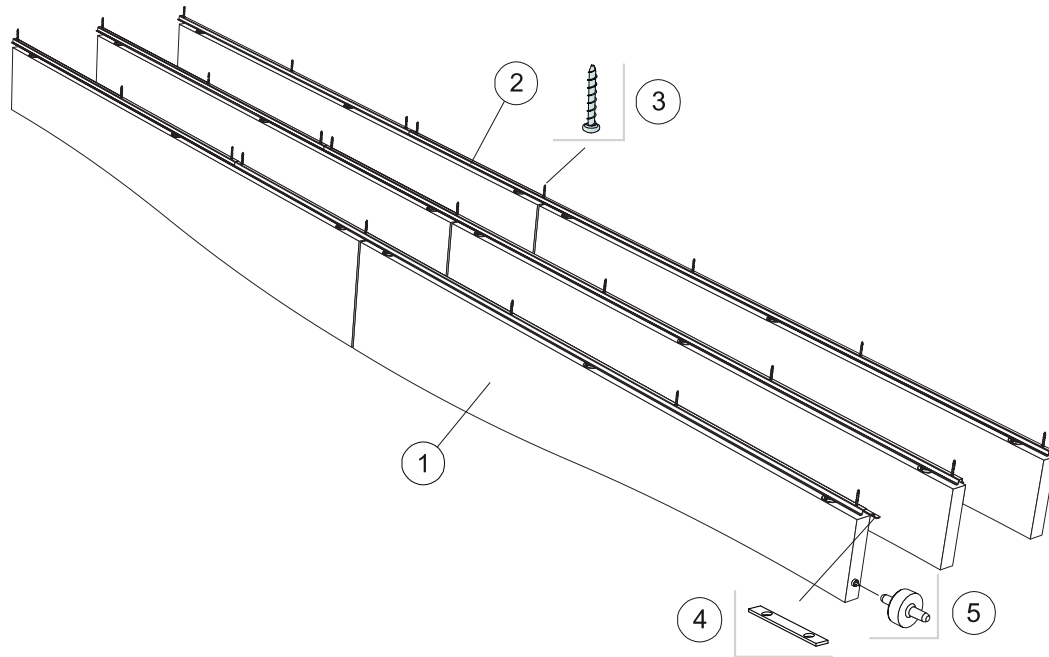

© Saint-Gobain Ecophon AB

### QUANTITY SPECIFICATION (EXCL. WASTAGE)

	Size, mm	
	1800x300	1800x600
1 Solo Baffle/anchor	1,9/m <sup>2</sup>	1,9/m <sup>2</sup>
2 Connect Baffle profile, installed at 300 mm centres	3,3m/m <sup>2</sup>	3,3m/m <sup>2</sup>
3 Connect Anchor screw, fixed at 1200 mm centres	2,8/m <sup>2</sup>	2,8/m <sup>2</sup>
4 Connect Profile connector, installed at 2400 mm centres	1,4/m <sup>2</sup>	1,4/m <sup>2</sup>
5 Connect Guiding pin, installed at 1800 mm centres	1,9/m <sup>2</sup>	1,9/m <sup>2</sup>

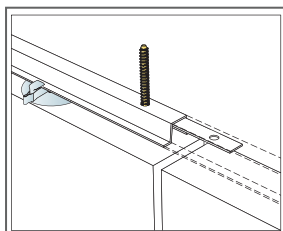

Fixing of Connect Profile connector

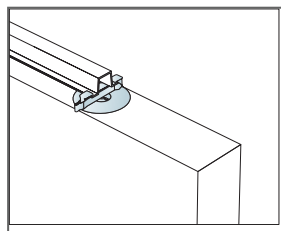

The baffles are secured with clips

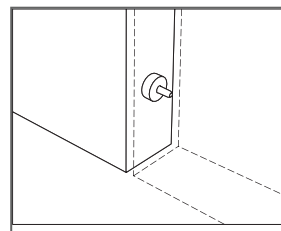

Connect Guiding pin, used to fix distance and level between panels

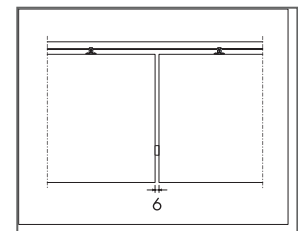

Distinct gap of 6 mm between baffles with Connect Guiding pin

# Ecophon Solo™ Baffle ZigZag

Solo Baffle ZigZag is vertically installed unframed baffles. The zigzag-shaped baffle gives the room a special design and possibility to express design in shape and colour. Baffles are used primarily when natural light is brought into the room via skylight.



## SYSTEM RANGE



Size, mm	1800x300	1800x600
Special Fixing	•	•
Thickness (THK)	40	40
Inst. Diagr.	M417	M417

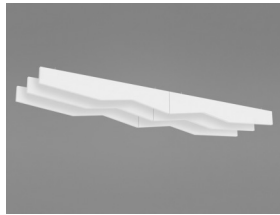

Solo Baffle ZigZag

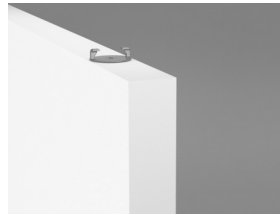

Solo Baffle ZigZag/anchor



Solo Baffle ZigZag/anchor installation

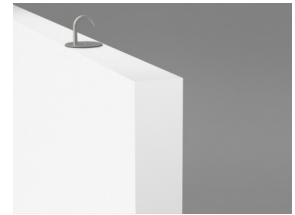

Solo Baffle ZigZag/hook

## Acoustic



### Sound Absorption:

Test results according to EN ISO 354:2003 NOTE: Results shown are not comparable with results according to older versions of this standard due to discrepancies in test method. Classification according to EN ISO 11654, and the single value ratings for Noise Reduction Coefficient, NRC and Sound Absorption Average, SAA according to ASTM C 423.

$\alpha_p$ , Practical sound absorption coefficient

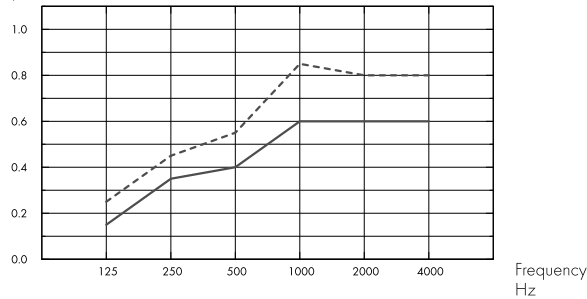

- Solo Baffle ZigZag 1800x300/200, spacing 600, direct mounting
  - Solo Baffle ZigZag 1800x600/300, spacing 600, direct mounting
- o.d.s = overall depth of system

$A_{eq}$ , Equivalent absorption area per unit (m<sup>2</sup> sabin)

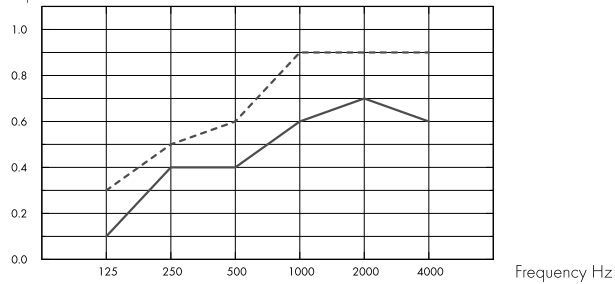

- Solo Baffle ZigZag 1800x300/200
  - Solo Baffle ZigZag 1800x600/300
- o.d.s = overall depth of system

	THK mm	o.d.s. mm	$\alpha_p$ , Practical sound absorption coefficient						$\alpha_w$
			125 Hz	250 Hz	500 Hz	1000 Hz	2000 Hz	4000 Hz	
c600	40	300	0.15	0.35	0.40	0.60	0.60	0.60	0.50
c600	40	600	0.25	0.45	0.55	0.85	0.80	0.80	0.65

	THK mm	o.d.s. mm	$A_{eq}$ , Equivalent absorption area per unit (m <sup>2</sup> sabin)					
			125 Hz	250 Hz	500 Hz	1000 Hz	2000 Hz	4000 Hz
c600	40	300	0.1	0.4	0.4	0.6	0.7	0.6
c600	40	600	0.3	0.5	0.6	0.9	0.9	0.9

	THK mm	o.d.s. mm	NRC	SAA
c600	40	300	0.50	0.49
c600	40	600	0.65	0.65



## Indoor Air Quality

Certificate / Label	
Eurofins Indoor Air Comfort®	IAC Gold
French VOC	A+



## Cradle to Cradle Certified®



This product is Cradle to Cradle Certified® at Bronze level (version 4.0).



## Material Health



This product has received a C2C Certified Material Health Certificate™ at the Silver level (standard version 4.0). The C2C Certified Material Health Certificate™ is a verification of the health and safety of a product's composition using the Material Health requirements of the Cradle-to-Cradle Certified Product Standard.



## Carbon footprint

	kg CO <sub>2</sub> equiv/m <sup>2</sup>	Life-cycle stages A1 to C4 from EPD, in conformity with ISO 14025 / EN 15804
Solo Baffle ZigZag	11,13	



## Circularity

Minimum post-consumer recycled content	57%
Recyclability	Fully recyclable



## Fire safety

Country	Fire standard	Class
Europe	EN 13501-1	A2-s1,d0

The glass wool core of the tiles is tested and classified as non-combustible according to EN ISO 1182.



## Humidity Resistance

Class C, relative humidity 95% and 30°C, according to EN 13964:2014



## Visual appearance

White Frost, nearest NCS colour sample S 0500-N, 85% light reflectance. Gloss < 1.



## Cleanability

Daily dusting and vacuum cleaning. Weekly wet wiping.



## Accessibility

The tiles are demountable.



## Installation

---

Installed according to installation diagrams, installation guides and drawing aid. For information regarding minimum overall depth of system see quantity specification.



## System weight

---

	kg/m <sup>2</sup>	Weight information is indicative and subject to variation.
Solo Baffle	4,6	



## Mechanical properties

---

Additional live load has to be fixed to the soffit.



## CE

---

Ecophon ceiling systems are CE marked according to the European harmonized standard EN 13964:2014. CE marked construction products are covered by a Declaration of Performance (DOP) which enables customers and users to easily compare performance of products available on the European market.

## INSTALLATION DIAGRAM (M417) FOR ECOPHON SOLO BAFFLE ZIGZAG ANCHOR

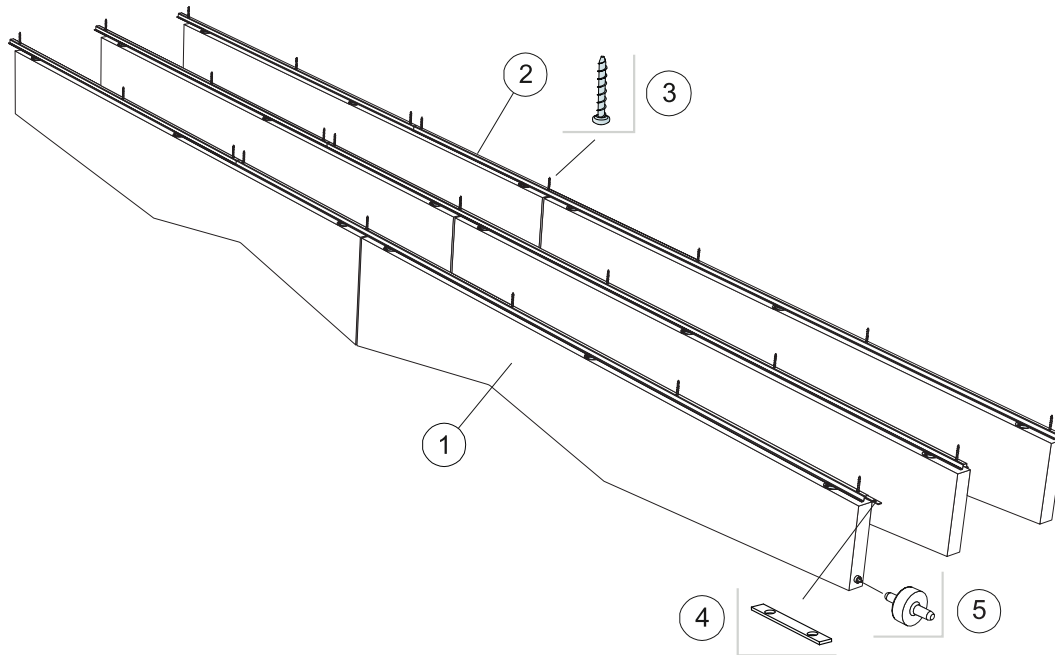

© Saint-Gobain Ecophon AB

### QUANTITY SPECIFICATION (EXCL. WASTAGE)

	Size, mm	
	1800x300	1800x600
1 Solo Baffle/anchor	1,9/m <sup>2</sup>	1,9/m <sup>2</sup>
2 Connect Baffle profile, installed at 300 mm centres	3,3m/m <sup>2</sup>	3,3m/m <sup>2</sup>
3 Connect Anchor screw, fixed at 1200 mm centres	2,8/m <sup>2</sup>	2,8/m <sup>2</sup>
4 Connect Profile connector, installed at 2400 mm centres	1,4/m <sup>2</sup>	1,4/m <sup>2</sup>
5 Connect Guiding pin, installed at 1800 mm centres	1,9/m <sup>2</sup>	1,9/m <sup>2</sup>

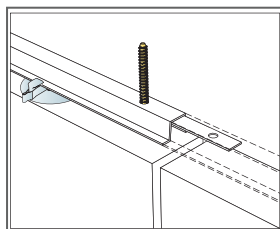

Fixing of Connect Profile connector

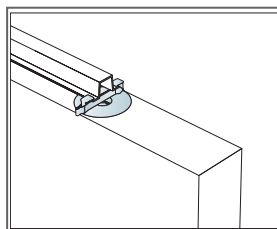

The baffles are secured with clips

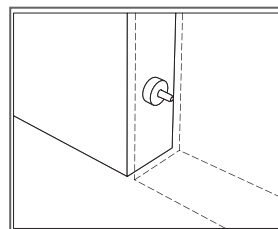

Connect Guiding pin, used to fix distance and level between panels

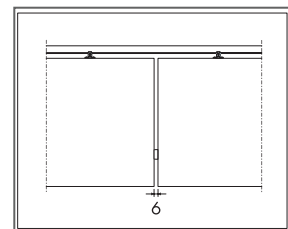

Distinct gap of 6 mm between baffles with Connect Guiding pin



# Ecophon Solo™ Baffle Wall

Ecophon Solo™ Baffle Wall are acoustic solutions for walls. Solo Baffle Wall are suitable in buildings where you want to express design and have freedom to create patterns with different sizes and colours.

With Connect™ Baffle wall fixing you will easily attach the baffle to the wall.



## SYSTEM RANGE



Size, mm	1200x200	1200x300
Special Fixing	•	•
Thickness (THK)	40	40
Inst. Diagr.	M420	M420

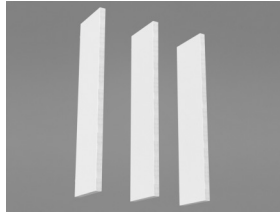

Solo Baffle Wall

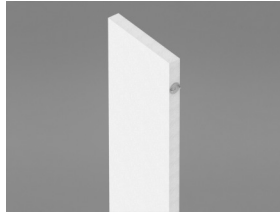

Solo Baffle/anchor

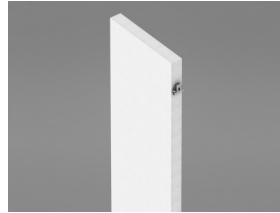

Solo Baffle/anchor with Connect Baffle Wall fixing

## Acoustic



For acoustic data on the Baffle - please see Solo Baffle.

## Indoor Air Quality



Certificate / Label	
Eurofins Indoor Air Comfort®	IAC Gold
French VOC	A+



## Cradle to Cradle Certified®



This product is Cradle to Cradle Certified® at Bronze level (version 4.0).



## Material Health



This product has received a C2C Certified Material Health Certificate™ at the Silver level (standard version 4.0). The C2C Certified Material Health Certificate™ is a verification of the health and safety of a product's composition using the Material Health requirements of the Cradle-to-Cradle Certified Product Standard.



## Carbon footprint

	kg CO <sub>2</sub> equiv/m <sup>2</sup>	Life-cycle stages A1 to C4 from EPD, in conformity with ISO 14025 / EN 15804
Solo Baffle & Solo Baffle Wall	10,11	



## Circularity

Minimum post-consumer recycled content	57%
Recyclability	Fully recyclable



## Fire safety

Country	Fire standard	Class
Europe	EN 13501-1	A2-s1,d0

The glass wool core of the tiles is tested and classified as non-combustible according to EN ISO 1182.



## Humidity Resistance

Class C, relative humidity 95% and 30°C, according to EN 13964:2014



## Visual appearance

White Frost, nearest NCS colour sample S 0500-N, 85% light reflectance. Gloss < 1.



### Cleanability

Daily dusting and vacuum cleaning. Weekly wet wiping.



### Accessibility

The tiles are demountable.



### System weight

	kg/m <sup>2</sup>	Weight information is indicative and subject to variation.
Solo Baffle	4,6	



### Installation

Installed according to installation diagrams, installation guides and drawing aid. For information regarding minimum overall depth of system see quantity specification.



### Mechanical properties

Additional live load has to be fixed to the soffit.



### CE

Ecophon ceiling systems are CE marked according to the European harmonized standard EN 13964:2014. CE marked construction products are covered by a Declaration of Performance (DOP) which enables customers and users to easily compare performance of products available on the European market.



### Carbon footprint

	kg CO <sub>2</sub> equiv/m <sup>2</sup>	Life-cycle stages A1 to C4 from EPD, in conformity with ISO 14025 / EN 15804
Solo Baffle & Solo Baffle Wall	10,11	

## INSTALLATION DIAGRAM (M420) FOR ECOPHON SOLO BAFFLE WALL

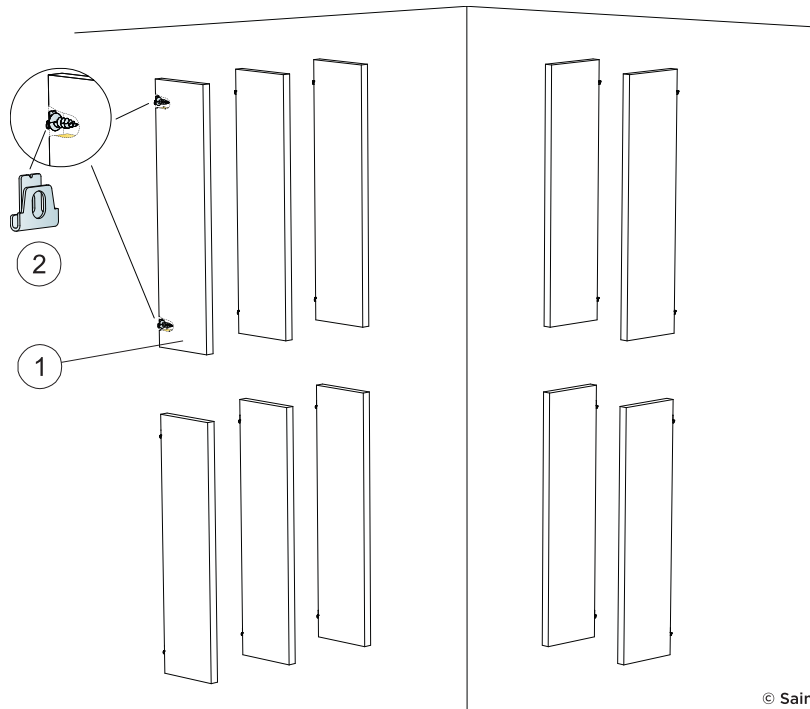

© Saint-Gobain Ecophon AB

### QUANTITY SPECIFICATION (EXCL. WASTAGE)

	Size, mm	
	1200x200	1200x300
1 Solo Baffle/anchor, installed at 300 mm centres	2,8/m <sup>2</sup>	2,8/m <sup>2</sup>
2 Connect Baffle wall fixing	2/panel	2/panel
$\Delta 1$ Min. overall depth of system: $\Delta 1$ 212mm / 312mm	-	-
$\Delta 2$ Min. overall depth of system: $\Delta 2$ 20mm	-	-
$\Delta 3$ Min. overall depth of system: $\Delta 3$ 2500mm	-	-

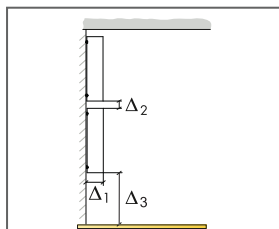

See Quantity specification

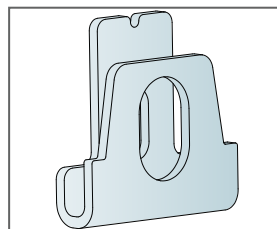

Detail of Connect Baffle wall bracket

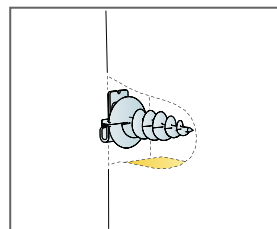

Detail of panel

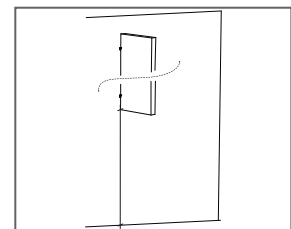

Mounting high min 2,5m.

# Ecophon Solo™ Matrix

The system provides quick and easy installation with highest accuracy and a vast range of design possibilities. Each panel has a built in hatch function, and can easily be demounted. Suitable for larger areas where high coverage is required but a wall to wall solution is not possible.



Nowy Styl Group, Kraków, Poland

## SYSTEM RANGE

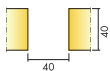

Size, mm	600x1040	600x1200	600x2400	1200x1040	1200x1200	2400x1040	2400x1200
T24	•	•	•	•	•	•	•
Thickness (THK)	40	40	40	40	40	40	40
Inst. Diagr.	M502	M501, M503	M501, M503	M502	M501	M502	M501

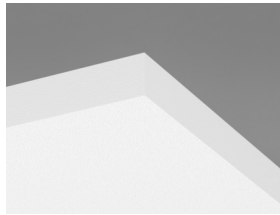

Master Solo panel

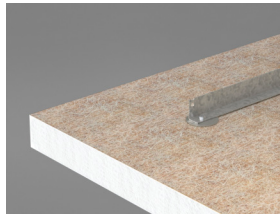

Connect Panel Cross Bar on rear side of Solo Matrix panel

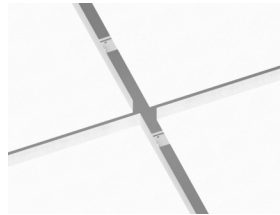

Solo Matrix system



Section of Solo Matrix system

## Acoustic



The first diagram refers to clusters >10 m<sup>2</sup>. The second diagram to a cluster of four panels (1200x1040 mm) in a row with a distance of 40 mm (M502). If the clusters are arranged with distances between the clusters <0,5 meters, the Aeq per cluster will be slightly reduced.

## Sound Absorption:

Test results according to EN ISO 354. Classification according to EN ISO 11654.

$\alpha_p$ , Practical sound absorption coefficient

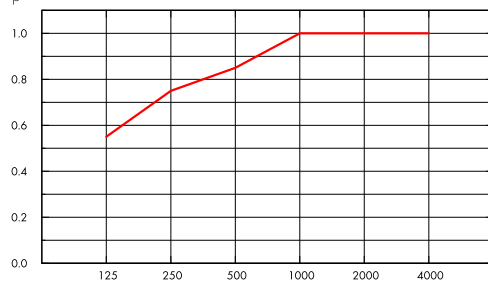

— Solo Matrix 40 mm, 300 mm o.d.s.  
o.d.s = overall depth of system

$A_{eq}$ , Equivalent absorption area per unit (m<sup>2</sup> sabin)

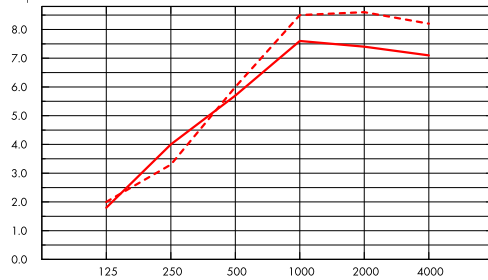

— Solo Matrix 40 mm (M502), 300 mm o.d.s.  
- - - Solo Matrix 40 mm (M502), 600 mm o.d.s.  
o.d.s = overall depth of system

THK mm	o.d.s. mm	$\alpha_p$ , Practical sound absorption coefficient						$\alpha_w$	Sound absorption class
		125 Hz	250 Hz	500 Hz	1000 Hz	2000 Hz	4000 Hz		
40	300	0.55	0.75	0.85	1.00	1.00	1.00	0.95	A

THK mm	o.d.s. mm	$A_{eq}$ , Equivalent absorption area per unit (m <sup>2</sup> sabin)					
		125 Hz	250 Hz	500 Hz	1000 Hz	2000 Hz	4000 Hz
40	300	1.8	4.0	5.7	7.6	7.4	7.1
40	600	2.0	3.3	6.0	8.5	8.6	8.2
40	1000	2.1	3.5	6.4	9.1	9.2	9.0



## Indoor Air Quality

Certificate / Label	
Eurofins Indoor Air Comfort®	IAC Gold
French VOC	A+



## Cradle to Cradle Certified®



This product is Cradle to Cradle Certified® at Bronze level (version 4.0).



## Material Health



This product has received a C2C Certified Material Health Certificate™ at the Silver level (standard version 4.0). The C2C Certified Material Health Certificate™ is a verification of the health and safety of a product's composition using the Material Health requirements of the Cradle-to-Cradle Certified Product Standard.



## Carbon footprint

kg CO <sub>2</sub> equiv./m <sup>2</sup>		Life-cycle stages A1 to C4 from EPD, in conformity with ISO 14025 / EN 15804
Solo Matrix	7,52	



## Circularity

Minimum post-consumer recycled content	62%
Recyclability	Fully recyclable



## Fire safety

Country	Fire standard	Class
Europe	EN 13501-1	A2-s1,d0

The glass wool core of the tiles is tested and classified as non-combustible according to EN ISO 1182.



## Humidity Resistance

Class C, relative humidity 95% and 30°C, according to EN 13964:2014



## Visual appearance

White Frost, nearest NCS colour sample S 0500-N, 85% light reflectance. Gloss < 1.



## Cleanability

Daily dusting and vacuum cleaning. Weekly wet wiping.



## Accessibility

Each panel is individually demountable from below. Panels are equipped with hatch function.



## Installation

---

For design possibilities including installation direction and integrations, see installation guides, installation diagrams and drawing aid. For information regarding minimum overall depth of system see quantity specification.



## System weight

---

	kg/m <sup>2</sup>	Weight information is indicative and subject to variation.
Solo Matrix	3,5	
Solo Matrix + Connect Grid System	4,5	



## Mechanical properties

---

The panels can take small loads with largest aperture diameter of 100 mm. The load is restricted to maximum 250g between two Panel cross bars. For heavier loads see Installation guide.



## CE

---

Ecophon ceiling systems are CE marked according to the European harmonized standard EN13964:2014. CE marked construction products are covered by a Declaration of Performance (DOP) which enables customers and users to easily compare performance of products available on the European market.



## INSTALLATION DIAGRAM (M501) FOR ECOPHON SOLO MATRIX IN MODULES

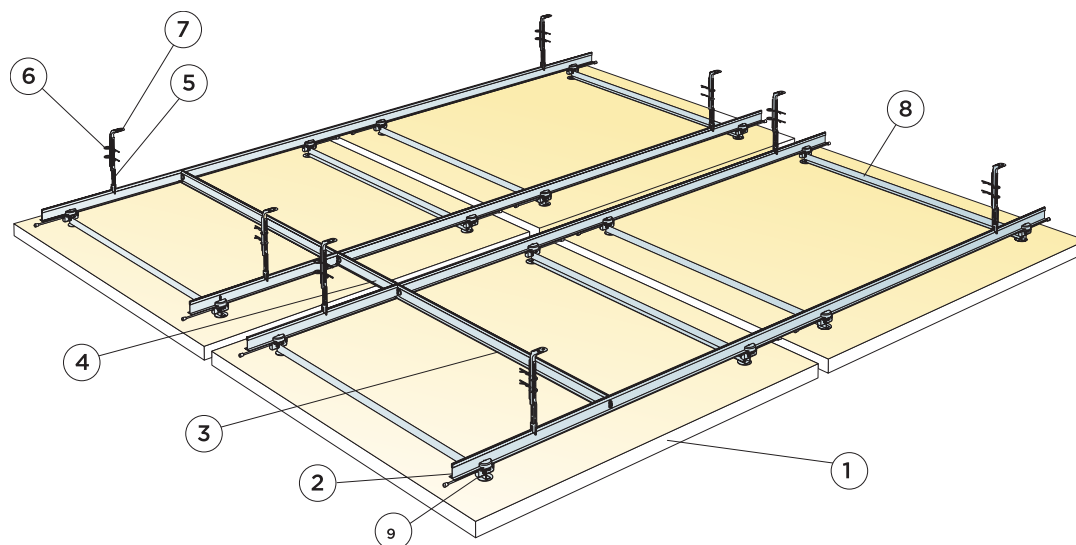

© Saint-Gobain Ecophon AB

### QUANTITY SPECIFICATION (EXCL. WASTAGE)

	Size, mm			
	600x1200	600x2400	1200x1200	2400x1200
1 Solo Matrix	0,72m <sup>2</sup> / tile	1,44m <sup>2</sup> / tile	1,44m <sup>2</sup> / tile	2,88m <sup>2</sup> / tile
2 Connect T24 Main runner, installed with spacing 900 mm and 300 mm	1,67m <sup>2</sup> /m <sup>2</sup>	1,67m <sup>2</sup> /m <sup>2</sup>	1,67m <sup>2</sup> /m <sup>2</sup>	1,67m <sup>2</sup> /m <sup>2</sup>
3 Connect T24 Cross tee, L=900 mm, installed with spacing 1800 mm	0,42m <sup>2</sup> /m <sup>2</sup>	0,42m <sup>2</sup> /m <sup>2</sup>	0,42m <sup>2</sup> /m <sup>2</sup>	0,42m <sup>2</sup> /m <sup>2</sup>
4 Connect T24 Cross tee, L=300 mm, installed with spacing 2400 mm	0,11m <sup>2</sup> /m <sup>2</sup>	0,11m <sup>2</sup> /m <sup>2</sup>	0,11m <sup>2</sup> /m <sup>2</sup>	0,11m <sup>2</sup> /m <sup>2</sup>
5 Connect Nonius Hanger Lower, installed with spacing 1800 mm	0,95/m <sup>2</sup>	0,95/m <sup>2</sup>	0,95/m <sup>2</sup>	0,95/m <sup>2</sup>
6 Connect Split pin (2/hanger)	1,9/m <sup>2</sup>	1,9/m <sup>2</sup>	1,9/m <sup>2</sup>	1,9/m <sup>2</sup>
7 Connect Nonius hanger upper, installed with spacing 1800 mm	0,95/m <sup>2</sup>	0,95/m <sup>2</sup>	0,95/m <sup>2</sup>	0,95/m <sup>2</sup>
8 Connect Panel cross bar	2/panel	4/panel	2/panel	3/panel
9 Connect Panel connector	4/panel	8/panel	4/panel	6/panel
Δ Min. overall depth of system: 305 mm	-	-	-	-
Quantity specification based on 40 mm gap between all panels	-	-	-	-
Stabilization could be required, see installation guide for more details	-	-	-	-

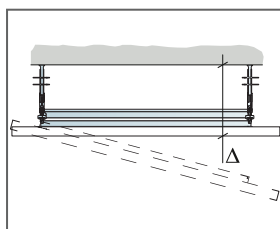

See Quantity specification

Modular size	Exact size
600x1200	560x1160
600x2400	560x2360
1200x1200	1160x1160
2400x1200	2360x1160

The left column shows modular sizes and the right exact panel sizes.

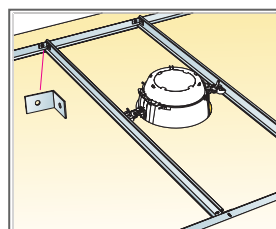

For heavier integrations use Connect Cross Tee and Connect Angle Bracket.

Size, mm	Max live load [N]	Min load bearing capacity [N]
600x1200x40	5	160
600x2400x40	5	160
1200x1200x40	5	160
2400x1200x40	5	160

Live load/load bearing capacity

## INSTALLATION DIAGRAM (M502) FOR ECOPHON SOLO MATRIX IN ROWS

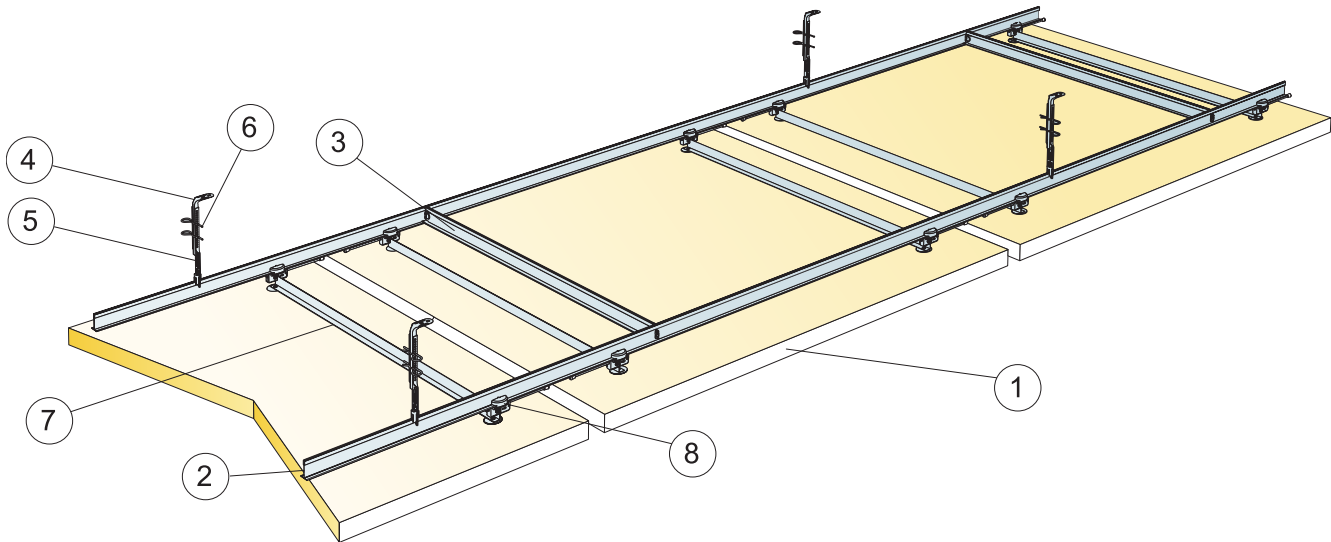

© Saint-Gobain Ecophon AB

### QUANTITY SPECIFICATION (EXCL. WASTAGE)

	Size, mm		
	600x1040	1200x1040	2400x1040
1 Ecophon Master Matrix in rows	0,63m <sup>2</sup> /panel	1,25m <sup>2</sup> /panel	2,50m <sup>2</sup> /panel
2 Connect T24 Main runner, installed with spacing 900 mm	1,93m/m <sup>2</sup>	1,93m/m <sup>2</sup>	1,93m/m <sup>2</sup>
3 Connect T24 Cross tee, L=900 mm, installed with spacing 1800 mm	0,49m/m <sup>2</sup>	0,49m/m <sup>2</sup>	0,49m/m <sup>2</sup>
4 Connect Nonius hanger upper, installed with spacing 1800 mm	1,07/m <sup>2</sup>	1,07/m <sup>2</sup>	1,07/m <sup>2</sup>
5 Connect Nonius Hanger Lower, installed with spacing 1800 mm	1,07/m <sup>2</sup>	1,07/m <sup>2</sup>	1,07/m <sup>2</sup>
6 Connect Split pin (2/hanger)	2,14/m <sup>2</sup>	2,14/m <sup>2</sup>	2,14/m <sup>2</sup>
7 Connect Panel cross bar	2/panel	2/panel	3/panel
8 Connect Panel connector	4/panel	4/panel	6/panel
Δ Min. overall depth of system: 305 mm	-	-	-
Quantity specification based on 40 mm gap between panels in installation direction	-	-	-
Stabilization could be required, see installation guide for more details	-	-	-

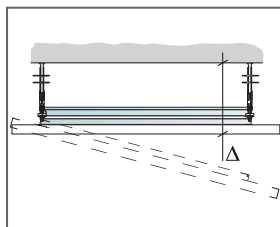

See Quantity specification

Modular size	Exact size
600x1040	560x1000
1200x1040	1160x1000
2400x1040	2360x1000

The left column shows modular sizes and the right exact panel sizes.

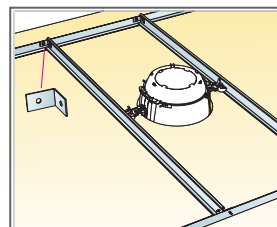

For heavier integrations use Connect Cross Tee and Connect Angle Bracket.

Size, mm	Max live load [N]	Min load bearing capacity [N]
600x1040x40	5	160
1200x1040x40	5	160
2400x1040x40	5	160

Live load/load bearing capacity

## INSTALLATION DIAGRAM (M503) FOR ECOPHON SOLO MATRIX IN MODULES

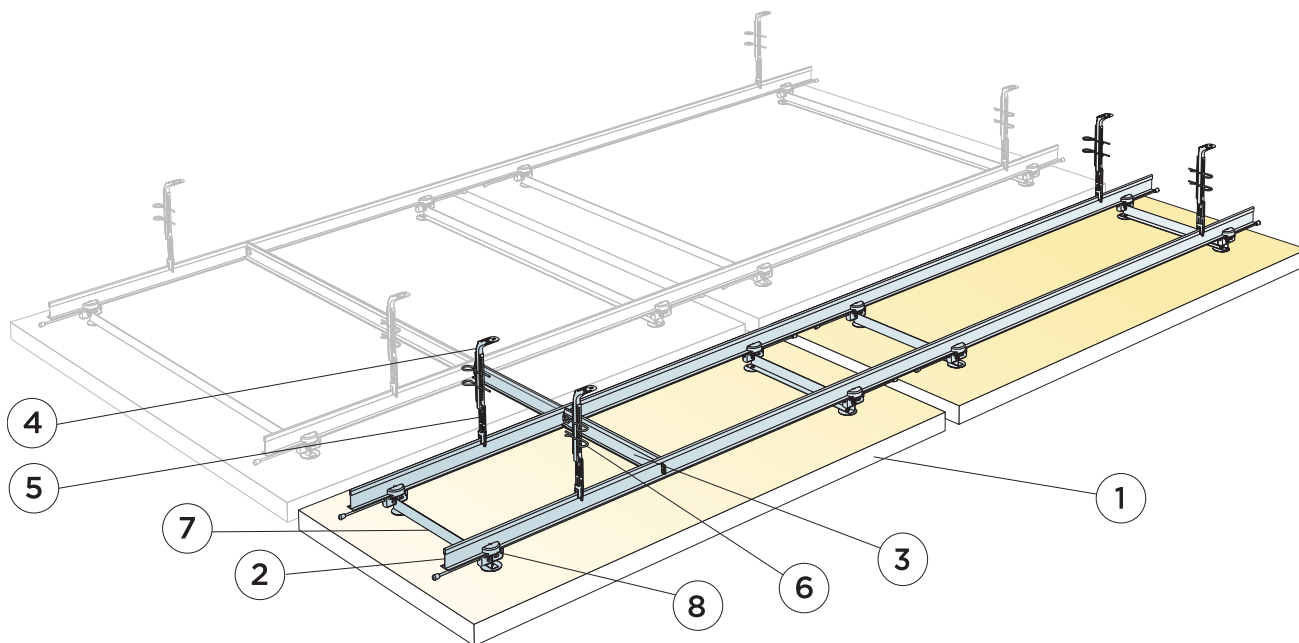

© Saint-Gobain Ecophon AB

### QUANTITY SPECIFICATION (EXCL. WASTAGE)

	Size, mm	
	600x1200	600x2400
1 Solo Matrix	0,72m <sup>2</sup> /panel	1,44m <sup>2</sup> /panel
2 Connect T24 Main runner, installed with spacing 900 mm and 300 mm	1,67m/m <sup>2</sup>	1,67m/m <sup>2</sup>
3 Connect T24 Cross tee, L=300 mm, installed with spacing 2400 mm	0,11m/m <sup>2</sup>	0,11m/m <sup>2</sup>
4 Connect Nonius hanger upper, installed with spacing 1800 mm	0,95/m <sup>2</sup>	0,95/m <sup>2</sup>
5 Connect Nonius Hanger Lower, installed with spacing 1800 mm	0,95/m <sup>2</sup>	0,95/m <sup>2</sup>
6 Connect Split pin (2/hanger)	1,9/m <sup>2</sup>	1,9/m <sup>2</sup>
7 Connect Panel cross bar	2/panel	4/panel
8 Connect Panel connector	4/panel	8/panel
Δ Min. overall depth of system: 305 mm	-	-
Quantity specification based on 40 mm gap between all panels	-	-
Stabilization could be required, see installation guide for more details	-	-

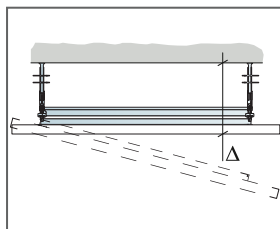

See Quantity specification

Modular size	Exact size
600x1200	560x1160
600x2400	560x2360
1200x1200	1160x1160
2400x1200	2360x1160

The left column shows modular sizes and the right exact panel sizes.

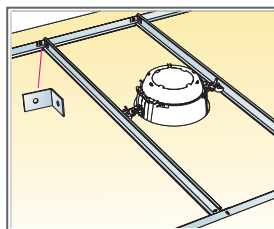

For heavier integrations use Connect Cross Tee and Connect Angle Bracket.

Size, mm	Max live load [N]	Min load bearing capacity [N]
600x1200x40	5	160
600x2400x40	5	160

Live load/load bearing capacity



# Ecophon Solo™ Circle Akutex HS

Solo Circle Akutex HS is a water resistant free hanging unit, offering a high degree of design possibility. Solo Circle Akutex HS is primarily suited for swimming pool areas with high humidity and occasional direct water.



## SYSTEM RANGE

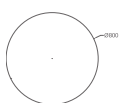

Size, mm	Ø800	Ø1200
Special Fixing	•	•
Thickness (THK)	40	40
Inst. Diagr.	M437C4	M442C4



Solo Circle Akutex HS



Solo Circle Akutex HS tile

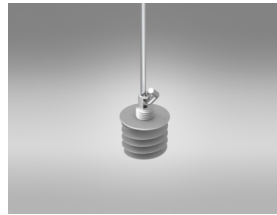

Suspension with Connect Adjustable Hanger C4 and Connect Absorber Anchor

## Acoustic



The values in the diagram refer to a single unit. If the units are arranged in a cluster with distances between units less than 0,5 meters, the Aeq per unit will be slightly reduced.

### Sound Absorption:

Test results according to EN ISO 354.

A<sub>eq</sub>, Equivalent absorption area per unit (m<sup>2</sup> sabin)

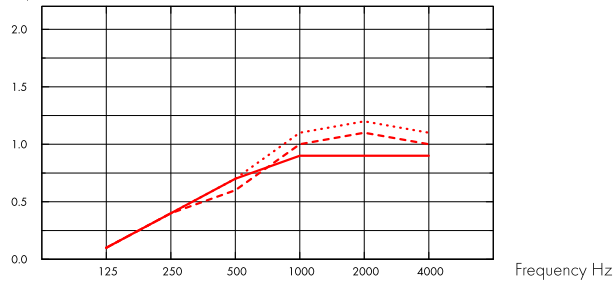

- Solo Circle/Akutex HS Ø800, 200 mm o.d.s.
  - - - Solo Circle/Akutex HS Ø800, 400 mm o.d.s.
  - ... Solo Circle/Akutex HS Ø800, 1000 mm o.d.s.
- o.d.s = overall depth of system

A<sub>eq</sub>, Equivalent absorption area per unit (m<sup>2</sup> sabin)

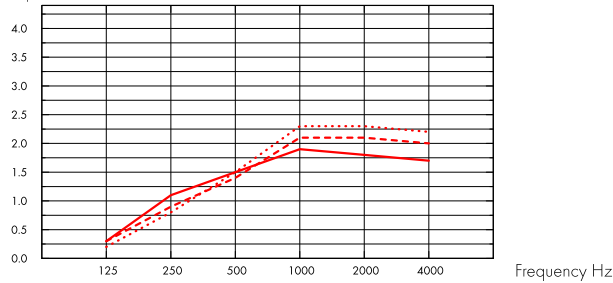

- Solo Circle/Akutex HS Ø1200, 200 mm o.d.s.
  - - - Solo Circle/Akutex HS Ø1200, 400 mm o.d.s.
  - ... Solo Circle/Akutex HS Ø1200, 1000 mm o.d.s.
- o.d.s = overall depth of system

	THK mm	o.d.s. mm	A <sub>eq</sub> , Equivalent absorption area per unit (m <sup>2</sup> sabin)					
			125 Hz	250 Hz	500 Hz	1000 Hz	2000 Hz	4000 Hz
Ø800	40	200	0.1	0.4	0.7	0.9	0.9	0.9
Ø800	40	400	0.1	0.4	0.6	1.0	1.1	1.0
Ø800	40	1000	0.1	0.4	0.7	1.1	1.2	1.1

	THK mm	o.d.s. mm	A <sub>eq</sub> , Equivalent absorption area per unit (m <sup>2</sup> sabin)					
			125 Hz	250 Hz	500 Hz	1000 Hz	2000 Hz	4000 Hz
Ø1200	40	200	0.3	1.1	1.5	1.9	1.8	1.7
Ø1200	40	400	0.3	0.9	1.4	2.1	2.1	2.0
Ø1200	40	1000	0.2	0.8	1.5	2.3	2.3	2.2



## Indoor Air Quality

Certificate / Label	
Eurofins Indoor Air Comfort®	IAC Gold
French VOC	A+



## Cradle to Cradle Certified®



This product is Cradle to Cradle Certified® at Bronze level (version 4.0).



## Material Health



This product has received a C2C Certified Material Health Certificate™ at the Silver level (standard version 4.0). The C2C Certified Material Health Certificate™ is a verification of the health and safety of a product's composition using the Material Health requirements of the Cradle-to-Cradle Certified Product Standard.



## Carbon footprint

kg CO <sub>2</sub> equiv/m <sup>2</sup>		Life-cycle stages A1 to C4 from EPD, in conformity with ISO 14025 / EN 15804
Solo Circle/Akutex HS	10,87	



## Circularity

Minimum post-consumer recycled content	54%
Recyclability	Fully recyclable



## Fire safety

Country	Fire standard	Class
Europe	EN 13501-1	A2-s1,d0

The glass wool core of the tiles is tested and classified as non-combustible according to EN ISO 1182.



## Humidity Resistance

Class C, relative humidity 95% and 30°C, according to EN 13964:2014



## Visual appearance

White 500, nearest NCS colour sample S 0500-N, 84% light reflectance.



## Cleanability

Daily dusting and vacuum cleaning. Weekly wet wiping.



## Accessibility

The tiles are demountable.



## Installation

---

Installed according to installation diagrams, installation guides and drawing aid. For information regarding minimum overall depth of system see quantity specification.



## System weight

---

	kg/m <sup>2</sup>	Weight information is indicative and subject to variation.
Solo Circle/Akutex HS	4,9	



## Mechanical properties

---

No additional live load is allowed.



## CE

---

Ecophon ceiling systems are CE marked according to the European harmonized standard EN 13964:2014. CE marked construction products are covered by a Declaration of Performance (DOP) which enables customers and users to easily compare performance of products available on the European market.

## INSTALLATION DIAGRAM (M437C4) FOR ECOPHON SOLO CIRCLE AKUTEX HS C4

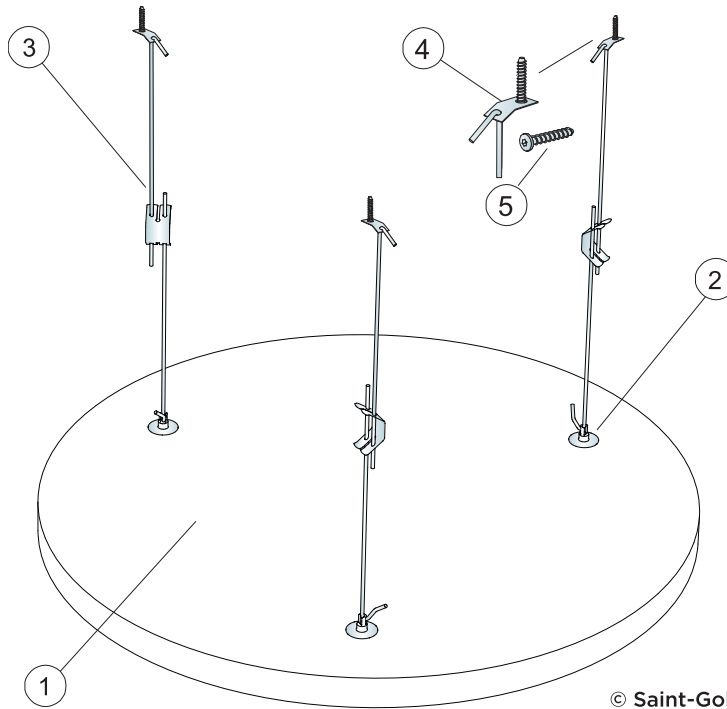

© Saint-Gobain Ecophon AB

### QUANTITY SPECIFICATION (EXCL. WASTAGE)

		Size, mm
		Ø800
1	Solo Circle Akutex HS	0,5m <sup>2</sup> /panel
2	Connect Absorber Anchor	3/panel
3	Connect Adjustable Hanger C4	3/panel
4	Connect Fixing plate C4	3/panel
5	Connect Anchor screw C4	3/panel
Δ Min. overall depth of system: Δ 410 mm		-

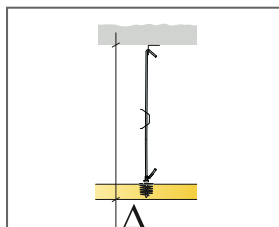

See Quantity Specification

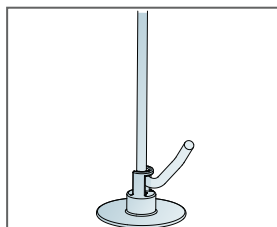

Connect Adjustable Hanger C4 mounted in Connect Absorber Anchor

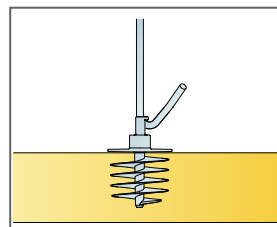

Connect Absorber Anchor mounted in panel

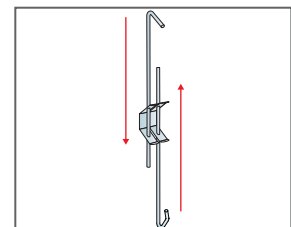

Adjustable suspension with Connect Adjustable Hanger C4



## INSTALLATION DIAGRAM (M442C4) FOR ECOPHON SOLO™ CIRCLE AKUTEX HS C4

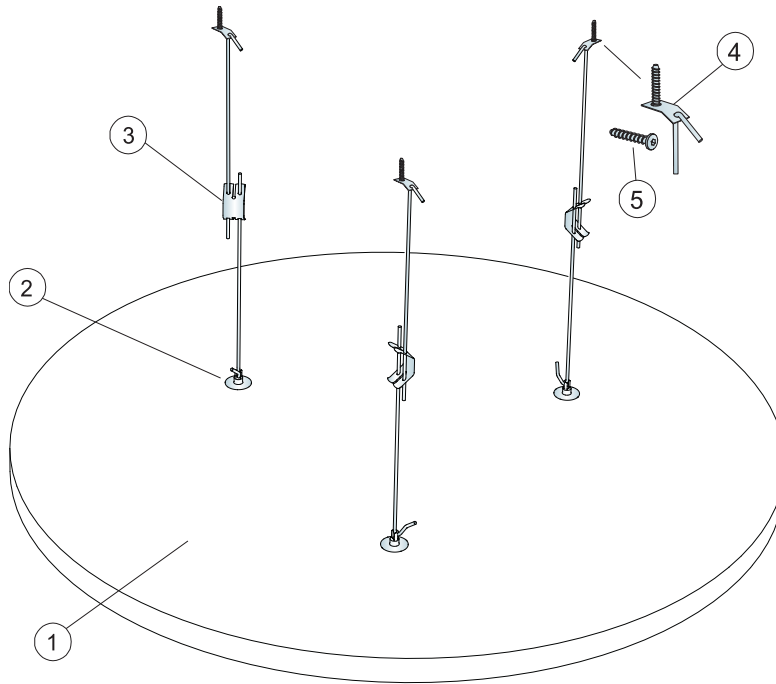

© Saint-Gobain Ecophon AB

### QUANTITY SPECIFICATION (EXCL. WASTAGE)

		Size, mm
		Ø1200
1	Solo Circle Akutex HS	1,13m <sup>2</sup> /panel
2	Connect Absorber Anchor	3/panel
3	Connect Adjustable Hanger C4	3/panel
4	Connect Fixing plate C4	3/panel
5	Connect Anchor screw C4	3/panel
Δ Min. overall depth of system: Δ 410 mm		-

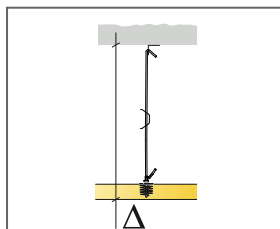

See Quantity Specification

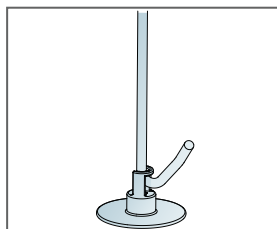

Connect Adjustable Hanger C4 mounted in Connect Absorber Anchor

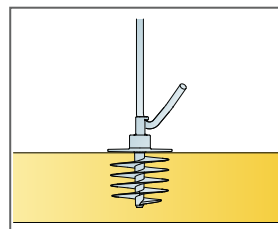

Connect Absorber Anchor mounted in panel

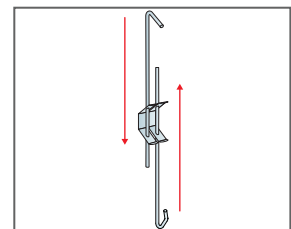

Adjustable suspension with Connect Adjustable Hanger C4



# Ecophon Solo™ Square Akutex HS

Solo Square Akutex HS is a water resistant free hanging unit, offering a high degree of design possibility. Solo Square Akutex HS is primarily suited for swimming pool areas with high humidity and occasional direct water.



## SYSTEM RANGE

<input type="checkbox"/>	Size, mm	1200x1200
	Special Fixing	•
	Thickness (THK)	40
	Inst. Diagr.	M438C4

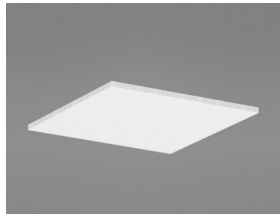

Solo Square Akutex HS

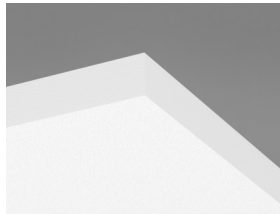

Solo Rectangle Akutex HS tile



Suspension with Connect Adjustable Hanger C4 and Connect Absorber Anchor

## Acoustic



The values in the diagram refer to a single unit. If the units are arranged in a cluster with distances between units less than 0,5 meters, the Aeq per unit will be slightly reduced.

### Sound Absorption:

Test results according to EN ISO 354.

$A_{eq}$  Equivalent absorption area per unit (m<sup>2</sup> sabin)

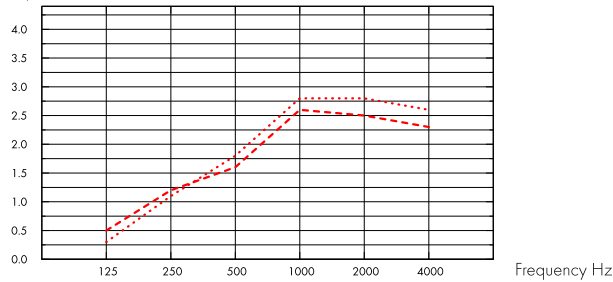

--- Solo Square 1200x1200/Akutex HS, 400 mm o.d.s.

.... Solo Square 1200x1200/Akutex HS, 1000 mm o.d.s.

o.d.s = overall depth of system

THK mm	o.d.s. mm	$A_{eq}$ Equivalent absorption area per unit (m <sup>2</sup> sabin)					
		125 Hz	250 Hz	500 Hz	1000 Hz	2000 Hz	4000 Hz
40	400	0.5	1.2	1.6	2.6	2.5	2.3
40	1000	0.3	1.1	1.8	2.8	2.8	2.6

## Indoor Air Quality



Certificate / Label

Eurofins Indoor Air Comfort®

IAC Gold

French VOC

A+



## Cradle to Cradle Certified®



This product is Cradle to Cradle Certified® at Bronze level (version 4.0).



## Material Health



This product has received a C2C Certified Material Health Certificate™ at the Silver level (standard version 4.0). The C2C Certified Material Health Certificate™ is a verification of the health and safety of a product's composition using the Material Health requirements of the Cradle-to-Cradle Certified Product Standard.



## Carbon footprint

	kg CO <sub>2</sub> equiv/m <sup>2</sup>
Solo Square	9,37

Life-cycle stages A1 to C4 from EPD, in conformity with ISO 14025 / EN 15804



## Circularity

Minimum post-consumer recycled content	54%
Recyclability	Fully recyclable



## Fire safety

Country	Fire standard	Class
Europe	EN 13501-1	A2-s1,d0

The glass wool core of the tiles is tested and classified as non-combustible according to EN ISO 1182.



## Humidity Resistance

Class C, relative humidity 95% and 30°C, according to EN 13964:2014



## Visual appearance

White 500, nearest NCS colour sample S 0500-N, 84% light reflectance.



## Cleanability

Daily dusting and vacuum cleaning. Weekly wet wiping.



## Accessibility

The tiles are demountable.



## Installation

Installed according to installation diagrams, installation guides and drawing aid. For information regarding minimum overall depth of system see quantity specification.



## System weight

	kg/m <sup>2</sup>
Solo Square/Akutex HS	4,9

Weight information is indicative and subject to variation.



## Mechanical properties

No additional live load is allowed.



## CE

Ecophon ceiling systems are CE marked according to the European harmonized standard EN 13964:2014. CE marked construction products are covered by a Declaration of Performance (DOP) which enables customers and users to easily compare performance of products available on the European market.

## INSTALLATION DIAGRAM (M438C4) FOR ECOPHON SOLO™ SQUARE AKUTEX HS C4

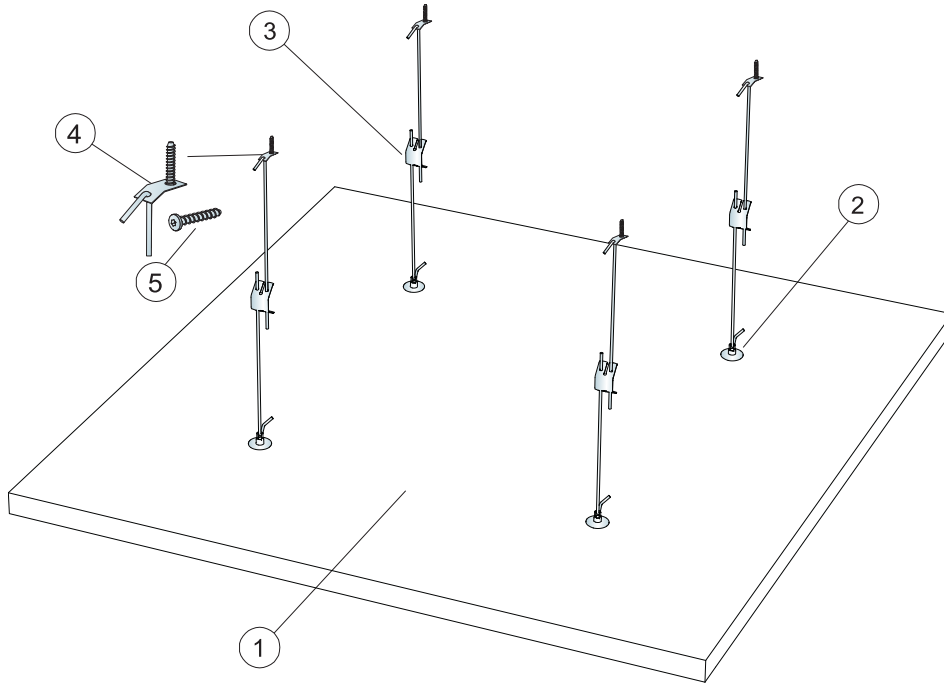

© Saint-Gobain Ecophon AB

### QUANTITY SPECIFICATION (EXCL. WASTAGE)

		Size, mm
		<b>1200x1200</b>
1	Solo Square Akutex HS	1,44m <sup>2</sup> /panel
2	Connect Absorber Anchor	4/panel
3	Connect Adjustable Hanger C4	4/panel
4	Connect Fixing plate C4	4/panel
5	Connect Anchor screw C4	4/panel
Δ Min. overall depth of system: Δ 410 mm		-

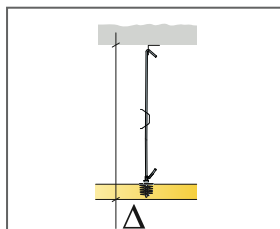

See Quantity Specification

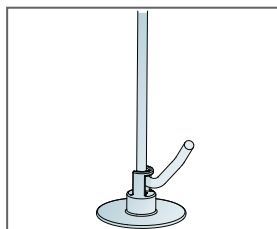

Connect Adjustable Hanger C4 mounted in Connect Absorber Anchor

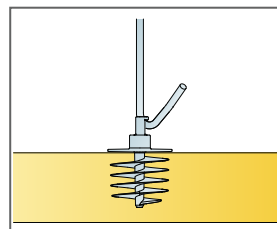

Connect Absorber Anchor mounted in panel

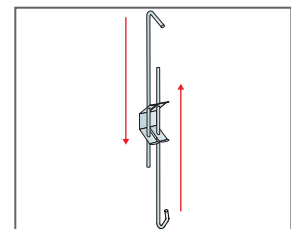

Adjustable suspension with Connect Adjustable Hanger C4



# Ecophon Solo™ Rectangle Akutex HS

Solo Rectangle Akutex HS is a water resistant free hanging unit, offering a high degree of design possibility. Solo Rectangle Akutex HS is primarily suited for swimming pool areas with high humidity and occasional direct water.



## SYSTEM RANGE

	Size, mm	1800x1200	2400x1200
	Special Fixing	•	•
	Thickness (THK)	40	40
	Inst. Diag.	M436C4	M441C4

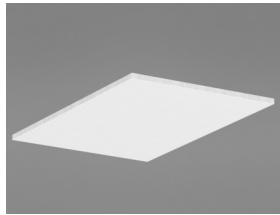

Solo Rectangle Akutex HS

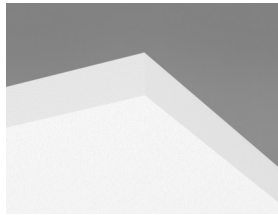

Solo Rectangle Akutex HS tile

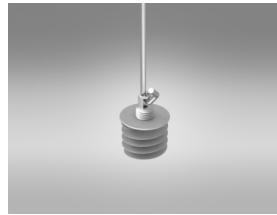

Suspension with Connect Adjustable Hanger C4 and Connect Absorber Anchor

## Acoustic



The values in the diagram refer to a single unit. If the units are arranged in a cluster with distances between units less than 0,5 meters, the Aeq per unit will be slightly reduced.

### Sound Absorption:

Test results according to EN ISO 354.

A<sub>eq</sub>, Equivalent absorption area per unit (m<sup>2</sup> sabin)

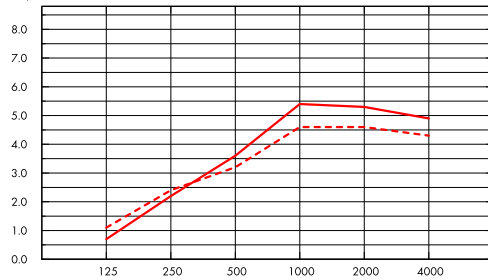

- Solo Rectangle 2400x1200/Akutex HS, 400 mm o.d.s.
  - Solo Rectangle 2400x1200/Akutex HS, 1000 mm o.d.s.
- o.d.s = overall depth of system

Frequency Hz

A<sub>eq</sub>, Equivalent absorption area per unit (m<sup>2</sup> sabin)

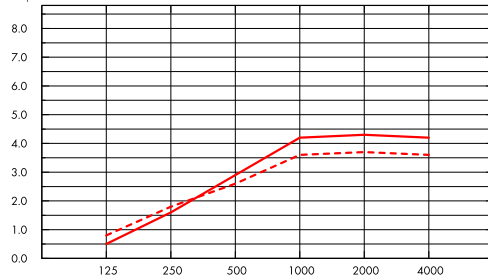

- Solo Rectangle 1800x1200/Akutex HS, 400 mm o.d.s.
  - Solo Rectangle 1800x1200/Akutex HS, 1000 mm o.d.s.
- o.d.s = overall depth of system

Frequency Hz

	THK mm	o.d.s. mm	A <sub>eq</sub> , Equivalent absorption area per unit (m <sup>2</sup> sabin)					
			125 Hz	250 Hz	500 Hz	1000 Hz	2000 Hz	4000 Hz
2400x1200	40	400	1.1	2.4	3.2	4.6	4.6	4.3
2400x1200	40	1000	0.7	2.2	3.6	5.4	5.3	4.9
1800x1200	40	400	0.8	1.8	2.6	3.6	3.7	3.6
1800x1200	40	1000	0.5	1.6	2.9	4.2	4.3	4.2

## Indoor Air Quality



Certificate / Label

Eurofins Indoor Air Comfort®

IAC Gold

French VOC

A+





## Cradle to Cradle Certified®



This product is Cradle to Cradle Certified® at Bronze level (version 4.0).



## Material Health



This product has received a C2C Certified Material Health Certificate™ at the Silver level (standard version 4.0). The C2C Certified Material Health Certificate™ is a verification of the health and safety of a product's composition using the Material Health requirements of the Cradle-to-Cradle Certified Product Standard.



## Carbon footprint

	kg CO <sub>2</sub> equiv/m <sup>2</sup>	Life-cycle stages A1 to C4 from EPD, in conformity with ISO 14025 / EN 15804
Solo Rectangle	9,64	



## Circularity

Minimum post-consumer recycled content	54%
Recyclability	Fully recyclable



## Fire safety

Country	Fire standard	Class
Europe	EN 13501-1	A2-s1,d0

The glass wool core of the tiles is tested and classified as non-combustible according to EN ISO 1182.



## Humidity Resistance

Class C, relative humidity 95% and 30°C, according to EN 13964:2014



## Visual appearance

White 500, nearest NCS colour sample S 0500-N, 84% light reflectance.



## Cleanability

Daily dusting and vacuum cleaning. Weekly wet wiping.



## Accessibility

The tiles are demountable.



## Installation

Installed according to installation diagrams, installation guides and drawing aid. For information regarding minimum overall depth of system see quantity specification.



## System weight

	kg/m <sup>2</sup>	Weight information is indicative and subject to variation.
Solo Rectangle Akutex HS	4,9	





### **Mechanical properties**

---

No additional live load is allowed.



### **CE**

---

Ecophon ceiling systems are CE marked according to the European harmonized standard EN 13964:2014. CE marked construction products are covered by a Declaration of Performance (DOP) which enables customers and users to easily compare performance of products available on the European market.

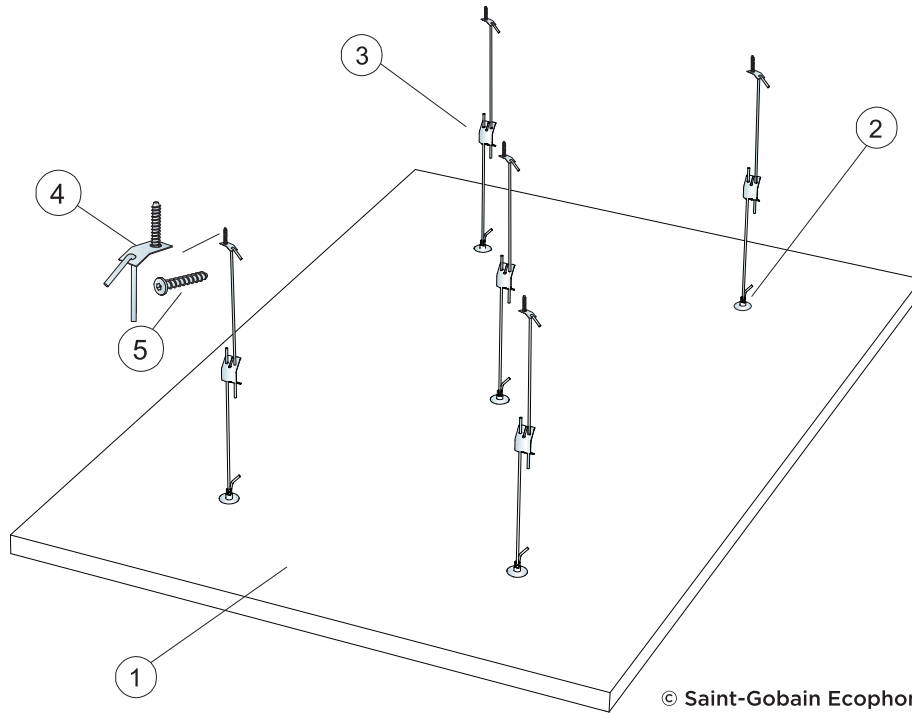

© Saint-Gobain Ecophon AB

### QUANTITY SPECIFICATION (EXCL. WASTAGE)

		Size, mm
		1800x1200
1	Solo Rectangle Akutex HS	2,16m <sup>2</sup> /panel
2	Connect Absorber Anchor	5/panel
3	Connect Adjustable Hanger C4	5/panel
4	Connect Fixing plate C4	5/panel
5	Connect Anchor screw C4	5/panel
Δ Min. overall depth of system: Δ 410 mm		-

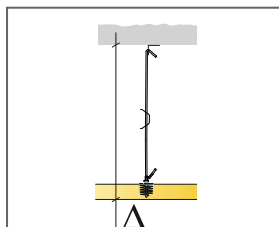

See Quantity Specification

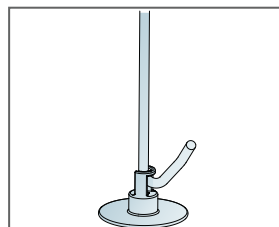

Connect Adjustable Hanger C4 mounted in Connect Absorber Anchor

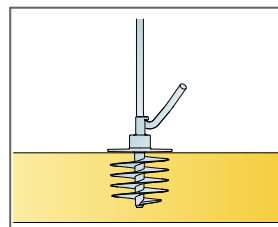

Connect Absorber Anchor mounted in panel

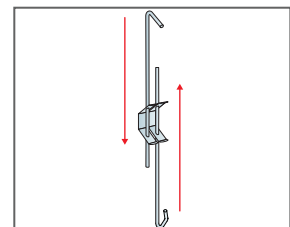

Adjustable suspension with Connect Adjustable Hanger C4

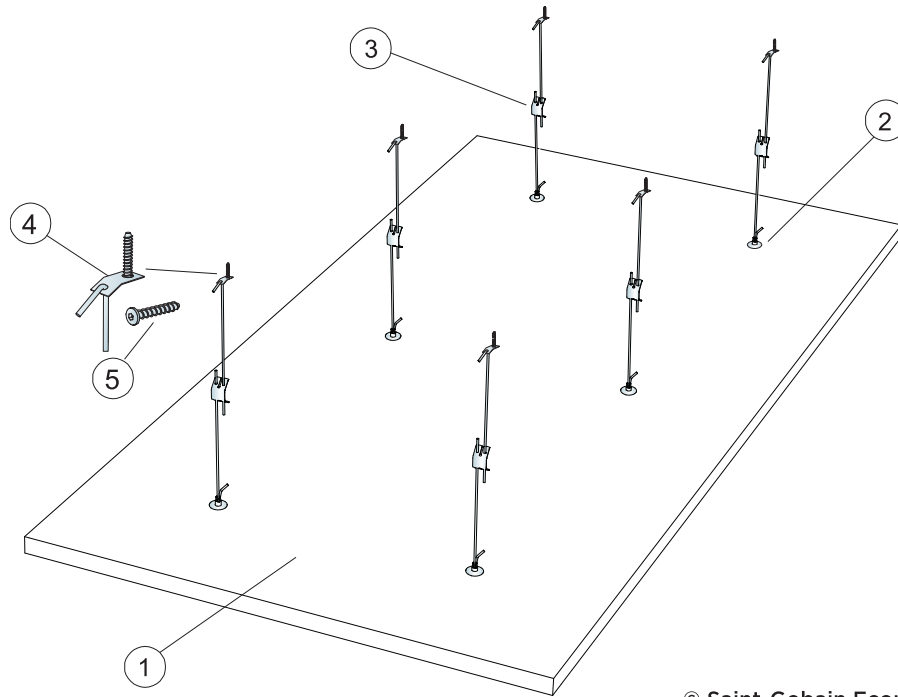

© Saint-Gobain Ecophon AB

### QUANTITY SPECIFICATION (EXCL. WASTAGE)

		Size, mm
		<b>2400x1200</b>
1	Solo Rectangle Akutex HS	2,88m <sup>2</sup> /panel
2	Connect Absorber Anchor	6/panel
3	Connect Adjustable Hanger C4	6/panel
4	Connect Fixing plate C4	6/panel
5	Connect Anchor screw C4	6/panel
Δ Min. overall depth of system: Δ 410 mm		-

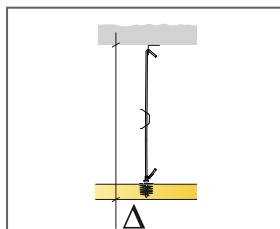

See Quantity Specification

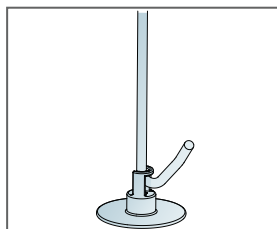

Connect Adjustable Hanger C4 mounted in Connect Absorber Anchor

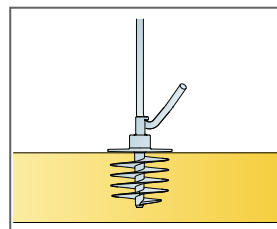

Connect Absorber Anchor mounted in panel

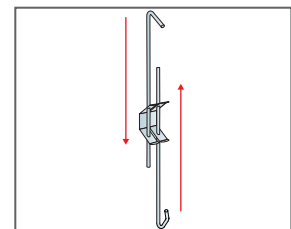

Adjustable suspension with Connect Adjustable Hanger C4