

Ecophon Solo™ Square

Solo Square is a free hanging unit, offering high level design possibilities. Three different suspension systems offer opportunities to create several layers and angles. Suitable when the room volume should be maintained or when it's not possible to install a wall-to-wall ceiling.



Impol Papier, Bardo (Dobroskiel) Poland

SYSTEM RANGE

	Size, mm	1200x1200
	Special Fixing	•
	Thickness	40
	Inst. Diagr.	M402, M507

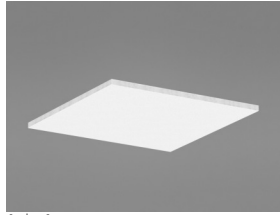

Solo Square

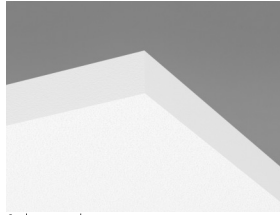

Solo panel

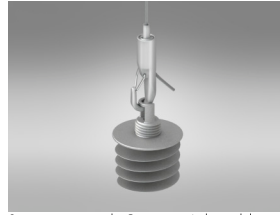

Suspension with Connect Adjustable wire hanger and Connect Absorber anchor



Suspension with Connect Adjustable wire hanger and Connect Absorber anchor

Acoustic



The values in the diagram refer to a single unit. If the units are arranged in a cluster with distances between units less than 0,5 meters, the Aeq per unit will be slightly reduced.

Sound Absorption:

Test results according to EN ISO 354.

A_{eq}: Equivalent absorption area per unit (m² sabin)

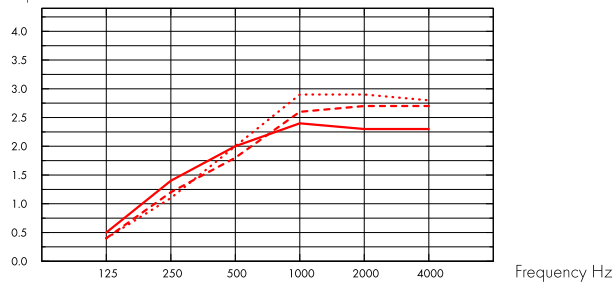

- Solo Square 1200x1200, 200 mm o.d.s.
 - - - Solo Square 1200x1200, 400 mm o.d.s.
 - ... Solo Square 1200x1200, 1000 mm o.d.s.
- o.d.s = overall depth of system

THK mm	o.d.s. mm	A _{eq} : Equivalent absorption area per unit (m ² sabin)					
		125 Hz	250 Hz	500 Hz	1000 Hz	2000 Hz	4000 Hz
40	200	0.5	1.4	2.0	2.4	2.3	2.3
40	400	0.4	1.2	1.8	2.6	2.7	2.7
40	1000	0.4	1.1	2.0	2.9	2.9	2.8

Indoor Air Quality



Certificate / Label

Eurofins Indoor Air Comfort®

IAC Gold

French VOC

A+



Cradle to Cradle Certified®



This product is Cradle to Cradle Certified® at Bronze level (version 4.0).



Material Health

This product has received a C2C Certified Material Health Certificate™ at the Silver level (standard version 4.0). The C2C Certified Material Health Certificate™ is a verification of the health and safety of a product's composition using the Material Health requirements of the Cradle-to-Cradle Certified Product Standard.



Carbon footprint

	kg CO ₂ equiv/m ²
Solo Square	9,37

Life-cycle stages A1 to C4 from EPD, in conformity with ISO 14025 / EN 15804



Circularity

Minimum post-consumer recycled content	57%
Recyclability	Fully recyclable



Fire safety

Country	Fire standard	Class
Europe	EN 13501-1	A2-s1,d0

The glass wool core of the tiles is tested and classified as non-combustible according to EN ISO 1182.



Humidity Resistance

Class C, relative humidity 95% and 30°C, according to EN 13964:2014



Visual appearance

White Frost, nearest NCS colour sample S 0500-N, 85% light reflectance. Gloss < 1.



Cleanability

Daily dusting and vacuum cleaning. Weekly wet wiping.



Accessibility

The tiles are demountable.



Installation

Installed according to installation diagrams, installation guides and drawing aid. For information regarding minimum overall depth of system see quantity specification.



System weight

	kg/m ²
Solo Square	4,6
Solo Freedom	4,6

Weight information is indicative and subject to variation.



Mechanical properties

The tile can take both point loads and distributed loads. See Functional demands, Mechanical properties at www.ecophon.com.



CE

Ecophon ceiling systems are CE marked according to the European harmonized standard EN13964:2014. CE marked construction products are covered by a Declaration of Performance (DOP) which enables customers and users to easily compare performance of products available on the European market.

INSTALLATION DIAGRAM (M402) FOR ECOPHON SOLO SQUARE

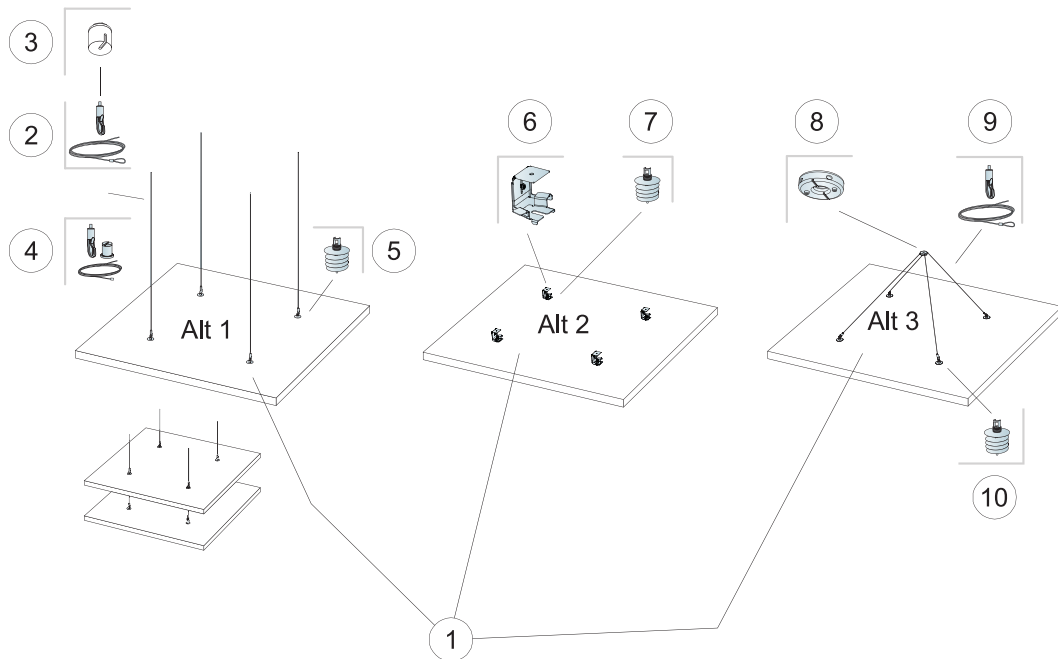

QUANTITY SPECIFICATION (EXCL. WASTAGE)

		Size, mm
		1200x1200
1	Solo Square	1,44m ² /panel
2	Connect Adjustable wire hanger (Alt 1)	4/panel
3	Connect Covering cup (Alt 1, Optional)	4/panel
4	Connect Adjustable wire kit (Alt 1, Optional)	4/panel
5	Connect Absorber anchor (Alt 1)	4/panel
6	Connect Absorber bracket (Alt 2)	4/panel
7	Connect Absorber anchor (Alt 2)	4/panel
8	Connect One-point fixing (Alt 3)	1/panel
9	Connect Adjustable wire hanger (Alt 3)	2/panel
10	Connect Absorber anchor (Alt 3)	4/panel
Δ Min. overall depth of system: $\Delta 1$ 140 mm / $\Delta 2$ 90 mm / $\Delta 3$ 500 mm		-

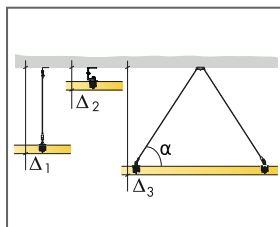

See Quantity specification

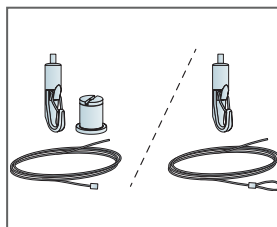

Two types of Adjustable wire solutions

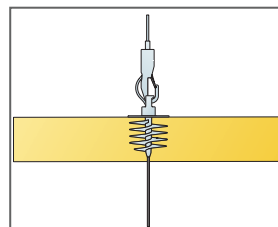

Panels can be suspended underneath each other

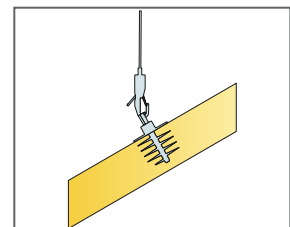

Panels can be installed in angles

INSTALLATION DIAGRAM (M507) FOR ECOPHON SOLO SQUARE KIT

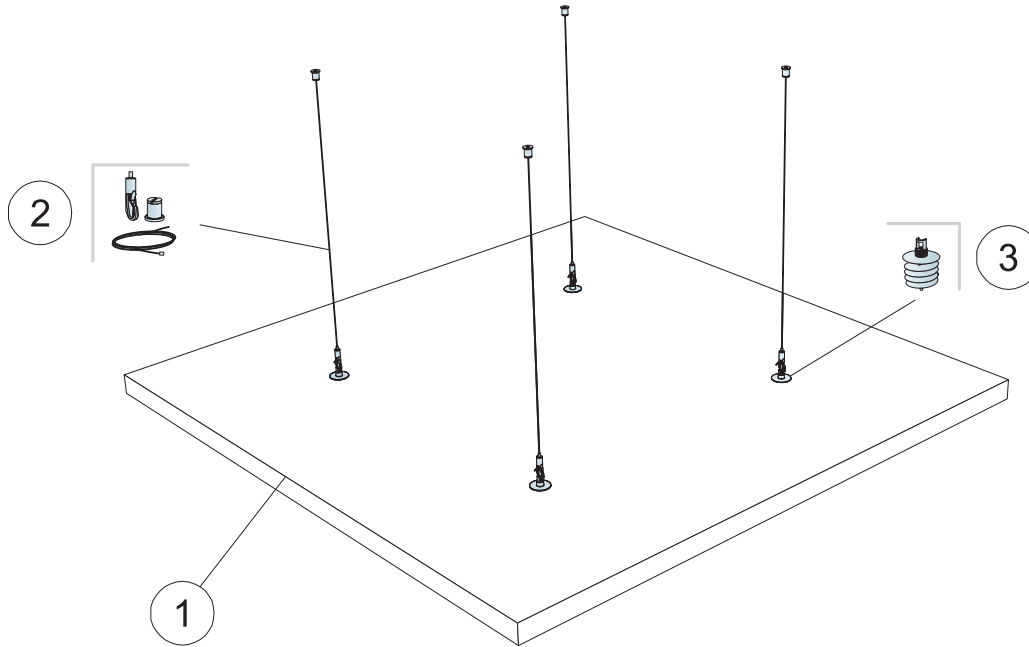

QUANTITY SPECIFICATION (EXCL. WASTAGE)

		Size, mm
		1200x1200
1	Solo Square Kit	1,44m ² /panel
2	Connect Adjustable wire kit 1500mm (included)	-
3	Connect Absorber anchor (included)	-
Δ Min. overall depth of system: Δ 140 mm		-
To install Connect Absorber Anchor, use Connect Absorber Anchor Bit.		-

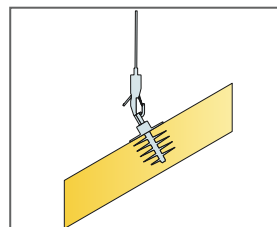
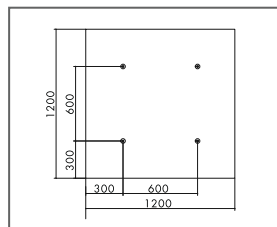
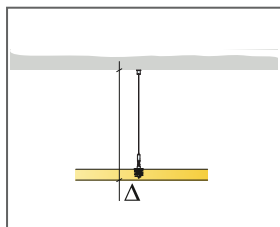

Panels can be installed in angles

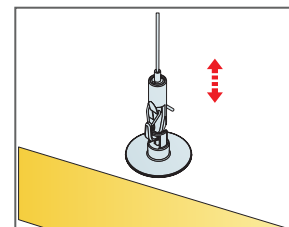

Easily adjustable suspension with Connect Adjustable wire hanger

Ecophon Solo™ Rectangle

Solo Rectangle is a free hanging unit, offering high level design possibilities. Three different suspension systems offer opportunities to create several layers and angles. Suitable when the room volume should be maintained or when it's not possible to install a wall-to-wall ceiling.



M30 Achlieeden, Oisterwijk, Netherlands

SYSTEM RANGE

	Size, mm	1200x600	1800x1200	2400x600	2400x1200	3000x1200
	Special Fixing	•	•	•	•	•
	Thickness	40	40	40	40	40
	Inst. Diag.	M637	M404, M506	M405	M406, M407, M506	M408

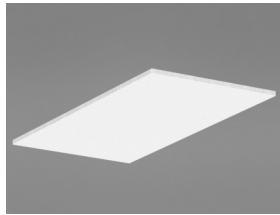

Solo Rectangle

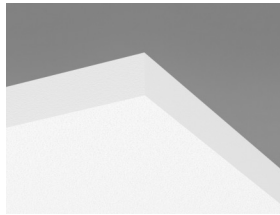

Solo panel

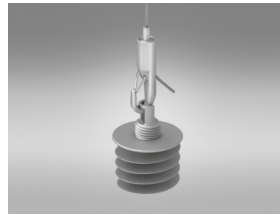

Suspension with Connect Adjustable wire hanger and Connect Absorber anchor



Suspension with Connect Adjustable wire hanger and Connect Absorber anchor

Acoustic



The values in the diagram refer to a single unit. If the units are arranged in a cluster with distances between units less than 0,5 meters, the Aeq per unit will be slightly reduced.

Sound Absorption:

Test results according to EN ISO 354.

A_{eq} , Equivalent absorption area per unit (m² sabin)

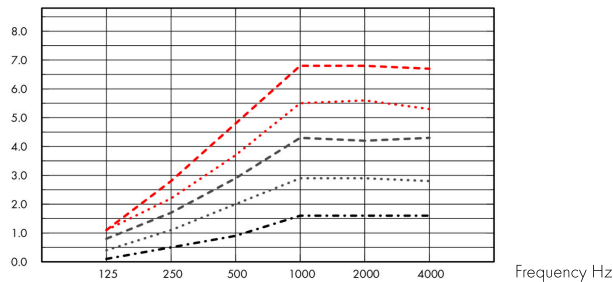

- Solo Rectangle 2400x1200, 1000 mm o.d.s.
 - Solo Rectangle 1800x1200, 1000 mm o.d.s.
 - Solo Rectangle 2400x600, 1000 mm o.d.s.
 - Solo Rectangle 3000x1200, 1000 mm o.d.s.
 - Solo Rectangle 1200x600, 1000 mm o.d.s.
- o.d.s = overall depth of system

	THK mm	o.d.s. mm	A_{eq} , Equivalent absorption area per unit (m ² sabin)					
			125 Hz	250 Hz	500 Hz	1000 Hz	2000 Hz	4000 Hz
2400x1200	40	200	1.3	2.8	3.5	4.1	4.1	3.9
2400x1200	40	400	1.2	2.4	3.3	4.7	4.9	4.7
2400x1200	40	1000	1.1	2.2	3.7	5.5	5.6	5.3
1800x1200	40	200	0.6	2.0	2.9	3.4	3.3	3.1
1800x1200	40	400	0.8	1.9	2.6	3.7	3.7	3.6
1800x1200	40	1000	0.8	1.7	2.9	4.3	4.2	4.3
2400x600	40	200	0.5	1.4	2.0	2.4	2.3	2.3
2400x600	40	400	0.4	1.2	1.8	2.6	2.7	2.7
2400x600	40	1000	0.4	1.1	2.0	2.9	2.9	2.8
3000x1200	40	200	1.1	3.3	4.4	5.1	5.1	5.0
3000x1200	40	400	1.2	3.0	4.2	5.8	5.8	5.7
3000x1200	40	1000	1.1	2.8	4.8	6.8	6.8	6.7
1200x600	40	200	0.1	0.7	1.0	1.3	1.3	1.4
1200x600	40	400	0.2	0.5	0.9	1.4	1.5	1.6
1200x600	40	1000	0.1	0.5	0.9	1.6	1.6	1.6

Indoor Air Quality



Certificate / Label

Eurofins Indoor Air Comfort®

French VOC

IAC Gold

A+





Cradle to Cradle Certified®



This product is Cradle to Cradle Certified® at Bronze level (version 4.0).



Material Health

This product has received a C2C Certified Material Health Certificate™ at the Silver level (standard version 4.0). The C2C Certified Material Health Certificate™ is a verification of the health and safety of a product's composition using the Material Health requirements of the Cradle-to-Cradle Certified Product Standard.



Carbon footprint

	kg CO ₂ equiv/m ²	Life-cycle stages A1 to C4 from EPD, in conformity with ISO 14025 / EN 15804
Solo Rectangle	9,12	



Circularity

Minimum post-consumer recycled content	57%
Recyclability	Fully recyclable



Fire safety

Country	Fire standard	Class	The glass wool core of the tiles is tested and classified as non-combustible according to EN ISO 1182.
Europe	EN 13501-1	A2-s1,d0	



Humidity Resistance

Class C, relative humidity 95% and 30°C, according to EN 13964:2014



Visual appearance

White Frost, nearest NCS colour sample S 0500-N, 85% light reflectance. Gloss < 1.



Cleanability

Daily dusting and vacuum cleaning. Weekly wet wiping.



Accessibility

The tiles are demountable.



Installation

Installed according to installation diagrams, installation guides and drawing aid. For information regarding minimum overall depth of system see quantity specification.



System weight

	kg/m ²	Weight information is indicative and subject to variation.
Solo Rectangle	4,7	



Mechanical properties

The tile can take both point loads and distributed loads. See Functional demands, Mechanical properties at www.ecophon.com.



CE

Ecophon ceiling systems are CE marked according to the European harmonized standard EN 13964:2014. CE marked construction products are covered by a Declaration of Performance (DOP) which enables customers and users to easily compare performance of products available on the European market.

INSTALLATION DIAGRAM (M404) FOR ECOPHON SOLO RECTANGLE 1800X1200

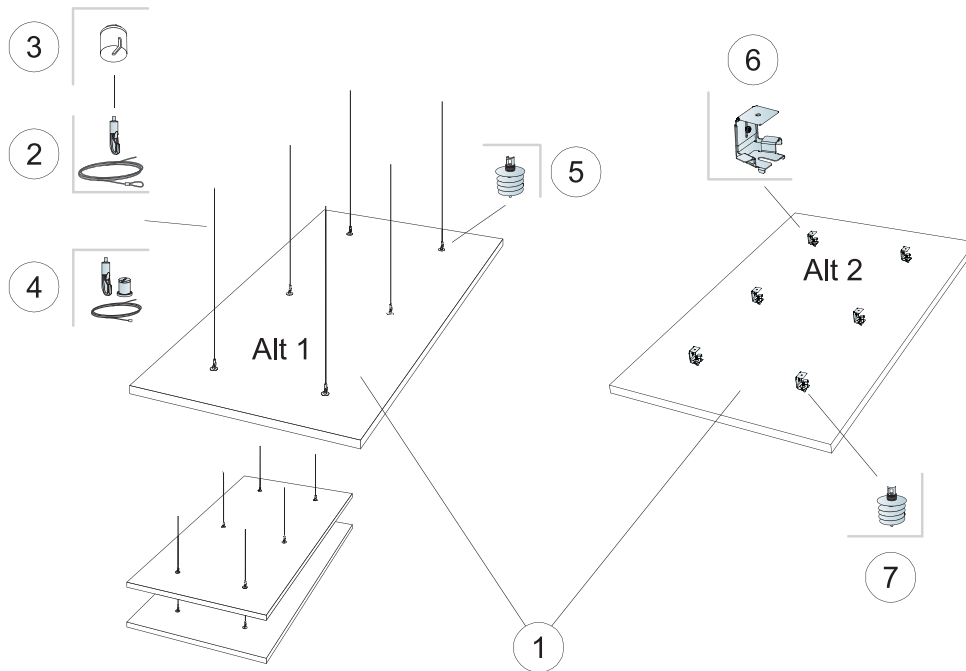

QUANTITY SPECIFICATION (EXCL. WASTAGE)

		Size, mm
		1800x1200
1	Solo Rectangle	2,16m ² /panel
2	Connect Adjustable wire hanger (Alt 1)	6/panel
3	Connect Covering cup (Alt 1, Optional)	6/panel
4	Connect Adjustable wire kit (Alt 1, Optional)	6/panel
5	Connect Absorber anchor (Alt 1)	6/panel
6	Connect Absorber bracket (Alt 2)	6/panel
7	Connect Absorber anchor (Alt 2)	6/panel
Δ Min. overall depth of system: Δ1 140 mm / Δ2 90 mm		-

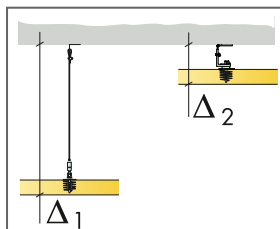

See Quantity specification

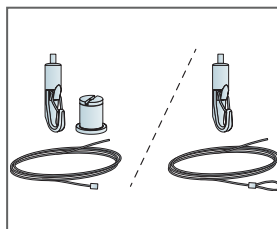

Two types of Adjustable wire solutions

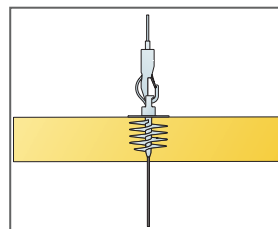

Panels can be suspended underneath each other

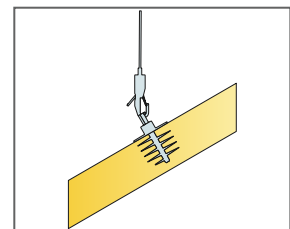

Panels can be installed in angles

INSTALLATION DIAGRAM (M405) FOR ECOPHON SOLO RECTANGLE 2400X600

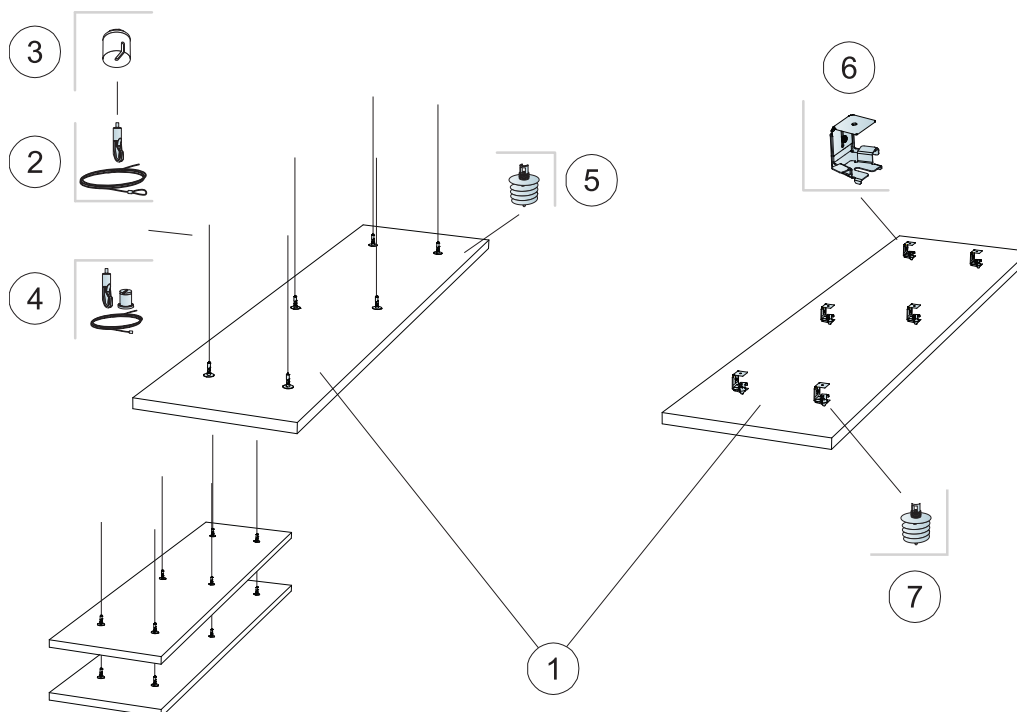

QUANTITY SPECIFICATION (EXCL. WASTAGE)

		Size, mm
		2400x600
1	Solo Rectangle	1,44m ² /panel
2	Connect Adjustable wire hanger (Alt 1)	6/panel
3	Connect Covering cup (Alt 1, Optional)	6/panel
4	Connect Adjustable wire kit (Alt 1, Optional)	6/panel
5	Connect Absorber anchor (Alt 1)	6/panel
6	Connect Absorber bracket (Alt 2)	6/panel
7	Connect Absorber anchor (Alt 2)	6/panel
Δ Min. overall depth of system: Δ1 140 mm / Δ2 90 mm		-

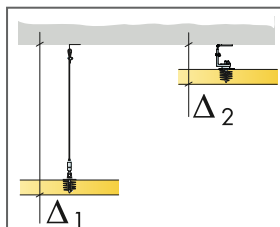

See Quantity specification

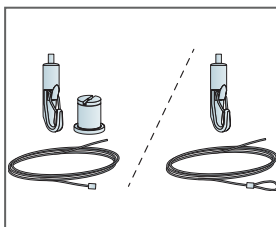

Two types of Adjustable wire solutions

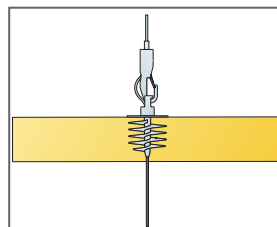

Panels can be suspended underneath each other

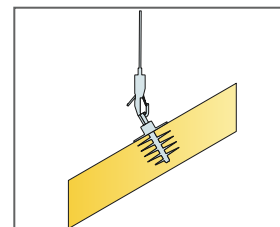

Panels can be installed in angles

INSTALLATION DIAGRAM (M406) FOR ECOPHON SOLO RECTANGLE 2400X1200

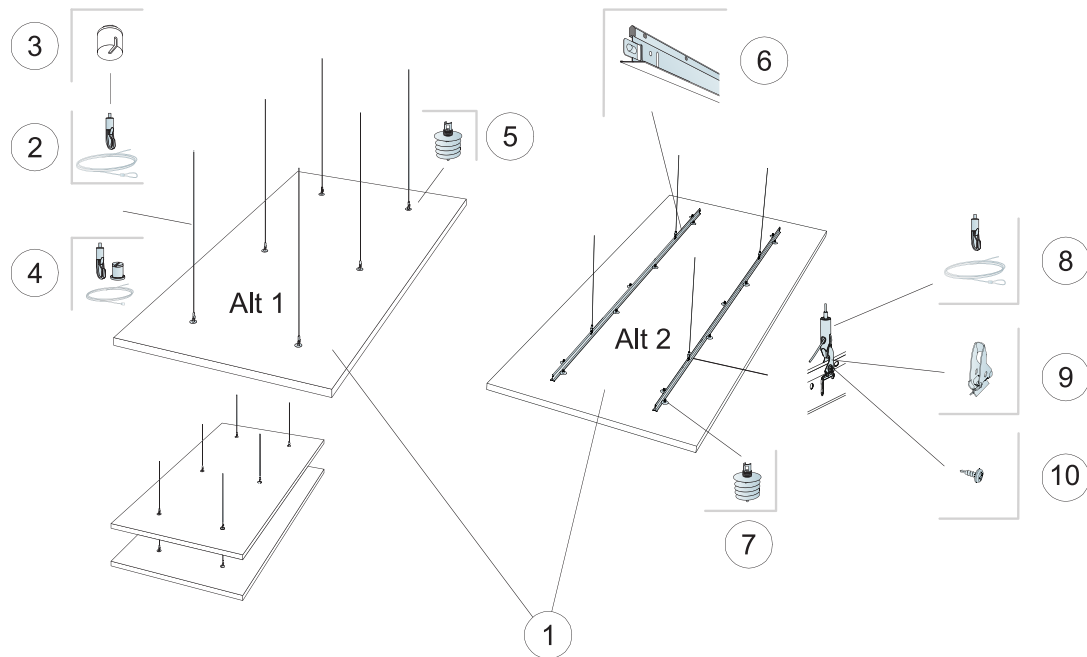

QUANTITY SPECIFICATION (EXCL. WASTAGE)

		Size, mm
		2400x1200
1	Solo Rectangle	2,88m ² /panel
2	Connect Adjustable wire hanger (Alt 1)	6/panel
3	Connect Covering cup (Alt 1, Optional)	6/panel
4	Connect Adjustable wire kit (Alt 1, Optional)	6/panel
5	Connect Absorber anchor (Alt 1)	6/panel
6	Connect T24 Main runner C3	2/panel
7	Connect Absorber anchor	14/panel
8	Connect Adjustable wire hanger	4/panel
9	Connect Adjustable wire hanger	4/panel
10	Connect Installation screw BR	4/panel
Δ Min. overall depth of system: Δ1 140 mm / Δ2 200 mm		-

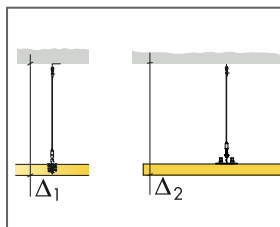

See Quantity specification

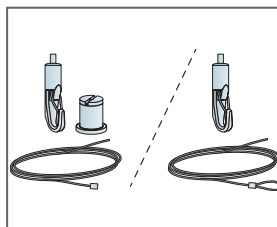

Two types of Adjustable wire solutions

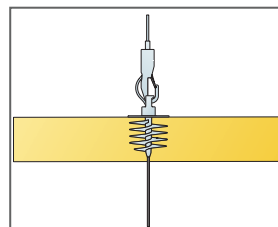

Panels can be suspended underneath each other

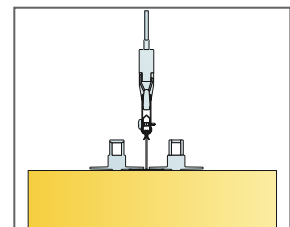

Panels can be suspended underneath each other

INSTALLATION DIAGRAM (M407) FOR ECOPHON SOLO RECTANGLE 2400X1200

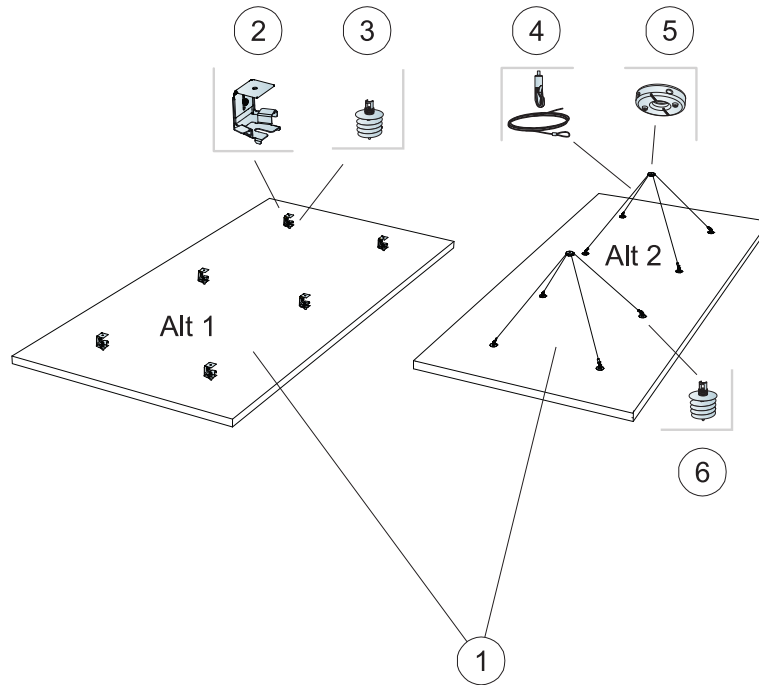

QUANTITY SPECIFICATION (EXCL. WASTAGE)

		Size, mm
		2400x1200
1	Solo Rectangle	2,88m ² /panel
2	Connect Absorber bracket (Alt 3)	6/panel
3	Connect Absorber anchor (Alt 3)	6/panel
4	Connect Adjustable wire hanger (Alt 2)	4/panel
5	Connect One-point fixing (Alt 2)	2/panel
6	Connect Absorber anchor (Alt 2)	8/panel
Δ Min. overall depth of system: Δ1 140 mm / Δ2 500 mm / Δ3 121 mm		-

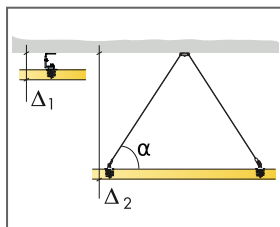

See Quantity specification

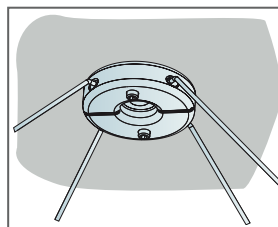

Detail of One-point fixing

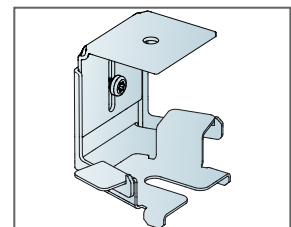

INSTALLATION DIAGRAM (M408) FOR ECOPHON SOLO RECTANGLE 3000X1200

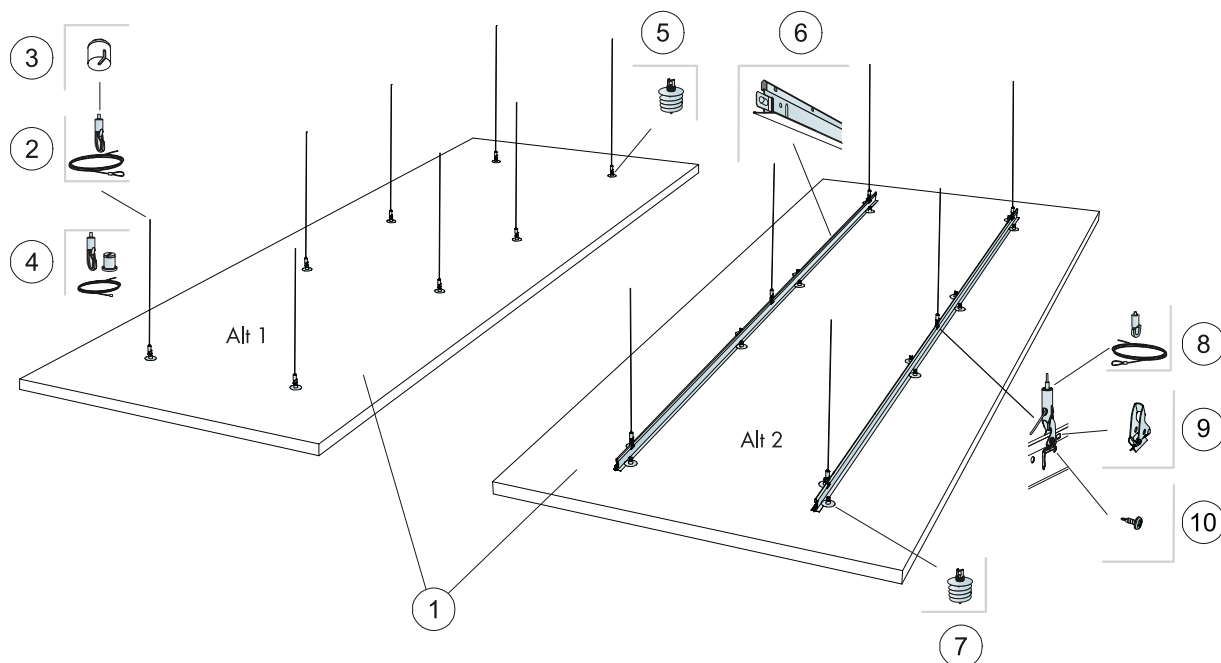

QUANTITY SPECIFICATION (EXCL. WASTAGE)

		Size, mm
		3000x1200
1	Solo Rectangle	3,6m ² /panel
2	Connect Adjustable wire hanger (Alt 1)	8/panel
3	Connect Covering cup (Alt 1, Optional)	8/panel
4	Connect Adjustable wire kit (Alt 1, Optional)	8/panel
5	Connect Absorber anchor (Alt 1)	8/panel
6	Connect T24 Main runner	2/panel
7	Connect Absorber anchor (Alt 2)	16/panel
8	Connect Adjustable wire hanger (Alt 2)	6/panel
9	Connect Adjustable wire hanger	6/panel
10	Connect Installation screw BR	6/panel
Δ Min. overall depth of system: Δ1 140 mm / Δ2 200 mm		-

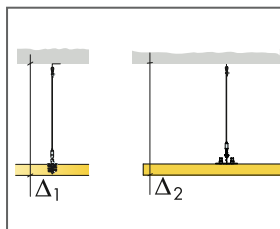

See Quantity specification

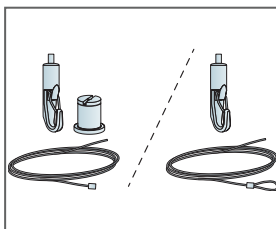

Two types of Adjustable wire solutions

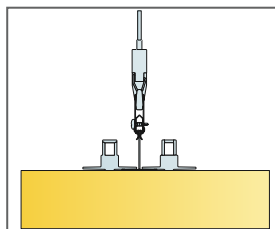

Panels can be suspended underneath each other

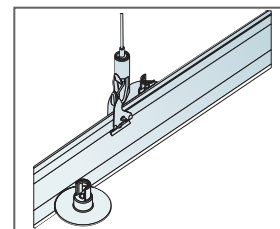

Panels can be suspended underneath each other

INSTALLATION DIAGRAM (M506) FOR ECOPHON SOLO RECTANGLE KIT

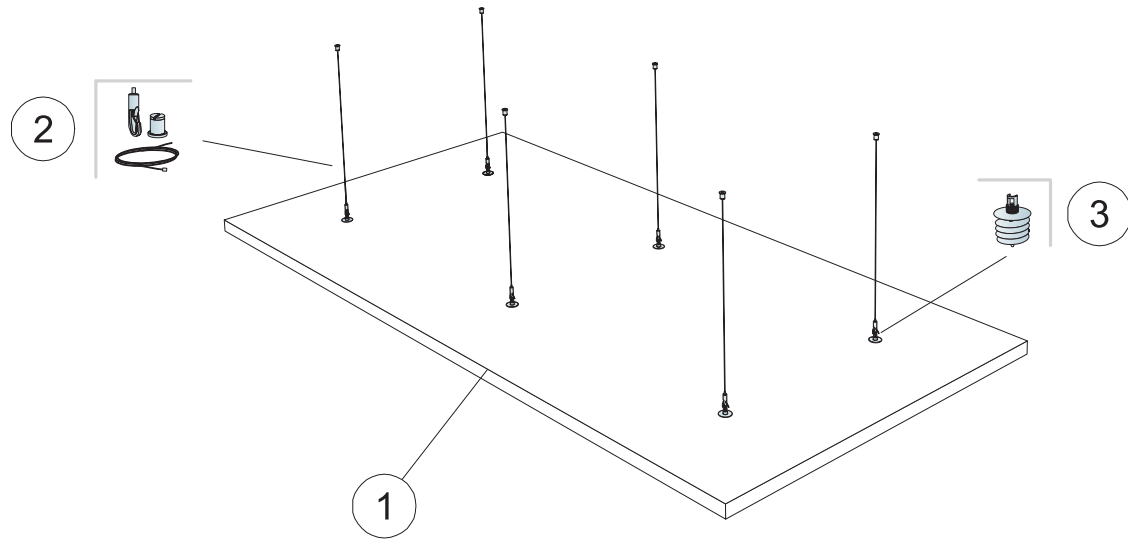

QUANTITY SPECIFICATION (EXCL. WASTAGE)

	Size, mm	
	1800x1200	2400x1200
1 Solo Rectangle Kit	2,16m ² /panel	2,88m ² /panel
2 Connect Adjustable wire kit 1500mm (included)	-	-
3 Connect Absorber anchor (included)	-	-
Δ Min. overall depth of system: Δ 140 mm	-	-
To install Connect Absorber Anchor, use Connect Absorber Anchor Bit.	-	-

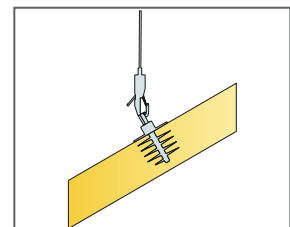
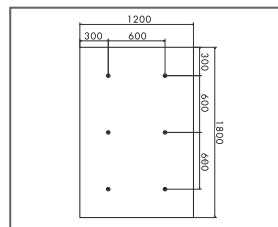
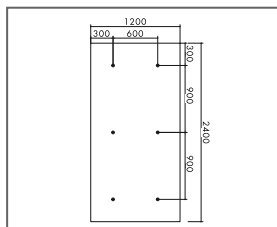
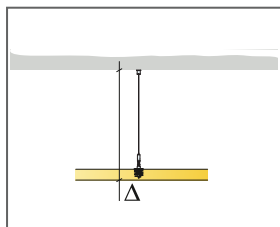

Panels can be installed in angles

INSTALLATION DIAGRAM (M637) FOR ECOPHON SOLO RECTANGLE

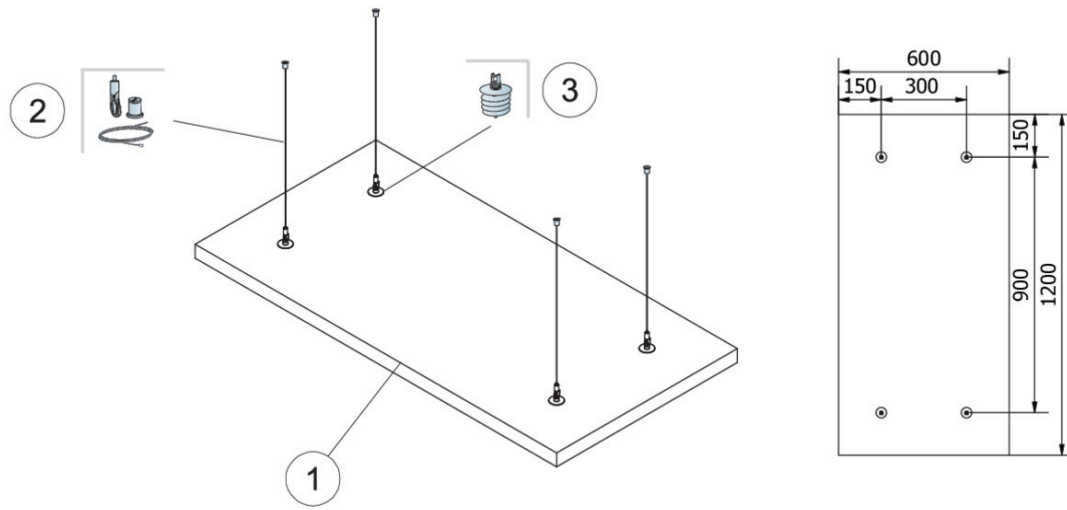

QUANTITY SPECIFICATION (EXCL. WASTAGE)

		Size, mm
		1200x600
1	Solo Rectangle	0,72m ² /panel
2	Connect Adjustable wire kit (Alt 1, Optional)	4/panel
3	Connect Absorber anchor (Alt 1)	4/panel
Δ Min. overall depth of system: Δ 140 mm		-
To install Connect Absorber Anchor, use Connect Absorber Anchor Bit.		-

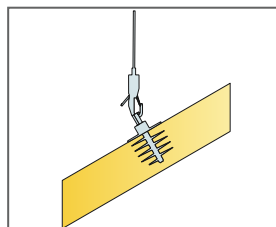
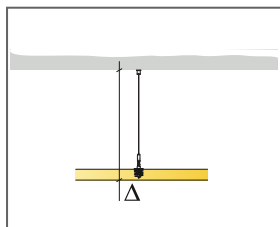

Panels can be installed in angles

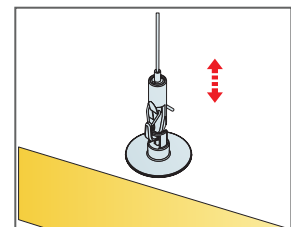

Easily adjustable suspension with Connect Adjustable wire hanger

Ecophon Solo™ Circle

Solo Circle is a free hanging unit, offering high level design possibilities. Three different suspension systems offer opportunities to create several layers and angles. Suitable when the room volume should be maintained or when it's not possible to install a wall-to-wall ceiling.



Asia Zereca, Warsaw, Poland

SYSTEM RANGE

 Size, mm	Ø800	Ø1200
Special Fixing	•	•
Thickness	40	40
Inst. Diagr.	M411	M410

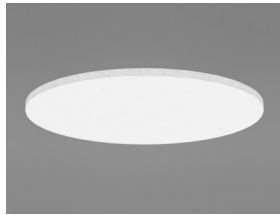

Solo Circle

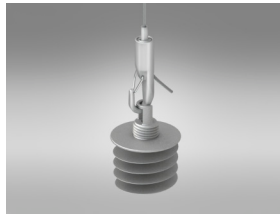

Suspension with Connect Adjustable wire hanger and Connect Absorber anchor



Suspension with Connect Adjustable wire hanger and Connect Absorber anchor

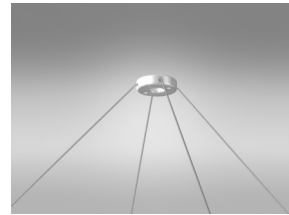

Suspension with One-point fixing anchor

Acoustic



The values in the diagram refer to a single unit. If the units are arranged in a cluster with distances between units less than 0,5 meters, the Aeq per unit will be slightly reduced.

Sound Absorption:

Test results according to EN ISO 354.

A_{anr} , Equivalent absorption area per unit (m² sabin)

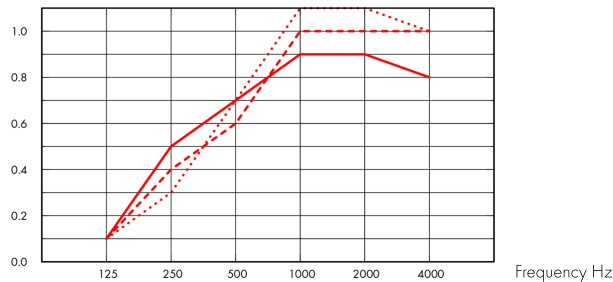

- Solo Circle Ø800, 200 mm o.d.s.
 - - - Solo Circle Ø800, 400 mm o.d.s.
 - ... Solo Circle Ø800, 1000 mm o.d.s.
- o.d.s = overall depth of system

A_{eq} , Equivalent absorption area per unit (m² sabin)

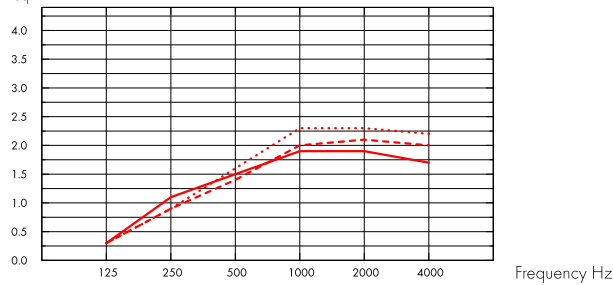

- Solo Circle Ø1200, 200 mm o.d.s.
 - - - Solo Circle Ø1200, 400 mm o.d.s.
 - ... Solo Circle Ø1200, 1000 mm o.d.s.
- o.d.s = overall depth of system

	THK mm	o.d.s. mm	A_{eq} , Equivalent absorption area per unit (m ² sabin)					
			125 Hz	250 Hz	500 Hz	1000 Hz	2000 Hz	4000 Hz
Ø800	40	200	0.1	0.5	0.7	0.9	0.9	0.8
Ø800	40	400	0.1	0.4	0.6	1.0	1.0	1.0
Ø800	40	1000	0.1	0.3	0.7	1.1	1.1	1.0

	THK mm	o.d.s. mm	A_{eq} , Equivalent absorption area per unit (m ² sabin)					
			125 Hz	250 Hz	500 Hz	1000 Hz	2000 Hz	4000 Hz
Ø1200	40	200	0.3	1.1	1.5	1.9	1.9	1.7
Ø1200	40	400	0.3	0.9	1.4	2.0	2.1	2.0
Ø1200	40	1000	0.3	0.9	1.6	2.3	2.3	2.2



Indoor Air Quality

Certificate / Label	
Eurofins Indoor Air Comfort®	IAC Gold
French VOC	A+



Cradle to Cradle Certified®



This product is Cradle to Cradle Certified® at Bronze level (version 4.0).



Material Health

This product has received a C2C Certified Material Health Certificate™ at the Silver level (standard version 4.0). The C2C Certified Material Health Certificate™ is a verification of the health and safety of a product's composition using the Material Health requirements of the Cradle-to-Cradle Certified Product Standard.



Carbon footprint

kg CO ₂ equiv/m ²		Life-cycle stages A1 to C4 from EPD, in conformity with ISO 14025 / EN 15804
Solo Circle	10,35	



Circularity

Minimum post-consumer recycled content	57%
Recyclability	Fully recyclable



Fire safety

Country	Fire standard	Class
Europe	EN 13501-1	A2-s1,d0

The glass wool core of the tiles is tested and classified as non-combustible according to EN ISO 1182.



Humidity Resistance

Class C, relative humidity 95% and 30°C, according to EN 13964:2014



Visual appearance

White Frost, nearest NCS colour sample S 0500-N, 85% light reflectance. Gloss < 1.



Cleanability

Daily dusting and vacuum cleaning. Weekly wet wiping.



Accessibility

The tiles are demountable.



Installation

Installed according to installation diagrams, installation guides and drawing aid. For information regarding minimum overall depth of system see quantity specification.



System weight

	kg/m ²	Weight information is indicative and subject to variation.
Solo Circle	4,6	



Mechanical properties

The tile can take both point loads and distributed loads. See Functional demands, Mechanical properties at www.ecophon.com.



CE

Ecophon ceiling systems are CE marked according to the European harmonized standard EN 13964:2014. CE marked construction products are covered by a Declaration of Performance (DOP) which enables customers and users to easily compare performance of products available on the European market.

INSTALLATION DIAGRAM (M410) FOR ECOPHON SOLO CIRCLE

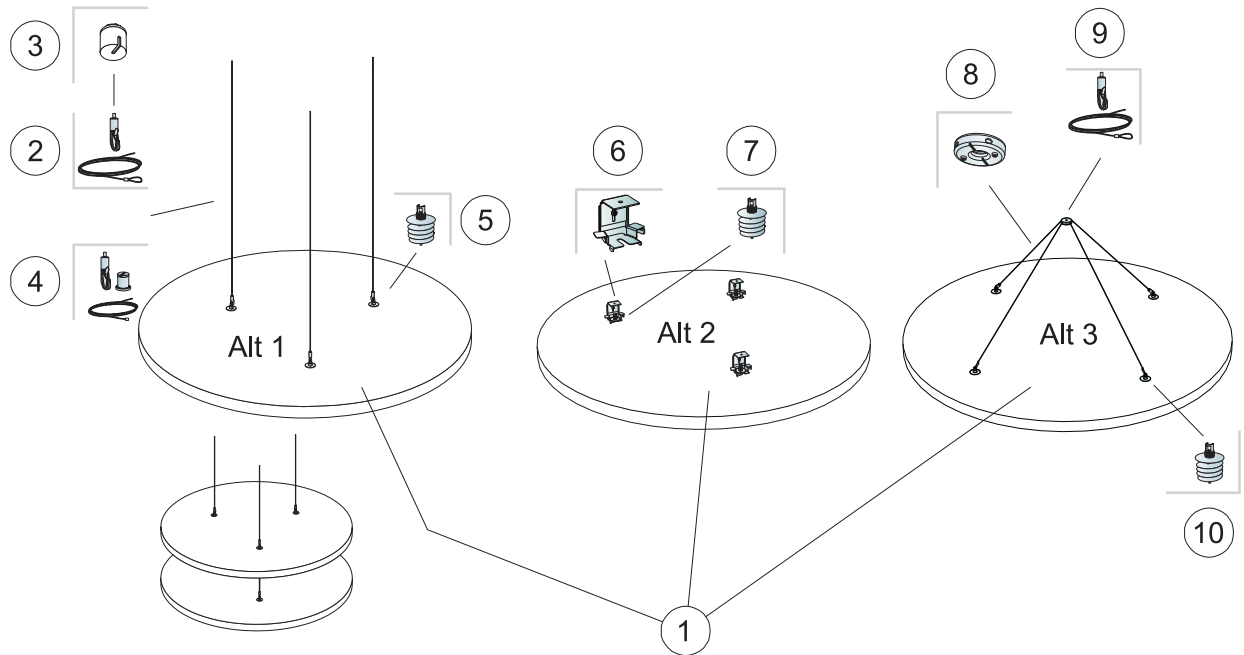

QUANTITY SPECIFICATION (EXCL. WASTAGE)

		Size, mm
		Ø1200
1	Solo Circle	1,13m ² /panel
2	Connect Adjustable wire hanger (Alt 1)	3/panel
3	Connect Covering cup (Alt 1, Optional)	3/panel
4	Connect Adjustable wire Kit (Alt 1, Optional)	3/panel
5	Connect Absorber anchor (Alt 1)	3/panel
6	Connect Absorber bracket (Alt 2)	3/panel
7	Connect Absorber anchor (Alt 2)	3/panel
8	Connect One-point fixing (Alt 3)	1/panel
9	Connect Adjustable wire hanger (Alt 3)	2/panel
10	Connect Absorber anchor (Alt 3)	4/panel
Δ Min. overall depth of system: Δ1 140 mm / Δ2 90 mm / Δ3 500 mm		-

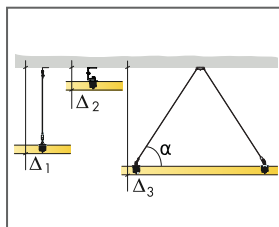

See Quantity specification

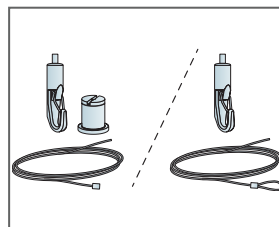

Two types of Adjustable wire solutions

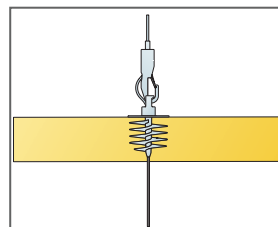

Panels can be suspended underneath each other

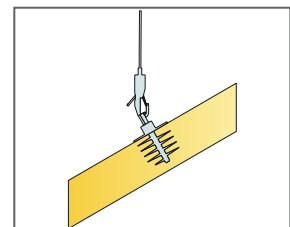

Panels can be installed in angles

INSTALLATION DIAGRAM (M411) FOR ECOPHON SOLO CIRCLE

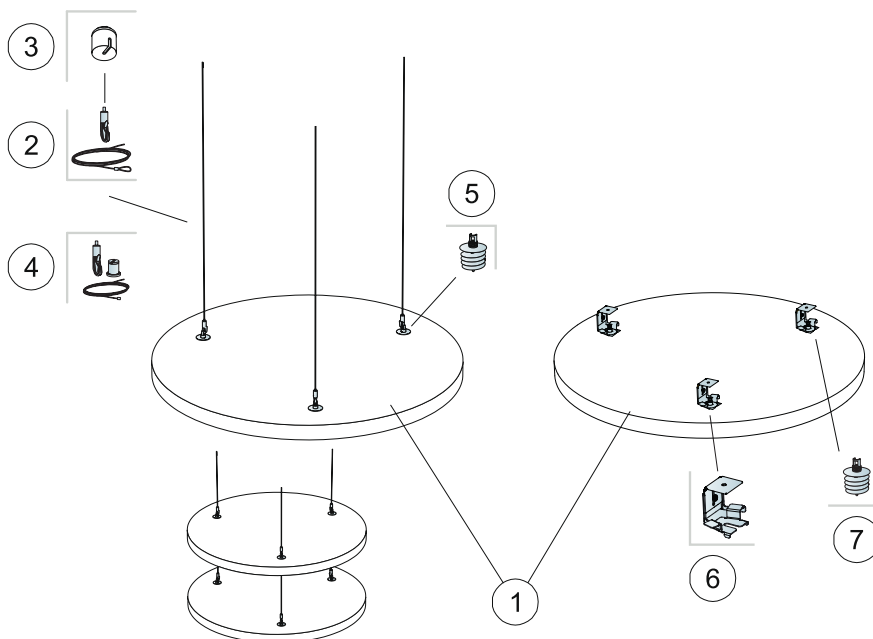

QUANTITY SPECIFICATION (EXCL. WASTAGE)

		Size, mm
		Ø800
1	Solo Circle	0,5m ² /panel
2	Connect Adjustable wire hanger (Alt 1)	3/panel
3	Connect Covering cup (Alt 1, Optional)	3/panel
4	Connect Adjustable wire Kit (Alt 1, Optional)	3/panel
5	Connect Absorber anchor (Alt 1)	3/panel
6	Connect Absorber bracket (Alt 2)	3/panel
7	Connect Absorber anchor (Alt 2)	3/panel
Δ Min. overall depth of system: Δ1 140 mm / Δ2 90 mm		-

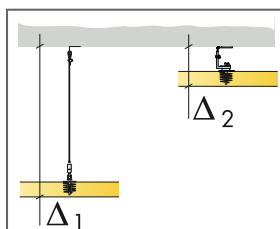

See Quantity specification

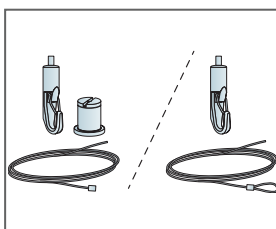

Two types of Adjustable wire solutions

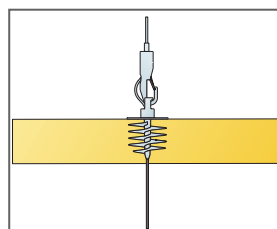

Panels can be suspended underneath each other

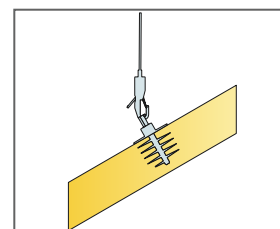

Panels can be installed in angles

Ecophon Solo™ Circle XL

Solo Circle XL is a large free hanging unit with two semicircles, offering a high degree of design possibilities. For applications when it is not possible to install a wall-to-wall ceiling



YOO Communications AG, St. Gallen, Switzerland

SYSTEM RANGE



Size, mm	XL Ø1600
Special Fixing	•
Thickness	40
Inst. Diagr.	M290

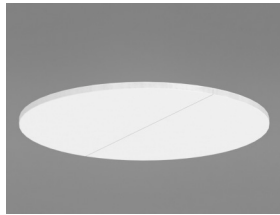

Solo Circle XL

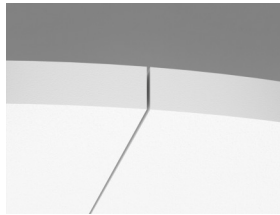

Solo Circle XL tile

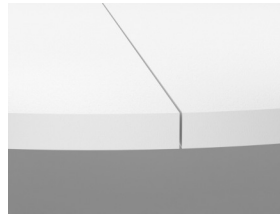

Rear side of Solo Circle XL

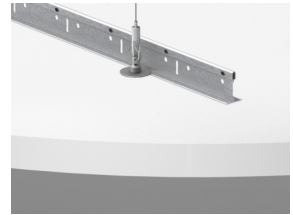

Solo Circle XL installation with Connect Absorber anchor

Acoustic



The values in the diagram refer to a single unit. If the units are arranged in a cluster with distances between units less than 0,5 meters, the Aeq per unit will be slightly reduced.

Sound Absorption:

Test results according to EN ISO 354.

A_{eq}: Equivalent absorption area per unit (m² sabin)

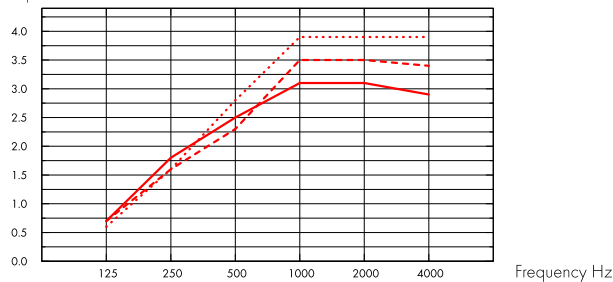

- Solo Circle XL, 200 mm o.d.s.
 - - - Solo Circle XL, 400 mm o.d.s.
 - ... Solo Circle XL, 1000 mm o.d.s.
- o.d.s = overall depth of system

THK mm	o.d.s. mm	A _{eq} : Equivalent absorption area per unit (m ² sabin)					
		125 Hz	250 Hz	500 Hz	1000 Hz	2000 Hz	4000 Hz
40	200	0.7	1.8	2.5	3.1	3.1	2.9
40	400	0.7	1.6	2.3	3.5	3.5	3.4
40	1000	0.6	1.6	2.8	3.9	3.9	3.9

Indoor Air Quality



Certificate / Label

Eurofins Indoor Air Comfort®

IAC Gold

French VOC

A+



Cradle to Cradle Certified®



This product is Cradle to Cradle Certified® at Bronze level (version 4.0).



Material Health

This product has received a C2C Certified Material Health Certificate™ at the Silver level (standard version 4.0). The C2C Certified Material Health Certificate™ is a verification of the health and safety of a product's composition using the Material Health requirements of the Cradle-to-Cradle Certified Product Standard.



Carbon footprint

	kg CO ₂ equiv/m ²
Solo Circle	10,35

Life-cycle stages A1 to C4 from EPD, in conformity with ISO 14025 / EN 15804



Circularity

Minimum post-consumer recycled content	57%
Recyclability	Fully recyclable



Fire safety

Country	Fire standard	Class
Europe	EN 13501-1	A2-s1,d0

The glass wool core of the tiles is tested and classified as non-combustible according to EN ISO 1182.



Humidity Resistance

Class C, relative humidity 95% and 30°C, according to EN 13964:2014



Visual appearance

White Frost, nearest NCS colour sample S 0500-N, 85% light reflectance. Gloss < 1.



Cleanability

Daily dusting and vacuum cleaning. Weekly wet wiping.



Accessibility

The tiles are demountable.



Installation

Installed according to installation diagrams, installation guides and drawing aid. For information regarding minimum overall depth of system see quantity specification.



System weight

	kg/m ²
Solo Circle XL	4,8

Weight information is indicative and subject to variation.



Mechanical properties

No additional live load is allowed.



CE

Ecophon ceiling systems are CE marked according to the European harmonized standard EN13964:2014. CE marked construction products are covered by a Declaration of Performance (DOP) which enables customers and users to easily compare performance of products available on the European market.

INSTALLATION DIAGRAM (M290) FOR ECOPHON SOLO CIRCLE XL

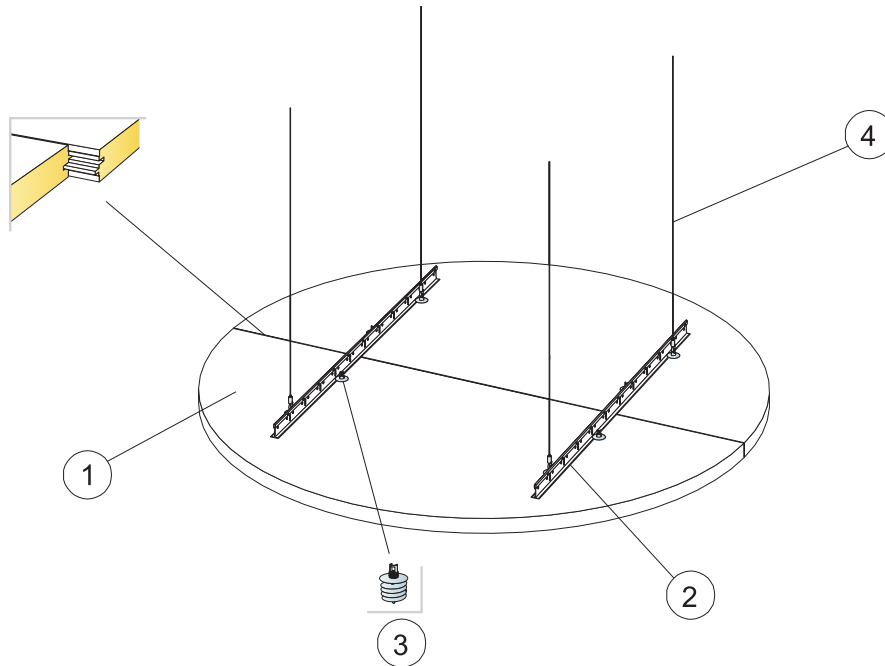

© Ecophon Group

QUANTITY SPECIFICATION (EXCL. WASTAGE)

		Size, mm
		Ø1600
1	Solo Circle XL	2,01 m ² /panel
2	Connect T24 Main runner	0,60/panel
3	Connect Absorber anchor	8/panel
4	Connect Adjustable wire hanger	4/panel
Δ Min. overall depth of system: Δ 200 mm		-
To install Connect Absorber Anchor, use Connect Absorber Anchor Bit.		-

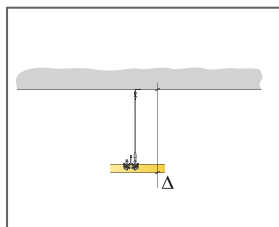

See Quantity specification

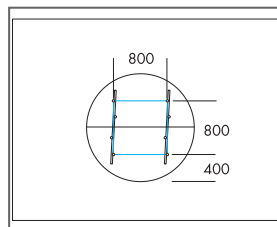

Suspension with Connect Adjustable wire hangers and Connect T24 Main runner

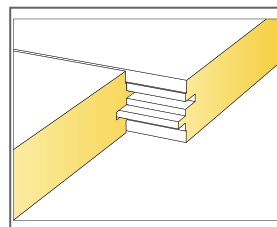

Meeting between panels

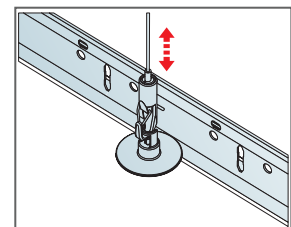

Easily adjustable suspension with Connect Adjustable wire hanger

Ecophon Solo™ Cloud

Solo Cloud is a free-hanging unit, offering high level design possibilities. Three different suspension systems offer opportunities to create several layers and angles. Suitable when the room volume should be maintained or when it's not possible to install a wall-to-wall ceiling.



SYSTEM RANGE



Size, mm	1200x553	2400x1106
Special Fixing	•	•
Thickness	40	40
Inst. Diagr.	M430	M430

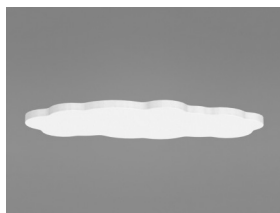

Acoustic panel Solo Freedom in cloud shape



Suspension with Connect Adjustable wire hanger and Connect Absorber anchor

Acoustic



For acoustic data on the panel - please see Solo Rectangle.



Cradle to Cradle Certified®



This product is Cradle to Cradle Certified® at Bronze level (version 4.0).



Material Health

This product has received a C2C Certified Material Health Certificate™ at the Silver level (standard version 4.0). The C2C Certified Material Health Certificate™ is a verification of the health and safety of a product's composition using the Material Health requirements of the Cradle-to-Cradle Certified Product Standard.



Carbon footprint

	kg CO ₂ equiv/m ²	Life-cycle stages A1 to C4 from EPD, in conformity with ISO 14025 / EN 15804
Solo Freedom	8,41 (Solo Family EPD in conformity with ISO 14025 / EN 15804)	



Circularity

Minimum post-consumer recycled content	57%
Recyclability	Fully recyclable



Fire safety

Country	Fire standard	Class	The glass wool core of the tiles is tested and classified as non-combustible according to EN ISO 1182.
Europe	EN 13501-1	A2-s1,d0	



Humidity Resistance

Class C, relative humidity 95% and 30°C, according to EN 13964:2014



Visual appearance

White Frost, nearest NCS colour sample S 0500-N, 85% light reflectance. Gloss < 1.



Cleanability

Daily dusting and vacuum cleaning. Weekly wet wiping.



Accessibility

The tiles are demountable.



Installation

Installed according to installation diagrams, installation guides and drawing aid. For information regarding minimum overall depth of system see quantity specification.



Mechanical properties

The tile can take both point loads and distributed loads. See Functional demands, Mechanical properties at www.ecophon.com.



CE

Ecophon ceiling systems are CE marked according to the European harmonized standard EN 13964:2014. CE marked construction products are covered by a Declaration of Performance (DOP) which enables customers and users to easily compare performance of products available on the European market.

INSTALLATION DIAGRAM (M412) FOR ECOPHON SOLO FREEDOM

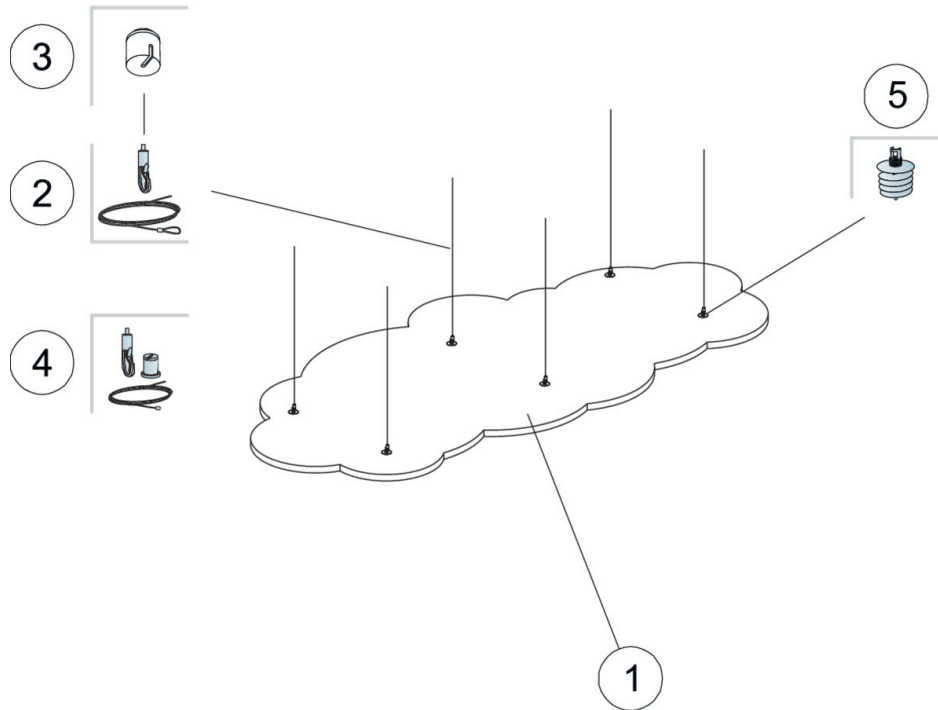

QUANTITY SPECIFICATION (EXCL. WASTAGE)

		Size, mm	
		1200x553	2400x1106
1	Solo Freedom	-	-
2	Connect Adjustable wire hanger (Alt 1)	-	-
3	Connect Covering cup (Alt 1, Optional)	-	-
4	Connect Adjustable wire kit (Alt 1, Optional)	-	-
5	Connect Absorber anchor	-	-
Δ Min. overall depth of system: 140 mm		-	-

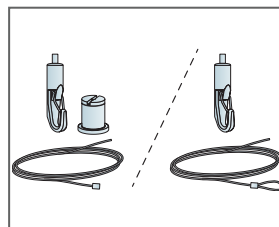

Two types of Adjustable wire solutions

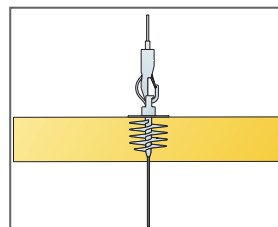

Panels can be suspended underneath each other

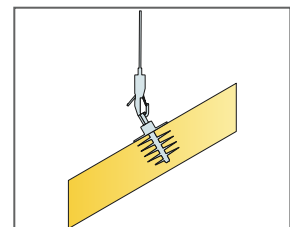

Panels can be installed in angles

Ecophon Solo™ Ellipse

Solo Ellipse is a free-hanging unit, offering high level design possibilities. Three different suspension systems offer opportunities to create several layers and angles. Suitable when the room volume should be maintained or when it's not possible to install a wall-to-wall ceiling.



Chelamco Arena, Belgium

SYSTEM RANGE



Size, mm	2400x1000
Special Fixing	•
Thickness	40
Inst. Diagr.	M428

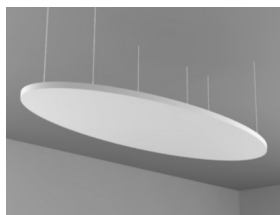

Suspension with Connect Adjustable wire hanger and Connect Absorber anchor

Acoustic



The values in the diagram refer to a single unit. If the units are arranged in a cluster with distances between units less than 0,5 meters, the Aeq per unit will be slightly reduced.

Sound Absorption:

Based on test results according to EN ISO 354.

A_{eq} Equivalent absorption area per unit (m² sabin)

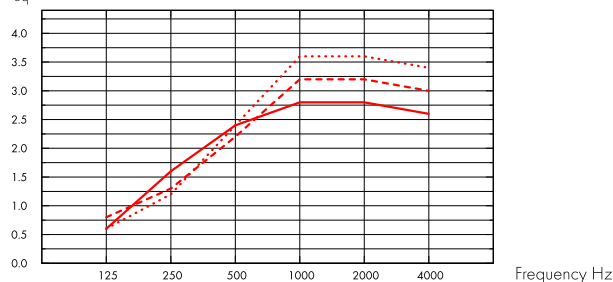

- Solo Ellipse 2400x1000, 200 mm o.d.s.
 - - - Solo Ellipse 2400x1000, 400 mm o.d.s.
 - ... Solo Ellipse 2400x1000, 1000 mm o.d.s.
- o.d.s = overall depth of system

THK mm	o.d.s. mm	A_{eq} Equivalent absorption area per unit (m ² sabin)					
		125 Hz	250 Hz	500 Hz	1000 Hz	2000 Hz	4000 Hz
40	200	0.6	1.6	2.4	2.8	2.8	2.6
40	400	0.8	1.3	2.2	3.2	3.2	3.0
40	1000	0.6	1.2	2.4	3.6	3.6	3.4

Indoor Air Quality



Certificate / Label

Eurofins Indoor Air Comfort®

IAC Gold

French VOC

A+



Cradle to Cradle Certified®



This product is Cradle to Cradle Certified® at Bronze level (version 4.0).



Material Health

This product has received a C2C Certified Material Health Certificate™ at the Silver level (standard version 4.0). The C2C Certified Material Health Certificate™ is a verification of the health and safety of a product's composition using the Material Health requirements of the Cradle-to-Cradle Certified Product Standard.



Carbon footprint

kg CO ₂ equiv/m ²		Life-cycle stages A1 to C4 from EPD, in conformity with ISO 14025 / EN 15804
Solo Freedom	8,41 (Solo Family EPD in conformity with ISO 14025 / EN 15804)	



Circularity

Minimum post-consumer recycled content	57%
Recyclability	Fully recyclable



Fire safety

Country	Fire standard	Class	The glass wool core of the tiles is tested and classified as non-combustible according to EN ISO 1182.
Europe	EN 13501-1	A2-s1,d0	



Humidity Resistance

Class C, relative humidity 95% and 30°C, according to EN 13964:2014



Visual appearance

White Frost, nearest NCS colour sample S 0500-N, 85% light reflectance. Gloss < 1.



Cleanability

Daily dusting and vacuum cleaning. Weekly wet wiping.



Accessibility

The tiles are demountable.



Installation

Installed according to installation diagrams, installation guides and drawing aid. For information regarding minimum overall depth of system see quantity specification.



System weight

kg/m ²		Weight information is indicative and subject to variation.
Solo Ellipse	4,8	



Mechanical properties

The tile can take both point loads and distributed loads. See Functional demands, Mechanical properties at www.ecophon.com.



CE

Ecophon ceiling systems are CE marked according to the European harmonized standard EN 13964:2014. CE marked construction products are covered by a Declaration of Performance (DOP) which enables customers and users to easily compare performance of products available on the European market.

INSTALLATION DIAGRAM (M428) FOR ECOPHON SOLO ELLIPSE

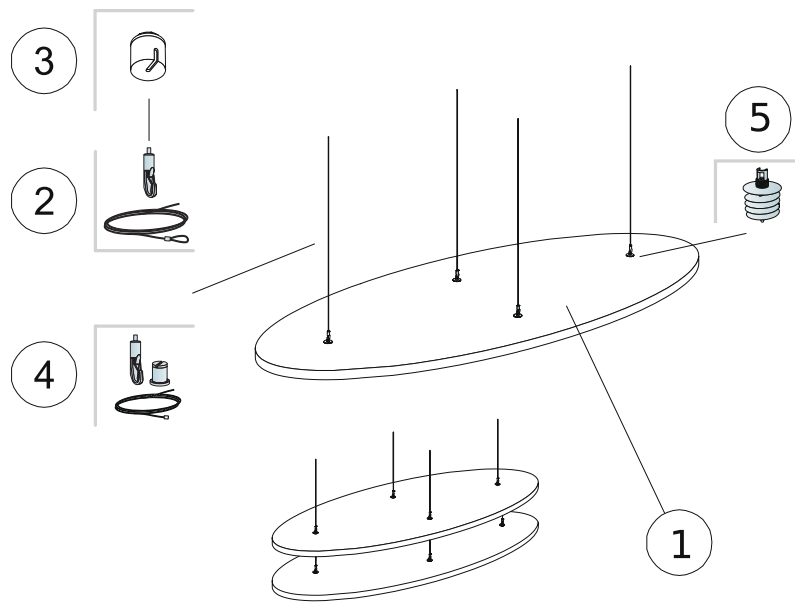

QUANTITY SPECIFICATION (EXCL. WASTAGE)

		Size, mm
		2400x1000
1	Solo Ellipse	1,89m ² /panel
2	Connect Adjustable wire hanger (Alt 1)	4/panel
3	Connect Covering cup (Alt 1, Optional)	4/panel
4	Connect Adjustable wire kit (Alt 1, Optional)	4/panel
5	Connect Absorber anchor (Alt 1)	4/panel
Δ Min. overall depth of system: 140 mm		-
To install Connect Absorber Anchor, use Connect Absorber Anchor Bit.		-

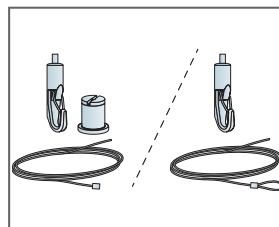
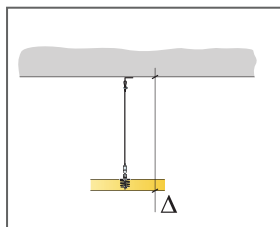

Two types of Adjustable wire solutions

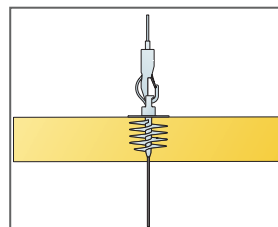

Panels can be suspended underneath each other

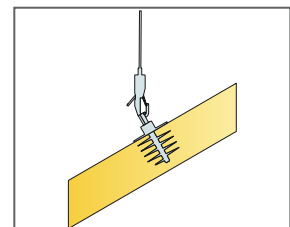

Panels can be installed in angles

Ecophon Solo™ Triangle

Solo Triangle is a free-hanging unit, offering high level design possibilities. Three different suspension systems offer opportunities to create several layers and angles. Suitable when the room volume should be maintained or when it's not possible to install a wall-to-wall ceiling.



Ghelamco Arena, Belgium

SYSTEM RANGE



Size, mm	1039x1200
Special Fixing	•
Thickness	40
Inst. Diag.	M297

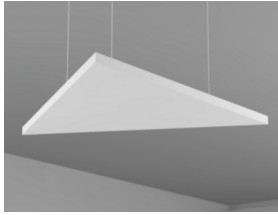

Suspension with Connect Adjustable wire hanger and Connect Absorber anchor

Acoustic



The values in the diagram refer to a single unit. If the units are arranged in a cluster with distances between units less than 0,5 meters, the Aeq per unit will be slightly reduced.

Sound Absorption:

Based on test results according to EN ISO 354.

A_{eq} Equivalent absorption area per unit (m² sabin)

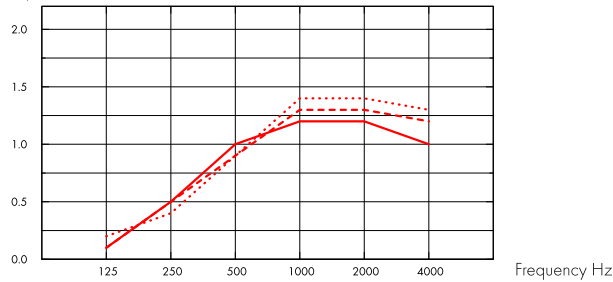

- Solo Triangle 1039x1200, 200 mm o.d.s.
 - - - Solo Triangle 1039x1200, 400 mm o.d.s.
 - ... Solo Triangle 1039x1200, 1000 mm o.d.s.
- o.d.s = overall depth of system

THK mm	o.d.s. mm	A _{eq} Equivalent absorption area per unit (m ² sabin)					
		125 Hz	250 Hz	500 Hz	1000 Hz	2000 Hz	4000 Hz
40	200	0.1	0.5	1.0	1.2	1.2	1.0
40	400	0.1	0.5	0.9	1.3	1.3	1.2
40	1000	0.2	0.4	0.9	1.4	1.4	1.3

Indoor Air Quality



Certificate / Label

Eurofins Indoor Air Comfort®

IAC Gold

French VOC

A+



Cradle to Cradle Certified®



This product is Cradle to Cradle Certified® at Bronze level (version 4.0).



Material Health

This product has received a C2C Certified Material Health Certificate™ at the Silver level (standard version 4.0). The C2C Certified Material Health Certificate™ is a verification of the health and safety of a product's composition using the Material Health requirements of the Cradle-to-Cradle Certified Product Standard.



Carbon footprint

kg CO ₂ equiv/m ²		Life-cycle stages A1 to C4 from EPD, in conformity with ISO 14025 / EN 15804
Solo Freedom	8,41 (Solo Family EPD in conformity with ISO 14025 / EN 15804)	



Circularity

Minimum post-consumer recycled content	57%
Recyclability	Fully recyclable



Fire safety

Country	Fire standard	Class	The glass wool core of the tiles is tested and classified as non-combustible according to EN ISO 1182.
Europe	EN 13501-1	A2-s1,d0	



Humidity Resistance

Class C, relative humidity 95% and 30°C, according to EN 13964:2014



Visual appearance

White Frost, nearest NCS colour sample S 0500-N, 85% light reflectance. Gloss < 1.



Cleanability

Daily dusting and vacuum cleaning. Weekly wet wiping.



Accessibility

The tiles are demountable.



Installation

Installed according to installation diagrams, installation guides and drawing aid. For information regarding minimum overall depth of system see quantity specification.



System weight

kg/m ²		Weight information is indicative and subject to variation.
Solo Triangle	4,7	



Mechanical properties

The tile can take both point loads and distributed loads. See Functional demands, Mechanical properties at www.ecophon.com.



CE

Ecophon ceiling systems are CE marked according to the European harmonized standard EN13964:2014. CE marked construction products are covered by a Declaration of Performance (DOP) which enables customers and users to easily compare performance of products available on the European market.

INSTALLATION DIAGRAM (M297) FOR ECOPHON SOLO TRIANGLE

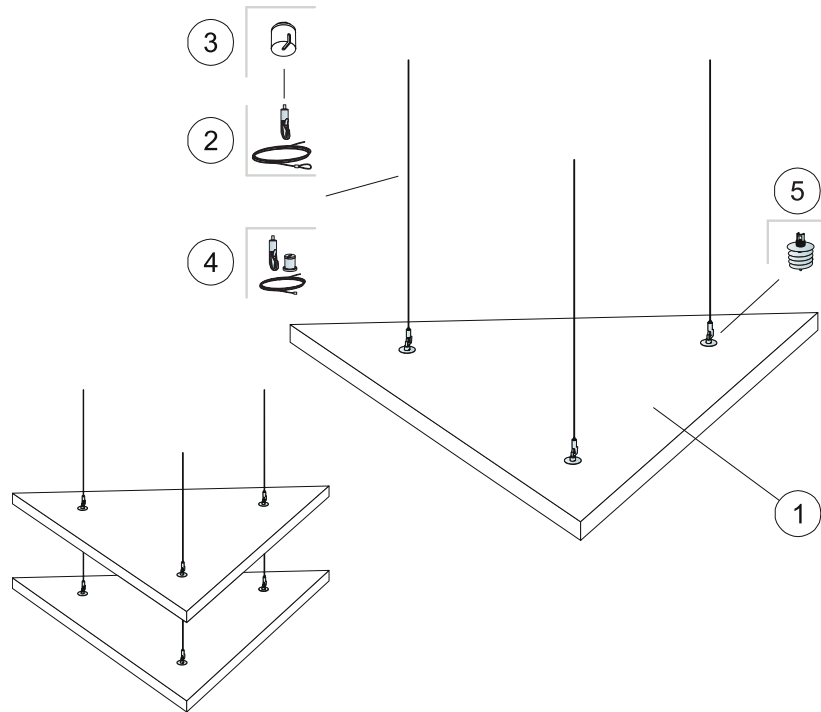

QUANTITY SPECIFICATION (EXCL. WASTAGE)

		Size, mm
		1039x1200
1	Solo Triangle	0,62m ² /panel
2	Connect Adjustable wire hanger (Alt 1)	3/panel
3	Connect Covering cup (Alt 1, Optional)	3/panel
4	Connect Adjustable wire Kit (Alt 1, Optional)	3/panel
5	Connect Absorber anchor	3/panel
Δ Min. overall depth of system: 140 mm		-
To install Connect Absorber Anchor, use Connect Absorber Anchor Bit.		-

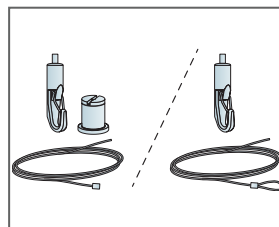

Two types of Adjustable wire solutions

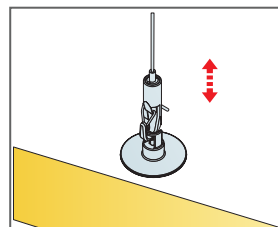

Easily adjustable suspension with Connect Adjustable wire hanger

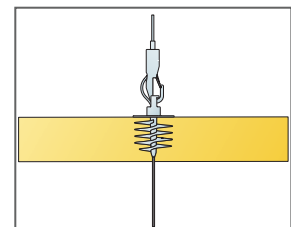

Panels can be suspended underneath each other

Ecophon Solo™ Pentagon

Solo Pentagon is a free-hanging unit, offering high level design possibilities. Three different suspension systems offer opportunities to create several layers and angles. Suitable when the room volume should be maintained or when it's not possible to install a wall-to-wall ceiling.



Ghelamco Arena, Belgium

SYSTEM RANGE



Size, mm	1139x1198
Special Fixing	•
Thickness	40
Inst. Diagr.	M427

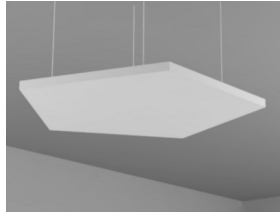

Acoustic panel Solo Freedom in cloud shape

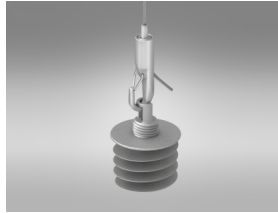

Suspension with Connect Adjustable wire hanger and Connect Absorber anchor

Acoustic



The values in the diagram refer to a single unit. If the units are arranged in a cluster with distances between units less than 0,5 meters, the Aeq per unit will be slightly reduced.

Sound Absorption:

Based on test results according to EN ISO 354.

A_{eq} Equivalent absorption area per unit (m² sabin)

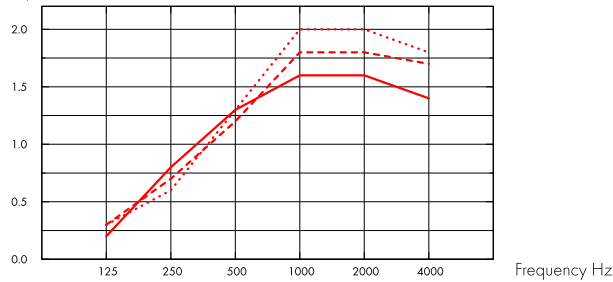

- Solo Pentagon 1139x1198, 200 mm o.d.s.
 - - - Solo Pentagon 1139x1198, 400 mm o.d.s.
 - ... Solo Pentagon 1139x1198, 1000 mm o.d.s.
- o.d.s = overall depth of system

THK mm	o.d.s. mm	A_{eq} Equivalent absorption area per unit (m ² sabin)					
		125 Hz	250 Hz	500 Hz	1000 Hz	2000 Hz	4000 Hz
40	200	0.2	0.8	1.3	1.6	1.6	1.4
40	400	0.3	0.7	1.2	1.8	1.8	1.7
40	1000	0.3	0.6	1.3	2.0	2.0	1.8

Indoor Air Quality



Certificate / Label

Eurofins Indoor Air Comfort®

IAC Gold

French VOC

A+



Cradle to Cradle Certified®



This product is Cradle to Cradle Certified® at Bronze level (version 4.0).



Material Health

This product has received a C2C Certified Material Health Certificate™ at the Silver level (standard version 4.0). The C2C Certified Material Health Certificate™ is a verification of the health and safety of a product's composition using the Material Health requirements of the Cradle-to-Cradle Certified Product Standard.



Carbon footprint

kg CO ₂ equiv/m ²		Life-cycle stages A1 to C4 from EPD, in conformity with ISO 14025 / EN 15804
Solo Freedom	8,41 (Solo Family EPD in conformity with ISO 14025 / EN 15804)	



Circularity

Minimum post-consumer recycled content	57%
Recyclability	Fully recyclable



Fire safety

Country	Fire standard	Class	The glass wool core of the tiles is tested and classified as non-combustible according to EN ISO 1182.
Europe	EN 13501-1	A2-s1,d0	



Humidity Resistance

Class C, relative humidity 95% and 30°C, according to EN 13964:2014



Visual appearance

White Frost, nearest NCS colour sample S 0500-N, 85% light reflectance. Gloss < 1.



Cleanability

Daily dusting and vacuum cleaning. Weekly wet wiping.



Accessibility

The tiles are demountable.



Installation

Installed according to installation diagrams, installation guides and drawing aid. For information regarding minimum overall depth of system see quantity specification.



System weight

kg/m ²		Weight information is indicative and subject to variation.
Solo Pentagon	4,7	



Mechanical properties

The tile can take both point loads and distributed loads. See Functional demands, Mechanical properties at www.ecophon.com.



CE

Ecophon ceiling systems are CE marked according to the European harmonized standard EN13964:2014. CE marked construction products are covered by a Declaration of Performance (DOP) which enables customers and users to easily compare performance of products available on the European market.

INSTALLATION DIAGRAM (M427) FOR ECOPHON SOLO PENTAGON

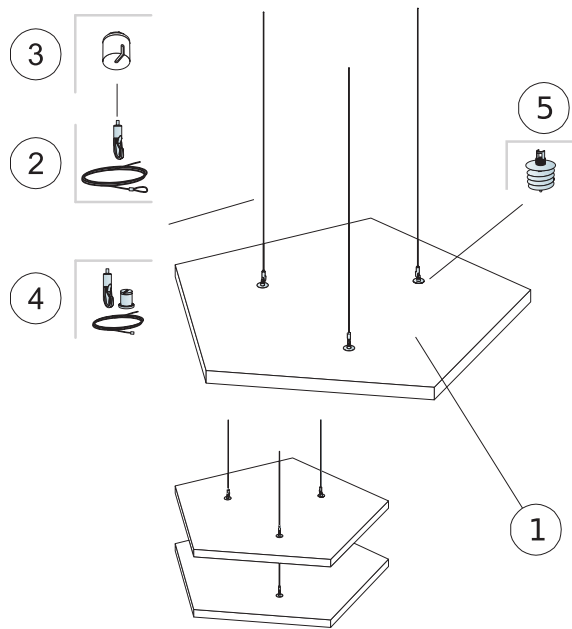

QUANTITY SPECIFICATION (EXCL. WASTAGE)

		Size, mm
		1139x1198
1	Solo Pentagon	0,94m ² /panel
2	Connect Adjustable wire hanger (Alt 1)	3/panel
3	Connect Covering cup (Alt 1, Optional)	3/panel
4	Connect Adjustable wire Kit (Alt 1, Optional)	3/panel
5	Connect Absorber anchor (Alt 1)	3/panel
Δ Min. overall depth of system: 140 mm		-
To install Connect Absorber Anchor, use Connect Absorber Anchor Bit.		-

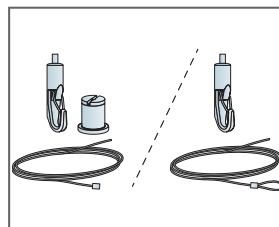

Two types of Adjustable wire solutions

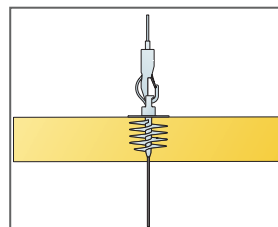

Panels can be suspended underneath each other

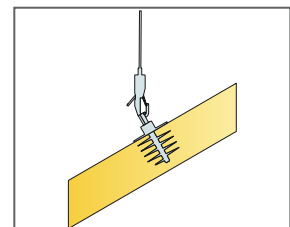

Panels can be installed in angles

Ecophon Solo™ Hexagon

Solo Hexagon is a free-hanging unit, offering high level design possibilities. Three different suspension systems offer opportunities to create several layers and angles. Suitable when the room volume should be maintained or when it's not possible to install a wall-to-wall ceiling.



SYSTEM RANGE



Size, mm	1040x1200
Special Fixing	•
Thickness	40
Inst. Diagr.	M426

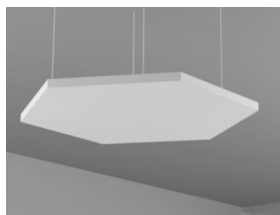

Suspension with Connect Adjustable wire hanger and Connect Absorber anchor

Acoustic



The values in the diagram refer to a single unit. If the units are arranged in a cluster with distances between units less than 0,5 meters, the Aeq per unit will be slightly reduced.

Sound Absorption:

Based on test results according to EN ISO 354.

A_{eq} Equivalent absorption area per unit (m² sabin)

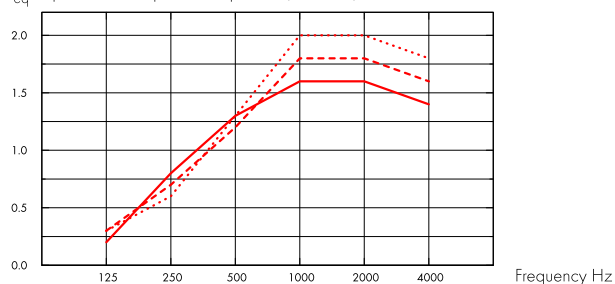

- Solo Hexagon 1040x1200, 200 mm o.d.s.
 - - - Solo Hexagon 1040x1200, 400 mm o.d.s.
 - ... Solo Hexagon 1040x1200, 1000 mm o.d.s.
- o.d.s = overall depth of system

THK mm	o.d.s. mm	A_{eq} Equivalent absorption area per unit (m ² sabin)					
		125 Hz	250 Hz	500 Hz	1000 Hz	2000 Hz	4000 Hz
40	200	0.2	0.8	1.3	1.6	1.6	1.4
40	400	0.3	0.7	1.2	1.8	1.8	1.6
40	1000	0.3	0.6	1.3	2.0	2.0	1.8

Indoor Air Quality



Certificate / Label

Eurofins Indoor Air Comfort®

IAC Gold

French VOC

A+



Cradle to Cradle Certified®



This product is Cradle to Cradle Certified® at Bronze level (version 4.0).



Material Health

This product has received a C2C Certified Material Health Certificate™ at the Silver level (standard version 4.0). The C2C Certified Material Health Certificate™ is a verification of the health and safety of a product's composition using the Material Health requirements of the Cradle-to-Cradle Certified Product Standard.



Carbon footprint

kg CO ₂ equiv/m ²		Life-cycle stages A1 to C4 from EPD, in conformity with ISO 14025 / EN 15804
Solo Freedom	8,41 (Solo Family EPD in conformity with ISO 14025 / EN 15804)	



Circularity

Minimum post-consumer recycled content	57%
Recyclability	Fully recyclable



Fire safety

Country	Fire standard	Class	The glass wool core of the tiles is tested and classified as non-combustible according to EN ISO 1182.
Europe	EN 13501-1	A2-s1,d0	



Humidity Resistance

Class C, relative humidity 95% and 30°C, according to EN 13964:2014



Visual appearance

White Frost, nearest NCS colour sample S 0500-N, 85% light reflectance. Gloss < 1.



Cleanability

Daily dusting and vacuum cleaning. Weekly wet wiping.



Accessibility

The tiles are demountable.



Installation

Installed according to installation diagrams, installation guides and drawing aid. For information regarding minimum overall depth of system see quantity specification.



System weight

kg/m ²		Weight information is indicative and subject to variation.
Solo Hexagon	4,7	



Mechanical properties

The tile can take both point loads and distributed loads. See Functional demands, Mechanical properties at www.ecophon.com.



CE

Ecophon ceiling systems are CE marked according to the European harmonized standard EN13964:2014. CE marked construction products are covered by a Declaration of Performance (DOP) which enables customers and users to easily compare performance of products available on the European market.

INSTALLATION DIAGRAM (M426) FOR ECOPHON SOLO HEXAGON

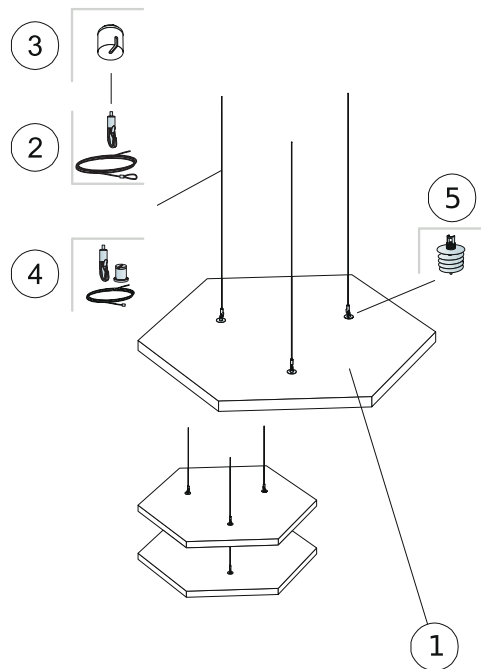

QUANTITY SPECIFICATION (EXCL. WASTAGE)

		Size, mm
		1040x1200
1	Solo Hexagon	0,94m ² /panel
2	Connect Adjustable wire hanger (Alt 1)	3/panel
3	Connect Covering cup (Alt 1, Optional)	3/panel
4	Connect Adjustable wire Kit (Alt 1, Optional)	3/panel
5	Connect Absorber anchor (Alt 1)	3/panel
Δ Min. overall depth of system: 140 mm		-
To install Connect Absorber Anchor, use Connect Absorber Anchor Bit.		-

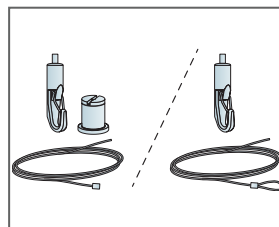
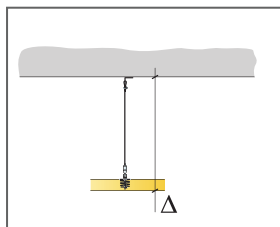

Two types of Adjustable wire solutions

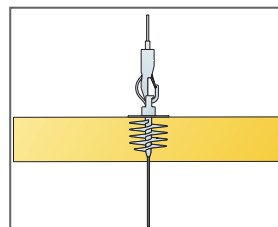

Panels can be suspended underneath each other

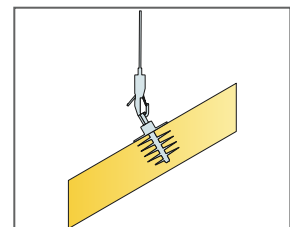

Panels can be installed in angles

Ecophon Solo™ Baffle

Solo Baffle is vertically installed unframed baffles. Solo Baffle can be used to form distinct lines and is available in different sizes and a wide range of colours. Baffles are used primarily when natural light is brought into the room via skylight.



Plantorics, Hoofddorp, Netherlands

SYSTEM RANGE

Size, mm	1200x200	1200x300	1200x600	1800x200	1800x300	1800x600
Special Fixing	•	•	•	•	•	•
Thickness	40	40	40	40	40	40
Inst. Diag.	M414, M491, M563, M580	M414, M491, M563, M580	M414, M491, M563, M580	M414, M491, M563, M580	M414, M491, M563, M580	M414, M491, M563, M580

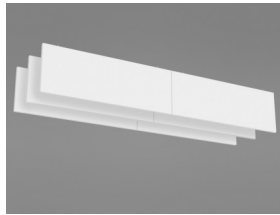

Solo Baffle



Solo Baffle/Anchor



Solo Baffle/Anchor installation

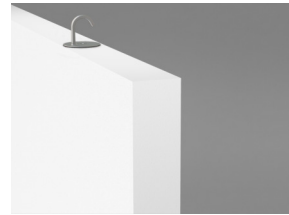

Solo Baffle/Hook

Acoustic



Sound Absorption:

Test results according to EN ISO 354:2003 NOTE: Results shown are not comparable with results according to older versions of this standard due to discrepancies in test method. Classification according to EN ISO 11654, and the single value ratings for Noise Reduction Coefficient, NRC and Sound Absorption Average, SAA according to ASTM C 423.

α_p , Practical sound absorption coefficient

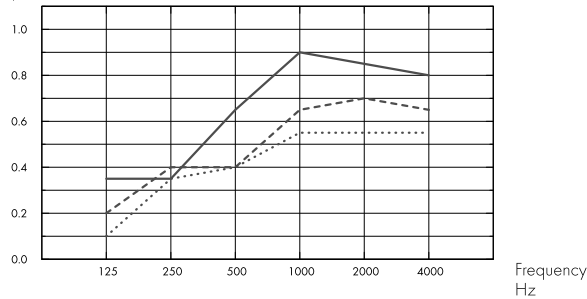

.... Solo Baffle 1200/1800x200, spacing 600mm, direct mounting

--- Solo Baffle 1200/1800x300, spacing 600mm, direct mounting

- Solo Baffle 1200/1800x600, spacing 600mm, direct mounting

o.d.s = overall depth of system

A_{eq} , Equivalent absorption area per unit (m² sabin)

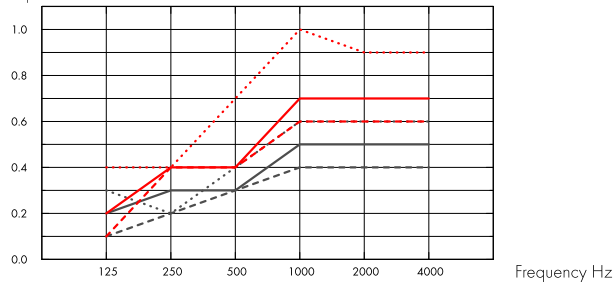

--- Solo Baffle 1200x200

- Solo Baffle 1200x300

.... Solo Baffle 1200x600

--- Solo Baffle 1800x200

- Solo Baffle 1800x300

.... Solo Baffle 1800x600

o.d.s = overall depth of system

	THK mm	o.d.s. mm	α_p , Practical sound absorption coefficient						α_w
			125 Hz	250 Hz	500 Hz	1000 Hz	2000 Hz	4000 Hz	
c600	40	200	0.10	0.35	0.40	0.55	0.55	0.55	0.50
c600	40	300	0.20	0.40	0.40	0.65	0.70	0.65	0.50
c600	40	600	0.35	0.35	0.65	0.90	0.85	0.80	0.65

	THK mm	o.d.s. mm	A_{eq} , Equivalent absorption area per unit (m ² sabin)					
			125 Hz	250 Hz	500 Hz	1000 Hz	2000 Hz	4000 Hz
1200x200 c600	40	200	0.1	0.2	0.3	0.4	0.4	0.4
1200x300 c600	40	300	0.2	0.3	0.3	0.5	0.5	0.5
1200x600 c600	40	600	0.3	0.2	0.4	0.6	0.6	0.6
1800x200 c600	40	200	0.1	0.4	0.4	0.6	0.6	0.6
1800x300 c600	40	300	0.2	0.4	0.4	0.7	0.7	0.7
1800x600 c600	40	600	0.4	0.4	0.7	1.0	0.9	0.9

	THK mm	o.d.s. mm	NRC	SAA
c200	40	200	0.65	0.65
c400	40	200	0.50	0.51
c600	40	200	0.45	0.43
c800	40	200	0.40	0.37
c200	40	300	0.70	0.71
c400	40	300	0.60	0.61
c600	40	300	0.55	0.53
c800	40	300	0.45	0.46
c200	40	600	0.80	0.82
c400	40	600	0.75	0.74
c600	40	600	0.70	0.67
c800	40	600	0.60	0.60



Indoor Air Quality

Certificate / Label	
Eurofins Indoor Air Comfort®	IAC Gold
French VOC	A+



Cradle to Cradle Certified®



This product is Cradle to Cradle Certified® at Bronze level (version 4.0).



Material Health

This product has received a C2C Certified Material Health Certificate™ at the Silver level (standard version 4.0). The C2C Certified Material Health Certificate™ is a verification of the health and safety of a product's composition using the Material Health requirements of the Cradle-to-Cradle Certified Product Standard.



Carbon footprint

	kg CO ₂ equiv/m ²	Life-cycle stages A1 to C4 from EPD, in conformity with ISO 14025 / EN 15804
Solo Baffle	10,11	



Circularity

Minimum post-consumer recycled content	57%
Recyclability	Fully recyclable



Fire safety

Country	Fire standard	Class
Europe	EN 13501-1	A2-s1,d0

The glass wool core of the tiles is tested and classified as non-combustible according to EN ISO 1182.



Humidity Resistance

Class C, relative humidity 95% and 30°C, according to EN 13964:2014



Visual appearance

White Frost, nearest NCS colour sample S 0500-N, 85% light reflectance. Gloss < 1.



Cleanability

Daily dusting and vacuum cleaning. Weekly wet wiping.



Accessibility

The tiles are demountable.



Installation

Installed according to installation diagrams, installation guides and drawing aid. For information regarding minimum overall depth of system see quantity specification.



System weight

	kg/m ²	Weight information is indicative and subject to variation.
Solo Baffle	4,6	



Mechanical properties

Additional live load has to be fixed to the soffit.



CE

Ecophon ceiling systems are CE marked according to the European harmonized standard EN13964:2014. CE marked construction products are covered by a Declaration of Performance (DOP) which enables customers and users to easily compare performance of products available on the European market.

INSTALLATION DIAGRAM (M414) FOR ECOPHON SOLO BAFFLE/ANCHOR

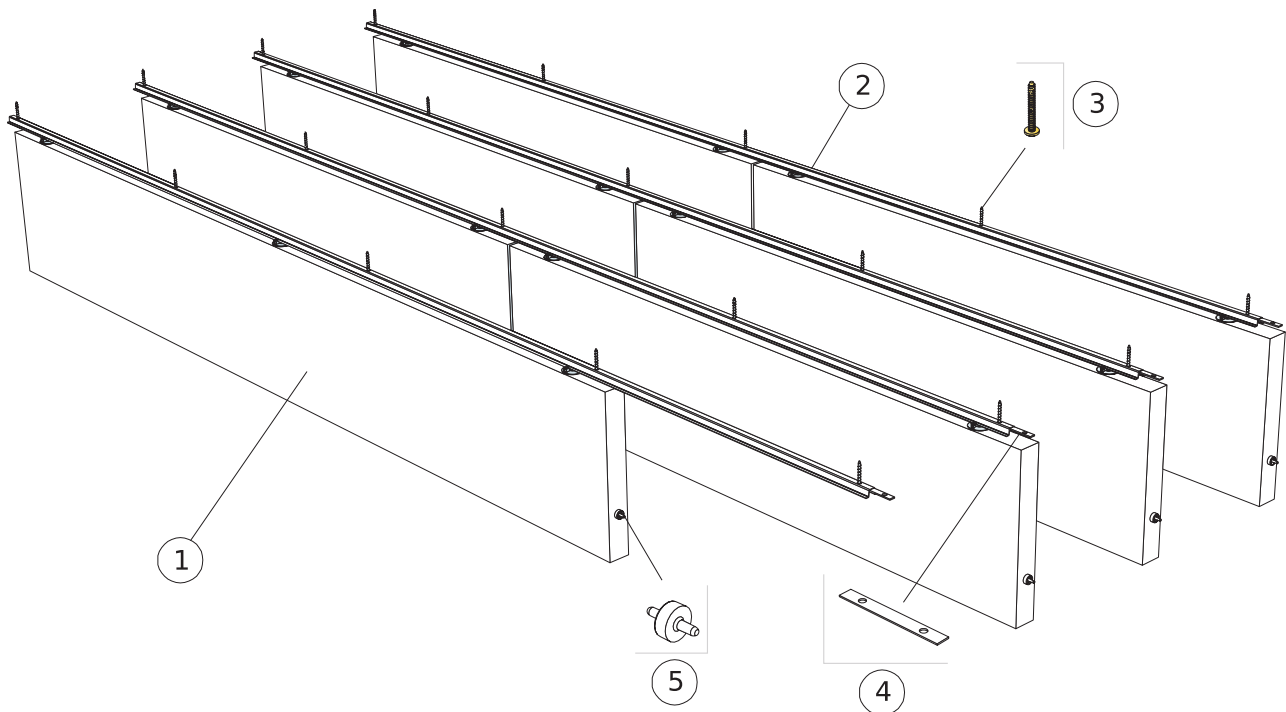

QUANTITY SPECIFICATION (EXCL. WASTAGE)

	Size, mm					
	1200x200	1200x300	1200x600	1800x200	1800x300	1800x600
1 Solo Baffle/Anchor	2,8/m ²	2,8/m ²	2,8/m ²	1,9/m ²	1,9/m ²	1,9/m ²
2 Connect Baffle Profile, installed at 300 mm centres	3,3m/m ²	3,3m/m ²	3,3m/m ²	3,3m/m ²	3,3m/m ²	3,3m/m ²
3 Connect Anchor Screw, fixed at 1200 mm centres	2,8/m ²	2,8/m ²	2,8/m ²	2,8/m ²	2,8/m ²	2,8/m ²
4 Connect Profile connector, installed at 2400 mm centres	1,4/m ²	1,4/m ²	1,4/m ²	1,4/m ²	1,4/m ²	1,4/m ²
5 Connect Guiding pin, installed at 1200 mm centres	2,8/m ²	2,8/m ²	2,8/m ²	1,9/m ²	1,9/m ²	1,9/m ²

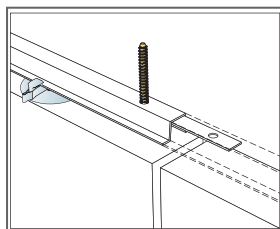

Fixing of Connect Profile connector

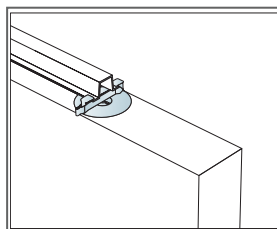

The baffles are secured with clips

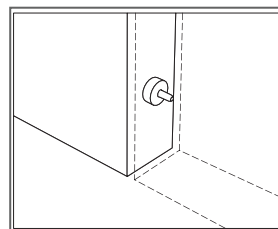

Connect Guiding pin, used to fix distance and level between panels

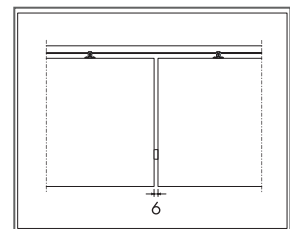

Distinct gap of 6 mm between baffles with Connect Guiding pin

INSTALLATION DIAGRAM (M491) FOR ECOPHON SOLO BAFFLE/HOOK

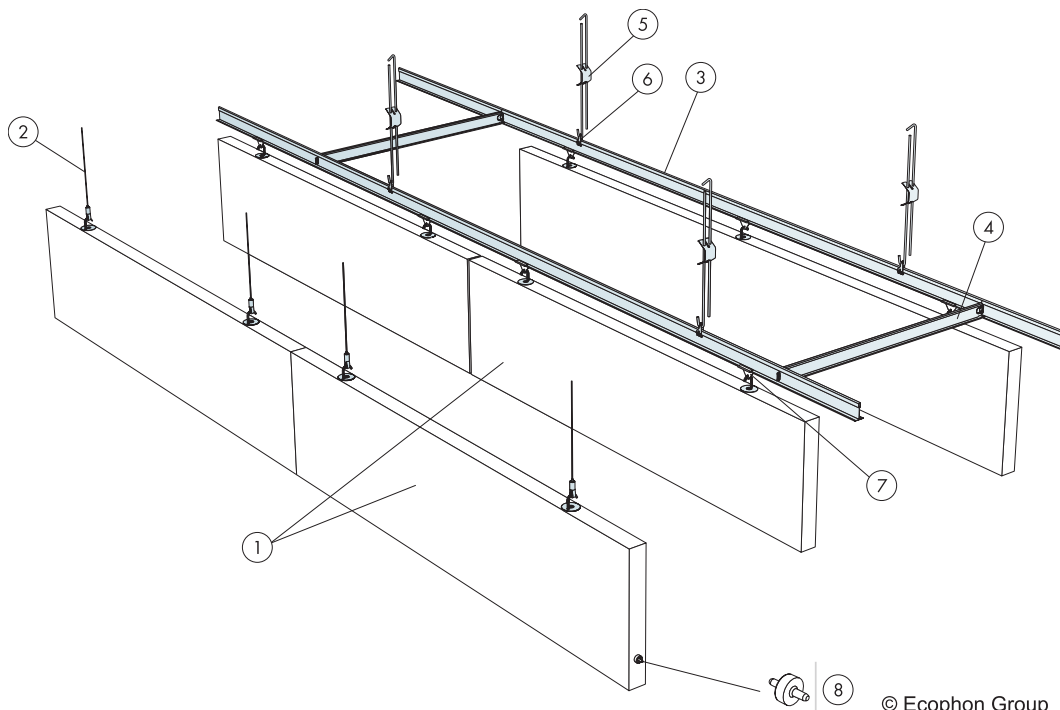

QUANTITY SPECIFICATION (EXCL. WASTAGE)

	Size, mm					
	1200x200	1200x300	1200x600	1800x200	1800x300	1800x600
1 Solo Baffle/Hook	1,4/m ²	1,4/m ²	1,4/m ²	0,9/m ²	0,9/m ²	0,9/m ²
2 Connect Adjustable wire hanger (Alt 1)	2/panel	2/panel	2/panel	3/panel	3/panel	3/panel
3 Connect T24 Main runner, installed at 600 mm centres	1,7m/m ²	1,7m/m ²	1,7m/m ²	1,7m/m ²	1,7m/m ²	1,7m/m ²
4 Connect T24 Cross tee, L=600 mm, installed at 1800 mm centres	0,6m/m ²	0,6m/m ²	0,6m/m ²	0,6m/m ²	0,6m/m ²	0,6m/m ²
5 Connect Adjustable hanger (Alt 2)	1,4/m ²	1,4/m ²	1,4/m ²	1,4/m ²	1,4/m ²	1,4/m ²
6 Connect Hanger clip (Alt 2)	1,4/m ²	1,4/m ²	1,4/m ²	1,4/m ²	1,4/m ²	1,4/m ²
7 Connect Baffle clip C3 (Alt 2)	2,8/m ²	2,8/m ²	2,8/m ²	2,8/m ²	2,8/m ²	2,8/m ²
8 Connect Guiding pin, installed at 1200 mm centres	2,8/m ²	2,8/m ²	2,8/m ²	0,9/m ²	0,9/m ²	0,9/m ²

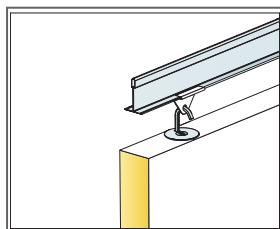

Detail of suspension

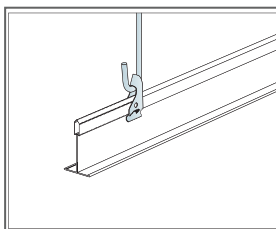

Suspension with adjustable hanger and clip

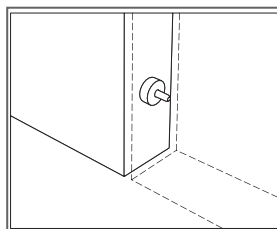

Connect Guiding pin, used to fix distance and level between panels

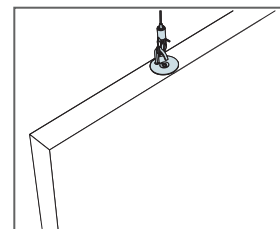

Suspension with Connect Adjustable wire hanger

INSTALLATION DIAGRAM (M563) FOR ECOPHON SOLO BAFFLE/ANCHOR

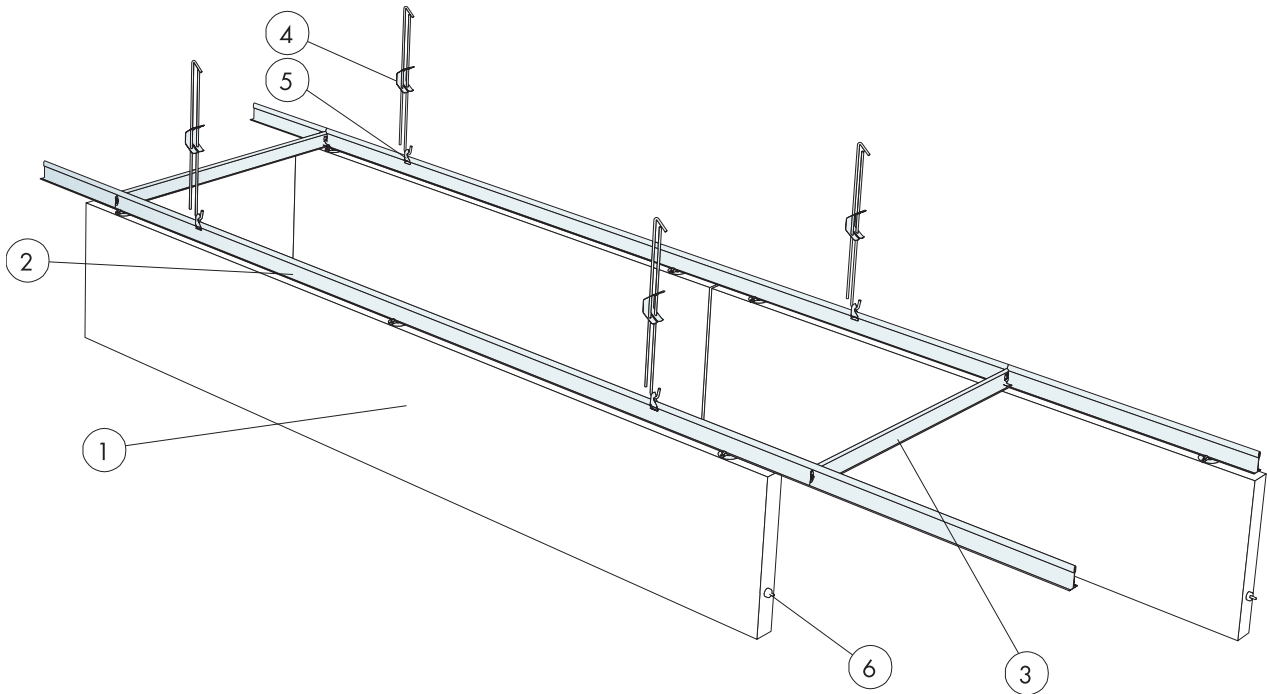

© Ecophon Group

QUANTITY SPECIFICATION (EXCL. WASTAGE)

	Size, mm					
	1200x200	1200x300	1200x600	1800x200	1800x300	1800x600
1 Solo Baffle/Anchor	1,4/m ²	1,4/m ²	1,4/m ²	0,9/m ²	0,9/m ²	0,9/m ²
2 Connect T24 Main runner, installed at 600 mm centres	1,7m/m ²	1,7m/m ²	1,7m/m ²	1,7m/m ²	1,7m/m ²	1,7m/m ²
3 Connect T24 Cross tee, L=600 mm, installed at 1800 mm centres	0,6m/m ²	0,6m/m ²	0,6m/m ²	0,6m/m ²	0,6m/m ²	0,6m/m ²
4 Connect Adjustable hanger (Alt 2)	1,4/m ²	1,4/m ²	1,4/m ²	1,4/m ²	1,4/m ²	1,4/m ²
5	-	-	0,7/m ²	-	-	-
6 Connect Guiding pin, installed at 1200 mm centres	2,8/m ²	2,8/m ²	2,8/m ²	0,9/m ²	0,9/m ²	0,9/m ²

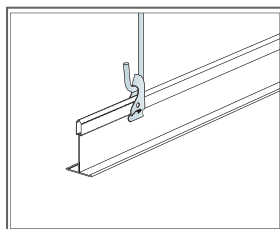

Suspension with adjustable hanger and clip

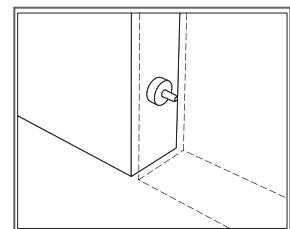

Connect Guiding pin, used to fix distance and level between panels

INSTALLATION DIAGRAM (M563) FOR ECOPHON SOLO BAFFLE/HOOK

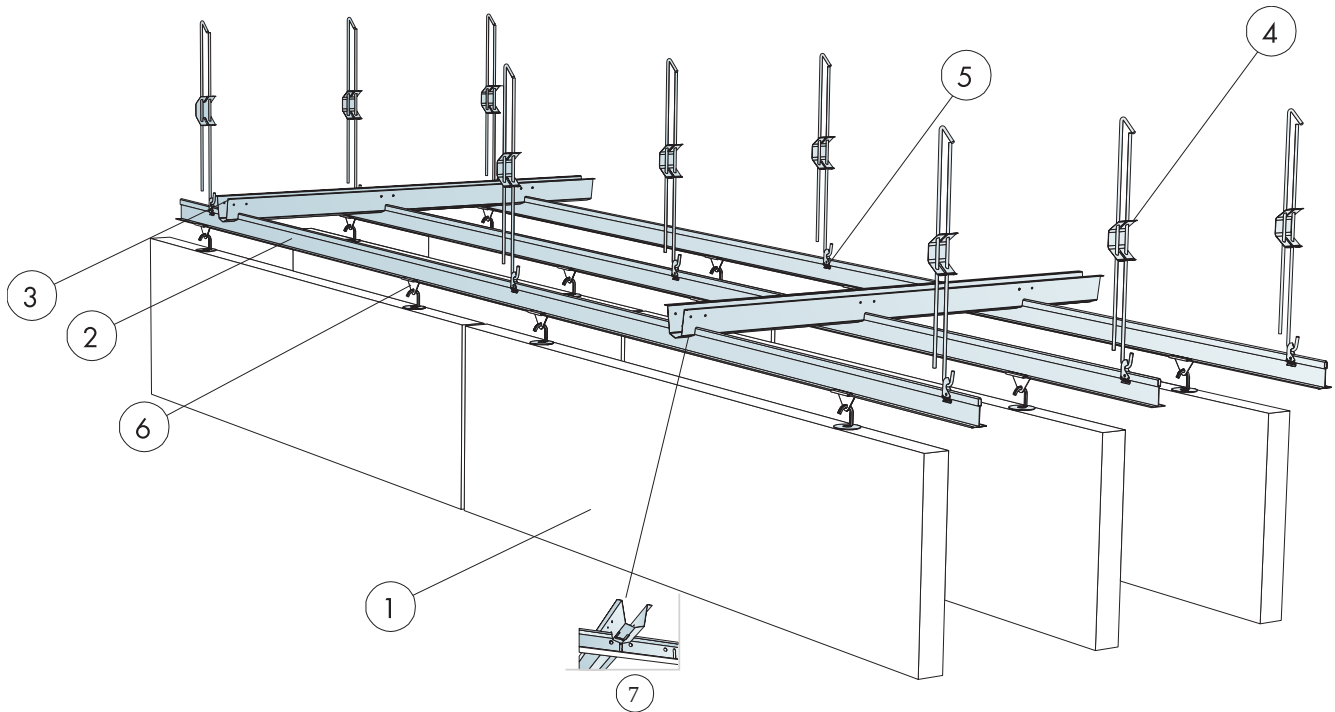

QUANTITY SPECIFICATION (EXCL. WASTAGE)

	Size, mm					
	1200x200	1200x300	1200x600	1800x200	1800x300	1800x600
1 Solo Baffle/Hook	1,4/m ²	1,4/m ²	1,4/m ²	1,9/m ²	1,9/m ²	1,9/m ²
2 Connect T24 Main runner HD (Black, Grey) / PL(White Only), installed at 600 mm centres	-	-	-	-	-	1,7m/m ²
3 Connect Space bar	-	-	as required	-	-	as required
4 Connect Adjustable hanger (Alt 2)	1,4/m ²	1,4/m ²	1,4/m ²	1,4/m ²	1,4/m ²	1,4/m ²
5	-	-	0,7/m ²	-	-	-
6 Connect Baffle clip C3 (Alt 2)	2,8/m ²	2,8/m ²	2,8/m ²	2,8/m ²	2,8/m ²	2,8/m ²
7 Connect Space bar winch, installed one per joint Main runner/Space bar	-	-	1,1/m ²	-	-	1,1/m ²
	-	-	-	-	-	-

Ecophon Solo™ Baffle Wave

Solo Baffle Wave is vertically installed unframed baffles. The wave-shaped baffle gives the room a special design and possibility to express design in shape and colour. Baffles are used primarily when natural light is brought into the room via skylight.



Kurikka Campus, Kurikka, Finland

SYSTEM RANGE



Size, mm	1800x300	1800x600
Special Fixing	•	•
Thickness	40	40
Inst. Diagr.	M495, M419	M495, M419

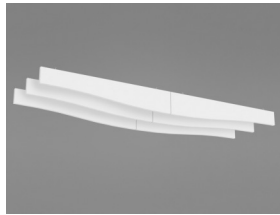

Solo Baffle Wave



Solo Baffle/Anchor



Solo Baffle/Anchor installation

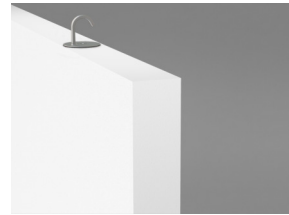

Solo Baffle/Hook

Acoustic



Sound Absorption:

Test results according to EN ISO 354:2003 NOTE: Results shown are not comparable with results according to older versions of this standard due to discrepancies in test method. Classification according to EN ISO 11654, and the single value ratings for Noise Reduction Coefficient, NRC and Sound Absorption Average, SAA according to ASTM C 423.

α_p , Practical sound absorption coefficient

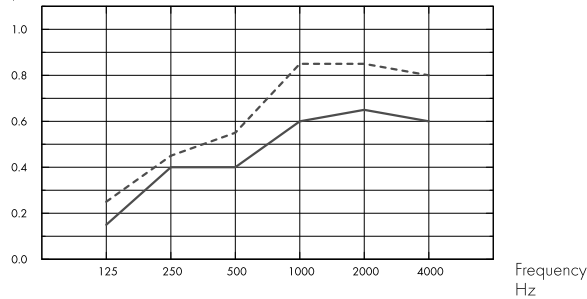

- Solo Baffle Wave 1800x300/200, spacing 600, direct mounting
 - Solo Baffle Wave 1800x600/300, spacing 600, direct mounting
- o.d.s = overall depth of system

A_{eq} , Equivalent absorption area per unit (m² sabin)

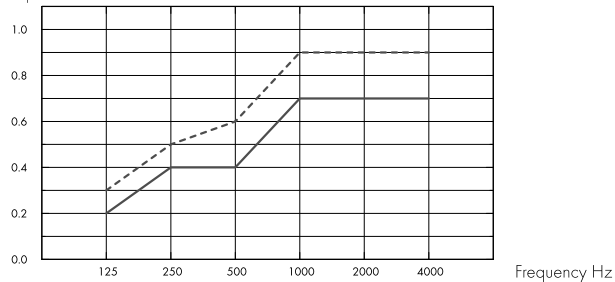

- Solo Baffle Wave 1800x300/200
 - Solo Baffle Wave 1800x600/300
- o.d.s = overall depth of system

	THK mm	o.d.s. mm	α_p , Practical sound absorption coefficient						α_w
			125 Hz	250 Hz	500 Hz	1000 Hz	2000 Hz	4000 Hz	
c600	40	300	0.15	0.40	0.40	0.60	0.65	0.60	0.50
c600	40	600	0.25	0.45	0.55	0.85	0.85	0.80	0.65

	THK mm	o.d.s. mm	A_{eq} , Equivalent absorption area per unit (m ² sabin)					
			125 Hz	250 Hz	500 Hz	1000 Hz	2000 Hz	4000 Hz
c600	40	300	0.2	0.4	0.4	0.7	0.7	0.7
c600	40	600	0.3	0.5	0.6	0.9	0.9	0.9

	THK mm	o.d.s. mm	NRC	SAA
c600	40	300	0.50	0.52
c600	40	600	0.70	0.68



Indoor Air Quality

Certificate / Label	
Eurofins Indoor Air Comfort®	IAC Gold
French VOC	A+



Cradle to Cradle Certified®



This product is Cradle to Cradle Certified® at Bronze level (version 4.0).



Material Health

This product has received a C2C Certified Material Health Certificate™ at the Silver level (standard version 4.0). The C2C Certified Material Health Certificate™ is a verification of the health and safety of a product's composition using the Material Health requirements of the Cradle-to-Cradle Certified Product Standard.



Carbon footprint

	kg CO ₂ equiv/m ²	Life-cycle stages A1 to C4 from EPD, in conformity with ISO 14025 / EN 15804
Solo Baffle Wave	11,07	



Circularity

Minimum post-consumer recycled content	57%
Recyclability	Fully recyclable



Fire safety

Country	Fire standard	Class
Europe	EN 13501-1	A2-s1,d0

The glass wool core of the tiles is tested and classified as non-combustible according to EN ISO 1182.



Humidity Resistance

Class C, relative humidity 95% and 30°C, according to EN 13964:2014



Visual appearance

White Frost, nearest NCS colour sample S 0500-N, 85% light reflectance. Gloss < 1.



Cleanability

Daily dusting and vacuum cleaning. Weekly wet wiping.



Accessibility

The tiles are demountable.



Installation

Installed according to installation diagrams, installation guides and drawing aid. For information regarding minimum overall depth of system see quantity specification.



System weight

	kg/m ²	Weight information is indicative and subject to variation.
Solo Baffle	4,6	



Mechanical properties

Additional live load has to be fixed to the soffit.



CE

Ecophon ceiling systems are CE marked according to the European harmonized standard EN 13964:2014. CE marked construction products are covered by a Declaration of Performance (DOP) which enables customers and users to easily compare performance of products available on the European market.

INSTALLATION DIAGRAM (M495) FOR ECOPHON SOLO BAFFLE WAVE/HOOK

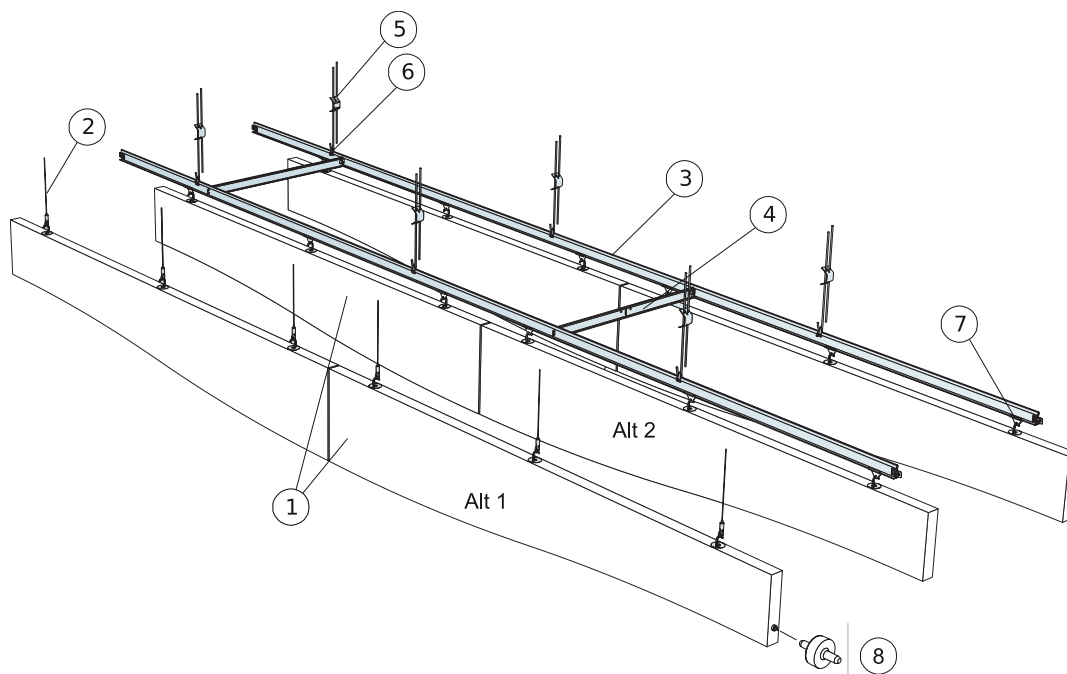

© Ecophon Group

QUANTITY SPECIFICATION (EXCL. WASTAGE)

	Size, mm	
	1800x300	1800x600
1 Solo Baffle/Hook	0,9/m ²	0,9/m ²
2 Connect Adjustable wire hanger (Alt 1)	3/panel	3/panel
3 Connect T24 Main runner, installed at 600 mm centres	1,7m/m ²	1,7m/m ²
4 Connect T24 Cross tee, L=600 mm, installed at 1800 mm centres	0,6m/m ²	0,6m/m ²
5 Connect Adjustable hanger (Alt 2)	1,4/m ²	1,4/m ²
6 Connect Hanger clip (Alt 2)	1,4/m ²	1,4/m ²
7 Connect Baffle clip C3 (Alt 2)	2,8/m ²	2,8/m ²
8 Connect Guiding pin, installed at 1200 mm centres	0,9/m ²	0,9/m ²

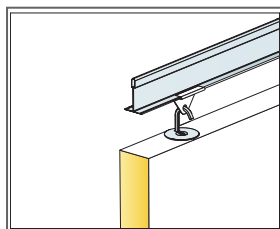

Detail of suspension

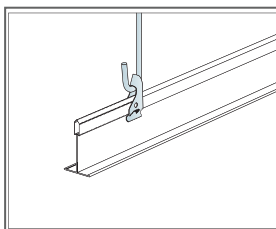

Suspension with adjustable hanger and clip

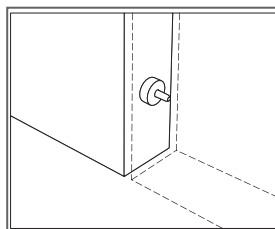

Connect Guiding pin, used to fix distance and level between panels

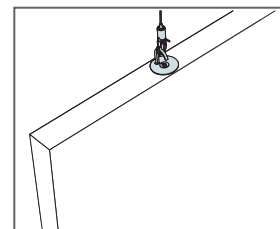

Suspension with Connect Adjustable wire hanger

INSTALLATION DIAGRAM (M419) FOR ECOPHON SOLO BAFFLE WAVE/ANCHOR

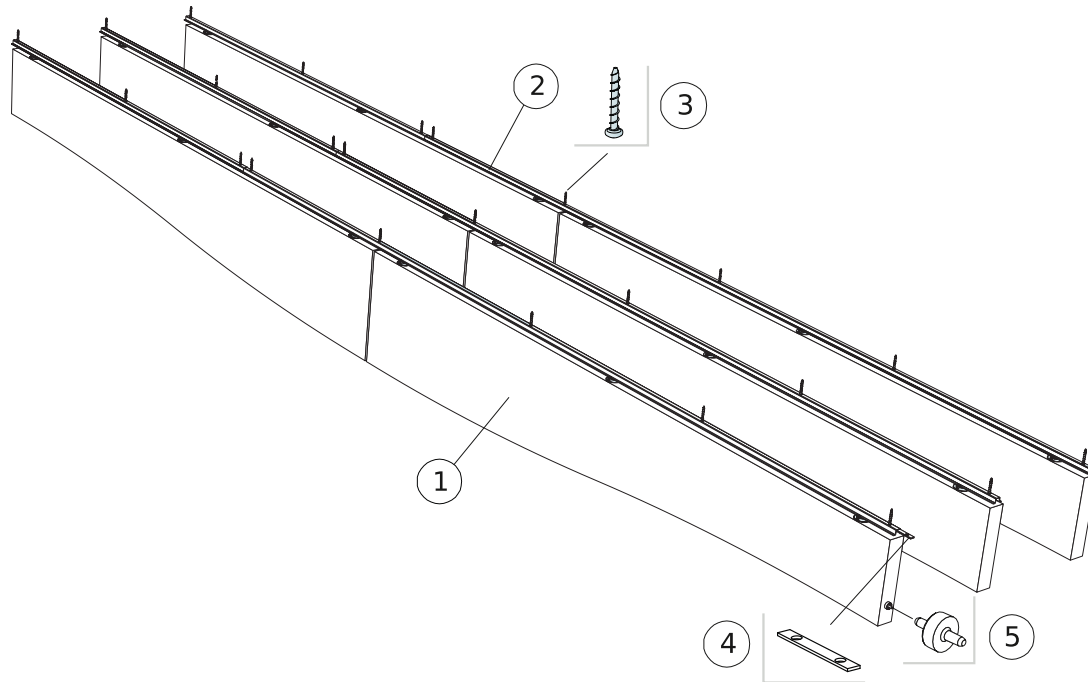

© Ecophon Group

QUANTITY SPECIFICATION (EXCL. WASTAGE)

	Size, mm	
	1800x300	1800x600
1 Solo Baffle/Anchor	1,9/m ²	1,9/m ²
2 Connect Baffle Profile, installed at 300 mm centres	3,3m/m ²	3,3m/m ²
3 Connect Anchor Screw, fixed at 1200 mm centres	2,8/m ²	2,8/m ²
4 Connect Profile connector, installed at 2400 mm centres	1,4/m ²	1,4/m ²
5 Connect Guiding pin, installed at 1800 mm centres	1,9/m ²	1,9/m ²

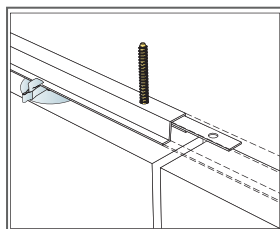

Fixing of Connect Profile connector

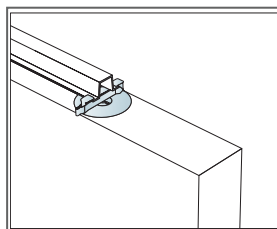

The baffles are secured with clips

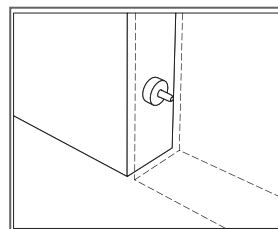

Connect Guiding pin, used to fix distance and level between panels

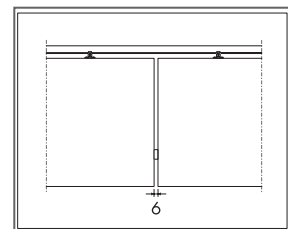

Distinct gap of 6 mm between baffles with Connect Guiding pin

Ecophon Solo™ Baffle ZigZag

Solo Baffle ZigZag is vertically installed unframed baffles. The zigzag-shaped baffle gives the room a special design and possibility to express design in shape and colour. Baffles are used primarily when natural light is brought into the room via skylight.



SYSTEM RANGE



Size, mm	1800x300	1800x600
Special Fixing	•	•
Thickness	40	40
Inst. Diag.	M496, M417	M496, M417

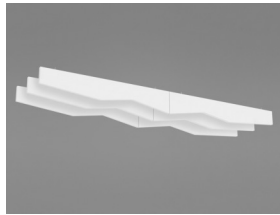

Solo Baffle ZigZag

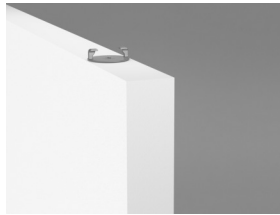

Solo Baffle/Anchor



Solo Baffle/Anchor installation

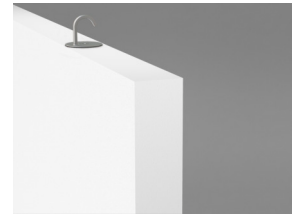

Solo Baffle ZigZag/hook

Acoustic



Sound Absorption:

Test results according to EN ISO 354:2003 NOTE: Results shown are not comparable with results according to older versions of this standard due to discrepancies in test method. Classification according to EN ISO 11654, and the single value ratings for Noise Reduction Coefficient, NRC and Sound Absorption Average, SAA according to ASTM C 423.

α_p , Practical sound absorption coefficient

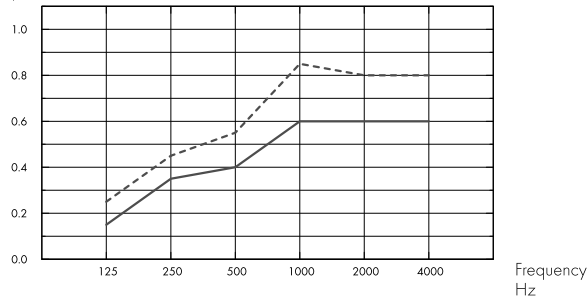

- Solo Baffle ZigZag 1800x300/200, spacing 600, direct mounting
 - Solo Baffle ZigZag 1800x600/300, spacing 600, direct mounting
- o.d.s = overall depth of system

A_{eq} , Equivalent absorption area per unit (m² sabin)

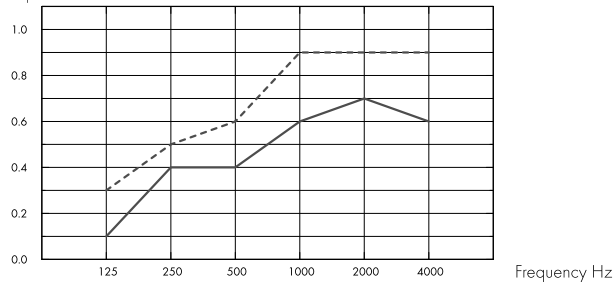

- Solo Baffle ZigZag 1800x300/200
 - Solo Baffle ZigZag 1800x600/300
- o.d.s = overall depth of system

	THK mm	o.d.s. mm	α_p , Practical sound absorption coefficient						α_w
			125 Hz	250 Hz	500 Hz	1000 Hz	2000 Hz	4000 Hz	
c600	40	300	0.15	0.35	0.40	0.60	0.60	0.60	0.50
c600	40	600	0.25	0.45	0.55	0.85	0.80	0.80	0.65

	THK mm	o.d.s. mm	A_{eq} , Equivalent absorption area per unit (m ² sabin)					
			125 Hz	250 Hz	500 Hz	1000 Hz	2000 Hz	4000 Hz
c600	40	300	0.1	0.4	0.4	0.6	0.7	0.6
c600	40	600	0.3	0.5	0.6	0.9	0.9	0.9

	THK mm	o.d.s. mm	NRC	SAA
c600	40	300	0.50	0.49
c600	40	600	0.65	0.65



Indoor Air Quality

Certificate / Label	
Eurofins Indoor Air Comfort®	IAC Gold
French VOC	A+



Cradle to Cradle Certified®



This product is Cradle to Cradle Certified® at Bronze level (version 4.0).



Material Health

This product has received a C2C Certified Material Health Certificate™ at the Silver level (standard version 4.0). The C2C Certified Material Health Certificate™ is a verification of the health and safety of a product's composition using the Material Health requirements of the Cradle-to-Cradle Certified Product Standard.



Carbon footprint

	kg CO ₂ equiv/m ²	Life-cycle stages A1 to C4 from EPD, in conformity with ISO 14025 / EN 15804
Solo Baffle ZigZag	11,13	



Circularity

Minimum post-consumer recycled content	57%
Recyclability	Fully recyclable



Fire safety

Country	Fire standard	Class
Europe	EN 13501-1	A2-s1,d0

The glass wool core of the tiles is tested and classified as non-combustible according to EN ISO 1182.



Humidity Resistance

Class C, relative humidity 95% and 30°C, according to EN 13964:2014



Visual appearance

White Frost, nearest NCS colour sample S 0500-N, 85% light reflectance. Gloss < 1.



Cleanability

Daily dusting and vacuum cleaning. Weekly wet wiping.



Accessibility

The tiles are demountable.



Installation

Installed according to installation diagrams, installation guides and drawing aid. For information regarding minimum overall depth of system see quantity specification.



System weight

	kg/m ²	Weight information is indicative and subject to variation.
Solo Baffle	4,6	



Mechanical properties

Additional live load has to be fixed to the soffit.



CE

Ecophon ceiling systems are CE marked according to the European harmonized standard EN 13964:2014. CE marked construction products are covered by a Declaration of Performance (DOP) which enables customers and users to easily compare performance of products available on the European market.

INSTALLATION DIAGRAM (M496) FOR ECOPHON SOLO BAFFLE ZIGZAG/HOOK

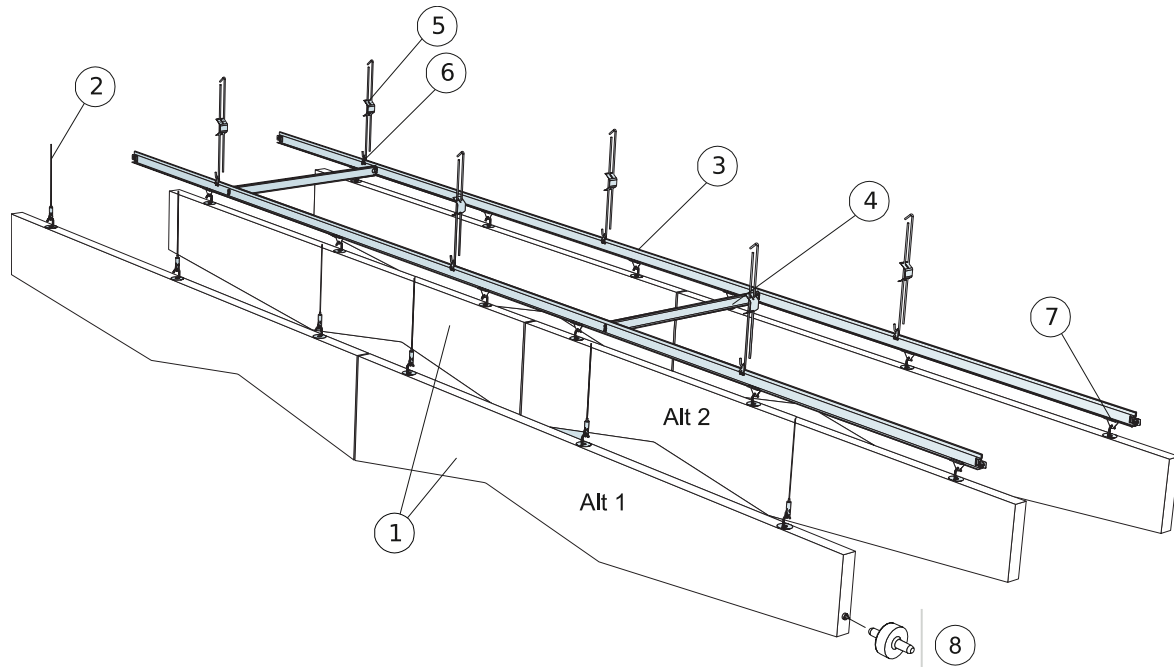

© Ecophon Group

QUANTITY SPECIFICATION (EXCL. WASTAGE)

	Size, mm	
	1800x300	1800x600
1 Solo Baffle/Hook	0,9/m ²	0,9/m ²
2 Connect Adjustable wire hanger (Alt 1)	3/panel	3/panel
3 Connect T24 Main runner, installed at 600 mm centres	1,7m/m ²	1,7m/m ²
4 Connect T24 Cross tee, L=600 mm, installed at 1800 mm centres	0,6m/m ²	0,6m/m ²
5 Connect Adjustable hanger (Alt 2)	1,4/m ²	1,4/m ²
6 Connect Hanger clip (Alt 2)	1,4/m ²	1,4/m ²
7 Connect Baffle clip C3 (Alt 2)	2,8/m ²	2,8/m ²
8 Connect Guiding pin, installed at 1200 mm centres	0,9/m ²	0,9/m ²

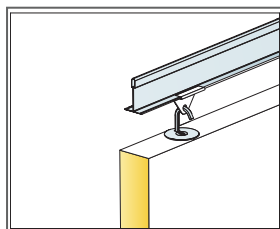

Detail of suspension

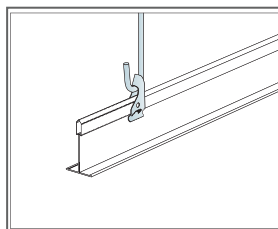

Suspension with adjustable hanger and clip

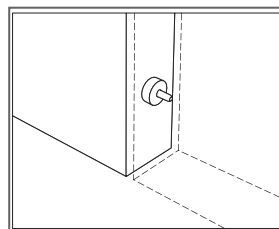

Connect Guiding pin, used to fix distance and level between panels

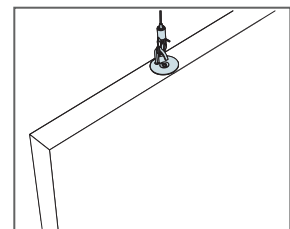

Suspension with Connect Adjustable wire hanger

INSTALLATION DIAGRAM (M417) FOR ECOPHON SOLO BAFFLE ZIG ZAG

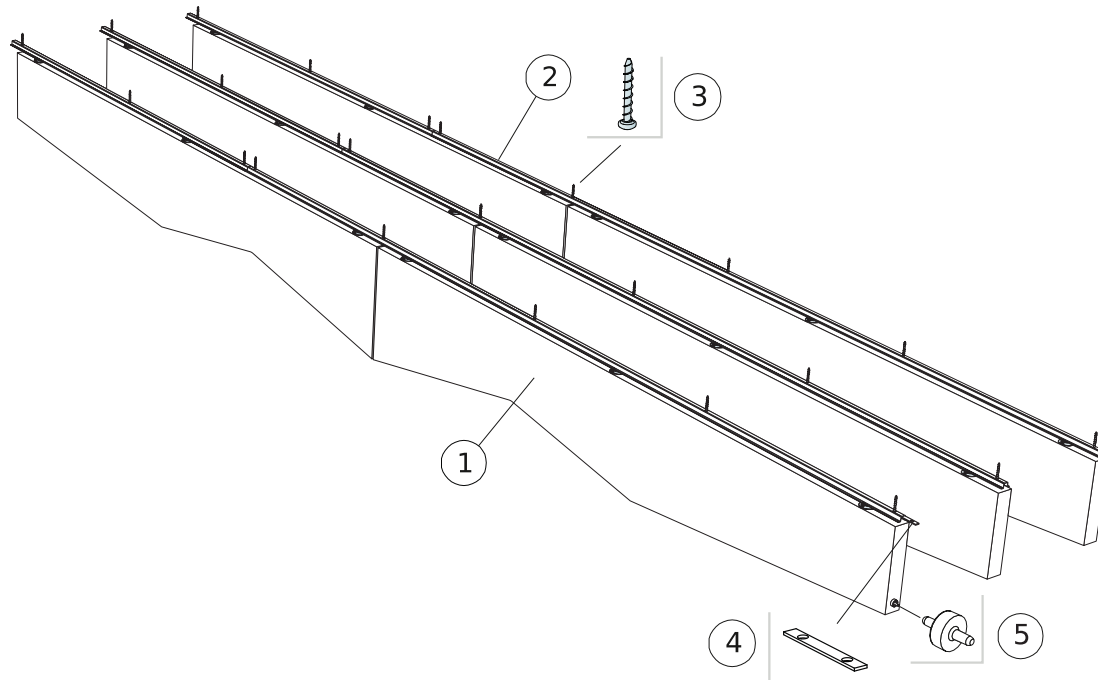

© Ecophon Group

QUANTITY SPECIFICATION (EXCL. WASTAGE)

	Size, mm	
	1800x300	1800x600
1 Solo Baffle/Anchor	1,9/m ²	1,9/m ²
2 Connect Baffle Profile, installed at 300 mm centres	3,3m/m ²	3,3m/m ²
3 Connect Anchor Screw, fixed at 1200 mm centres	2,8/m ²	2,8/m ²
4 Connect Profile connector, installed at 2400 mm centres	1,4/m ²	1,4/m ²
5 Connect Guiding pin, installed at 1800 mm centres	1,9/m ²	1,9/m ²

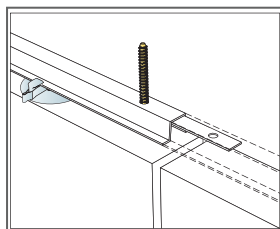

Fixing of Connect Profile connector

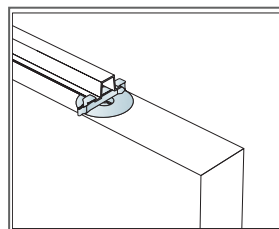

The baffles are secured with clips

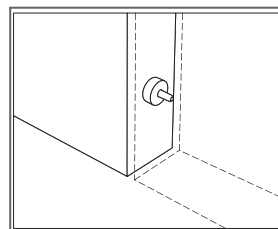

Connect Guiding pin, used to fix distance and level between panels

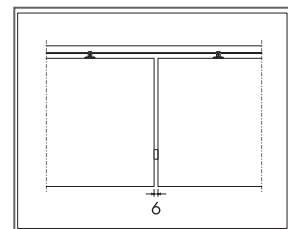

Distinct gap of 6 mm between baffles with Connect Guiding pin

Ecophon Solo™ Baffle Wall

Ecophon Solo™ Baffle Wall are acoustic solutions for walls. Solo Baffle Wall are suitable in buildings where you want to express design and have freedom to create patterns with different sizes and colours.

With Connect™ Baffle wall fixing you will easily attach the baffle to the wall.



Clientèle, Johannesburg, South Africa

SYSTEM RANGE



Size, mm	1200x200	1200x300
Special Fixing	•	•
Thickness	40	40
Inst. Diagr.	M420	M420

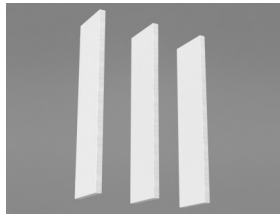

Solo Baffle Wall

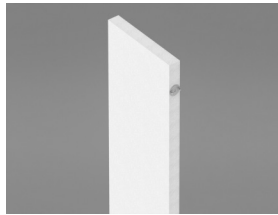

Solo Baffle/Anchor



Solo Baffle/Anchor

Acoustic



For acoustic data on the panel - please see Solo Baffle.

Indoor Air Quality



Certificate / Label	
Eurofins Indoor Air Comfort®	IAC Gold
French VOC	A+



Cradle to Cradle Certified®



This product is Cradle to Cradle Certified® at Bronze level (version 4.0).



Material Health

This product has received a C2C Certified Material Health Certificate™ at the Silver level (standard version 4.0). The C2C Certified Material Health Certificate™ is a verification of the health and safety of a product's composition using the Material Health requirements of the Cradle-to-Cradle Certified Product Standard.



Carbon footprint

	kg CO ₂ equiv/m ²
Solo Baffle Wall	10,11

Life-cycle stages A1 to C4 from EPD, in conformity with ISO 14025 / EN 15804



Circularity

Minimum post-consumer recycled content	57%
Recyclability	Fully recyclable



Fire safety

Country	Fire standard	Class
Europe	EN 13501-1	A2-s1,d0

The glass wool core of the tiles is tested and classified as non-combustible according to EN ISO 1182.



Humidity Resistance

Class C, relative humidity 95% and 30°C, according to EN 13964:2014



Visual appearance

White Frost, nearest NCS colour sample S 0500-N, 85% light reflectance. Gloss < 1.



Cleanability

Daily dusting and vacuum cleaning. Weekly wet wiping.



Accessibility

The tiles are demountable.



System weight

	kg/m ²	Weight information is indicative and subject to variation.
Solo Baffle	4,6	



Installation

Installed according to installation diagrams, installation guides and drawing aid. For information regarding minimum overall depth of system see quantity specification.



Mechanical properties

Additional live load has to be fixed to the soffit.



CE

Ecophon ceiling systems are CE marked according to the European harmonized standard EN13964:2014. CE marked construction products are covered by a Declaration of Performance (DOP) which enables customers and users to easily compare performance of products available on the European market.

INSTALLATION DIAGRAM (M420) FOR ECOPHON SOLO BAFFLE WALL

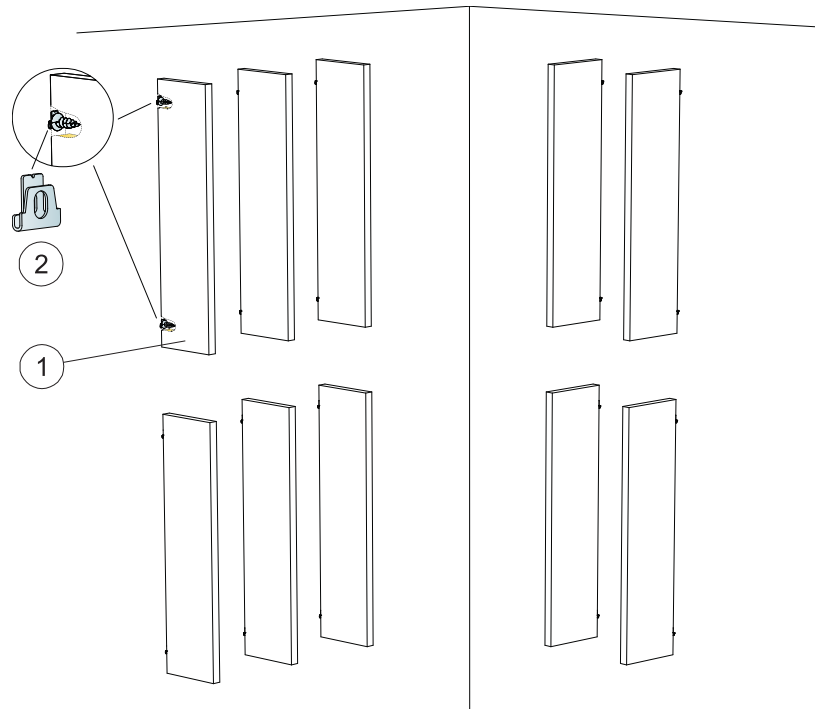

QUANTITY SPECIFICATION (EXCL. WASTAGE)

		Size, mm	
		1200x200	1200x300
1	Solo Baffle/anchor, installed at 300 mm centres	2,8/m ²	2,8/m ²
2	Connect Baffle wall fixing	2/panel	2/panel
	$\Delta 1$ Min. overall depth of system: $\Delta 1$ 212mm / 312mm	-	-
	$\Delta 2$ Min. overall depth of system: $\Delta 2$ 20mm	-	-
	$\Delta 3$ Min. overall depth of system: $\Delta 3$ 2500mm	-	-

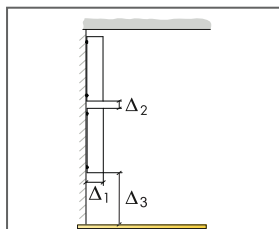

Fixing of Connect Profile connector

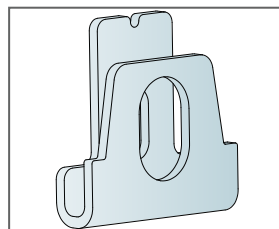

Fixing of Connect Profile connector

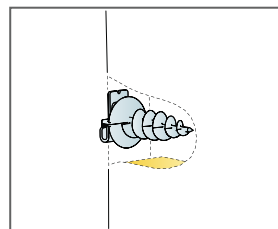

Fixing of Connect Profile connector

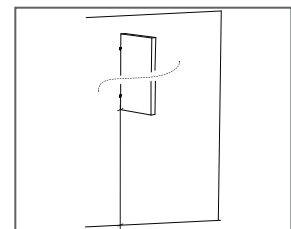

Fixing of Connect Profile connector

Ecophon Solo™ Textile

Solo Textile is a panel fully covered in textile fabric, available in a range of colours. The premium free-hanging unit combines high acoustic performance with elegance and design. Solo Textile entices the senses, contributing to a full sensory experience.



Solo Textile 2020, United Kingdom

SYSTEM RANGE

<input type="checkbox"/>	Size, mm	1200x1200
	Special Fixing	•
	Thickness	40
	Inst. Diagr.	M482



Suspension with Connect Adjustable wire hanger and Connect Absorber anchor



Solo Textile pre-cut hole

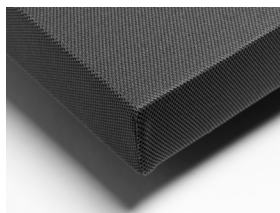

Solo Textile corner

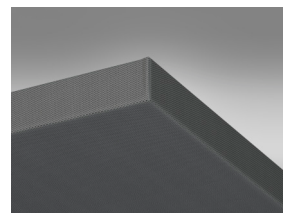

Solo Textile panel

Acoustic



The values in the diagram refer to a single unit. If the units are arranged in a cluster with distances between units less than 0,5 meters, the Aeq per unit will be slightly reduced.

Sound Absorption:

Test results according to EN ISO 354.

A_{eq}, Equivalent absorption area per unit (m² sabin)

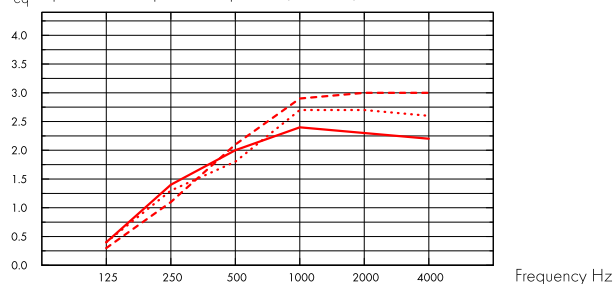

- Solo Textile 1200x1200, 200 mm o.d.s.
 - ⋯ Solo Textile 1200x1200, 400 mm o.d.s.
 - - - Solo Textile 1200x1200, 1000 mm o.d.s.
- o.d.s = overall depth of system

	THK mm	o.d.s. mm	A _{eq} , Equivalent absorption area per unit (m ² sabin)					
			125 Hz	250 Hz	500 Hz	1000 Hz	2000 Hz	4000 Hz
1200x1200	40	200	0.4	1.4	2.0	2.4	2.3	2.2
1200x1200	40	400	0.4	1.3	1.8	2.7	2.7	2.6
1200x1200	40	1000	0.3	1.1	2.1	2.9	3.0	3.0

Indoor Air Quality



Certificate / Label

Eurofins Indoor Air Comfort®

IAC Gold

French VOC

A+



Circularity



Fully recyclable.

Fire safety



Country

Fire standard

Class

See table

Europe

EN 13501-1

B-s1,d0

Humidity Resistance



Class A, relative humidity 70% and 25°C, according to EN 13964:2014



Visual appearance

Light reflectance and nearest NCS colour sample for all the different colours: See Ecophon Colours and surfaces. (The tiles need to be installed in accordance with the installation guide in order to get optimal visual appearance).



Cleanability

Weekly dusting and vacuum cleaning



Accessibility

The tiles are demountable.



Installation

Installed according to installation diagrams, installation guides and drawing aid. For information regarding minimum overall depth of system see quantity specification.



System weight

Approximately 7 kg.



Mechanical properties

No additional live load is allowed.



CE

Ecophon ceiling systems are CE marked according to the European harmonized standard EN13964:2014. CE marked construction products are covered by a Declaration of Performance (DOP) which enables customers and users to easily compare performance of products available on the European market.

INSTALLATION DIAGRAM (M482) FOR ECOPHON SOLO TEXTILE

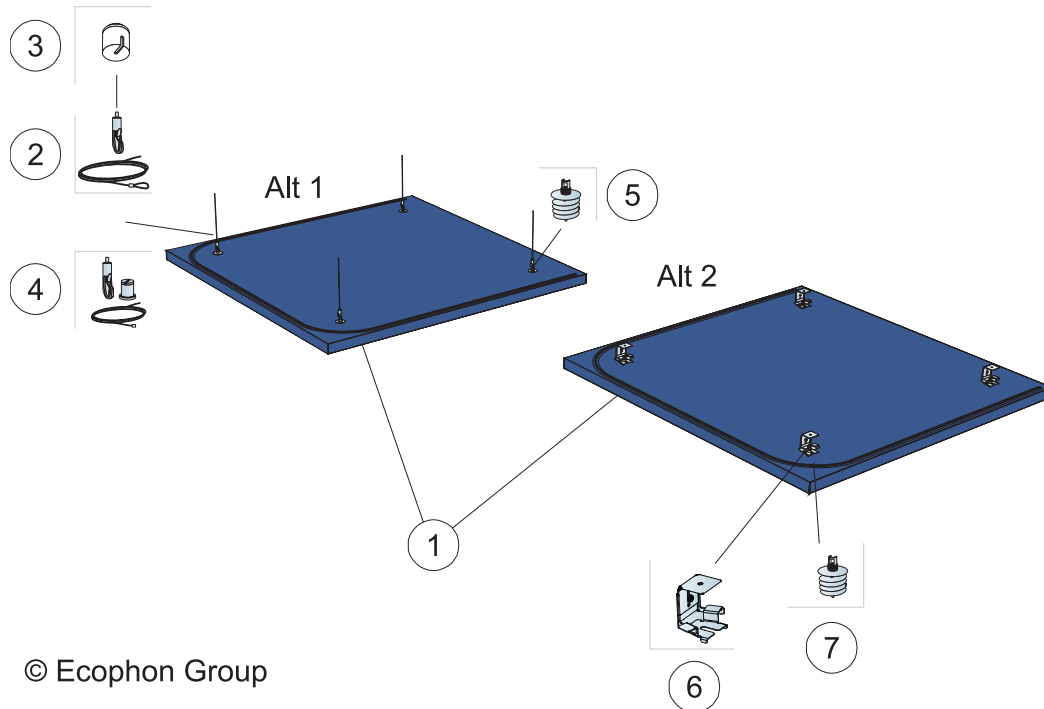

© Ecophon Group

QUANTITY SPECIFICATION (EXCL. WASTAGE)

		Size, mm
		1200x1200
1	Solo Textile	1,44m ² /panel
2	Connect Adjustable wire hanger (Alt 1)	4/panel
3	Connect Covering cup (Alt 1, Optional)	4/panel
4	Connect Adjustable wire kit (Alt 1, Optional)	4/panel
5	Connect Absorber anchor (Alt 1)	4/panel
6	Connect Absorber bracket (Alt 2)	4/panel
7	Connect Absorber anchor (Alt 2)	4/panel
Δ Min. overall depth of system: Δ1 140 mm / Δ2 90 mm		-

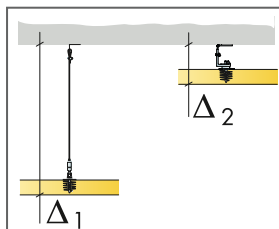

See Quantity specification

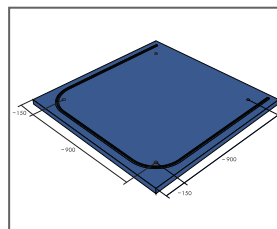

Installation dimensions

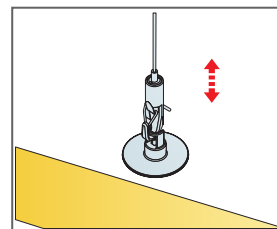

Easily adjustable suspension with Connect Adjustable wire hanger

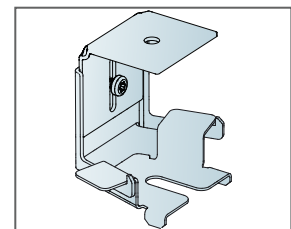

Ecophon Solo™ Matrix

The system provides quick and easy installation with highest accuracy and a vast range of design possibilities. Each panel has a built in hatch function, and can easily be demounted. Suitable for larger areas where high coverage is required but a wall to wall solution is not possible.



SYSTEM RANGE

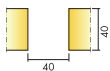

Size, mm	600x1040	600x1200	600x2400	1200x1040	1200x1200	2400x1040	2400x1200
T24	•	•	•	•	•	•	•
Thickness	40	40	40	40	40	40	40
Inst. Diagr.	M502	M501, M503	M501, M503	M502	M501	M502	M501

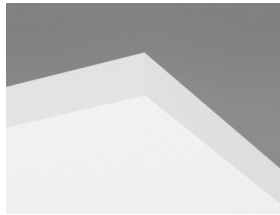

Solo Matrix panel

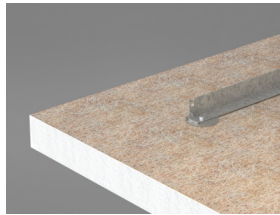

Connect Panel Cross Bar on rear side of Solo Matrix panel

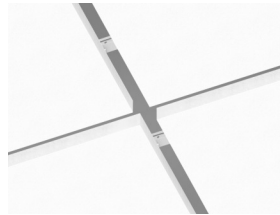

Solo Matrix system

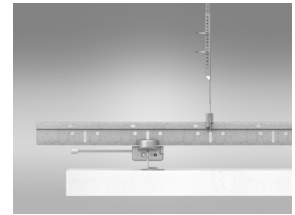

Section of Solo Matrix system

Acoustic



The first diagram refers to clusters >10 m². The second diagram to a cluster of four panels (1200x1040 mm) in a row with a distance of 40 mm (M502). If the clusters are arranged with distances between the clusters <0,5 meters, the Aeq per cluster will be slightly reduced.

Sound Absorption:

Test results according to EN ISO 354. Classification according to EN ISO 11654.

α_p , Practical sound absorption coefficient

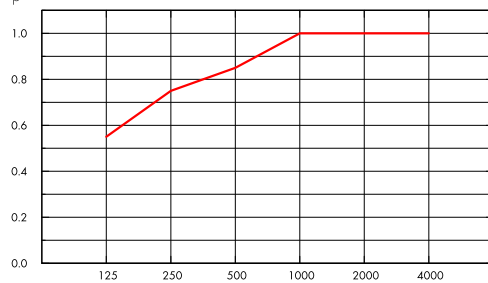

— Solo Matrix 40 mm, 300 mm o.d.s.
o.d.s = overall depth of system

A_{eq} , Equivalent absorption area per unit (m² sabin)

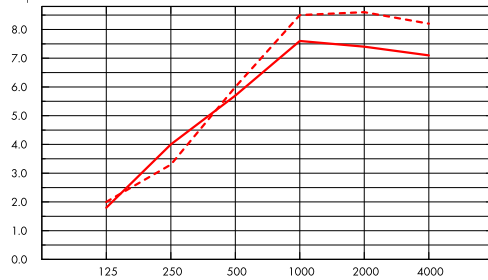

— Solo Matrix 40 mm (M502), 300 mm o.d.s.
- - - Solo Matrix 40 mm (M502), 600 mm o.d.s.
o.d.s = overall depth of system

THK mm	o.d.s. mm	α_p , Practical sound absorption coefficient						α_w	Sound absorption class
		125 Hz	250 Hz	500 Hz	1000 Hz	2000 Hz	4000 Hz		
40	300	0.55	0.75	0.85	1.00	1.00	1.00	0.95	A

THK mm	o.d.s. mm	A_{eq} , Equivalent absorption area per unit (m ² sabin)					
		125 Hz	250 Hz	500 Hz	1000 Hz	2000 Hz	4000 Hz
40	300	1.8	4.0	5.7	7.6	7.4	7.1
40	600	2.0	3.3	6.0	8.5	8.6	8.2
40	1000	2.1	3.5	6.4	9.1	9.2	9.0



Indoor Air Quality

Certificate / Label	
Eurofins Indoor Air Comfort®	IAC Gold
French VOC	A+



Cradle to Cradle Certified®



This product is Cradle to Cradle Certified® at Bronze level (version 4.0).



Material Health

This product has received a C2C Certified Material Health Certificate™ at the Silver level (standard version 4.0). The C2C Certified Material Health Certificate™ is a verification of the health and safety of a product's composition using the Material Health requirements of the Cradle-to-Cradle Certified Product Standard.



Carbon footprint

	kg CO ₂ equiv./m ²	Life-cycle stages A1 to C4 from EPD, in conformity with ISO 14025 / EN 15804
Solo Matrix	7,52	



Circularity

Minimum post-consumer recycled content	62%
Recyclability	Fully recyclable



Fire safety

Country	Fire standard	Class
Europe	EN 13501-1	A2-s1,d0

The glass wool core of the tiles is tested and classified as non-combustible according to EN ISO 1182.



Humidity Resistance

Class C, relative humidity 95% and 30°C, according to EN 13964:2014



Visual appearance

White Frost, nearest NCS colour sample S 0500-N, 85% light reflectance. Gloss < 1.



Cleanability

Daily dusting and vacuum cleaning. Weekly wet wiping.



Accessibility

Each panel is individually demountable from below. Panels are equipped with hatch function.



Installation

For design possibilities including installation direction and integrations, see installation guides, installation diagrams and drawing aid. For information regarding minimum overall depth of system see quantity specification.



System weight

	kg/m ²	Weight information is indicative and subject to variation.
Solo Matrix	3,5	
Solo Matrix + Connect Grid System	4,5	



Mechanical properties

The panels can take small loads with largest aperture diameter of 100 mm. The load is restricted to maximum 250g between two Panel cross bars. For heavier loads see Installation guide.



CE

Ecophon ceiling systems are CE marked according to the European harmonized standard EN13964:2014. CE marked construction products are covered by a Declaration of Performance (DOP) which enables customers and users to easily compare performance of products available on the European market.

INSTALLATION DIAGRAM (M501) FOR ECOPHON SOLO MATRIX IN MODULES

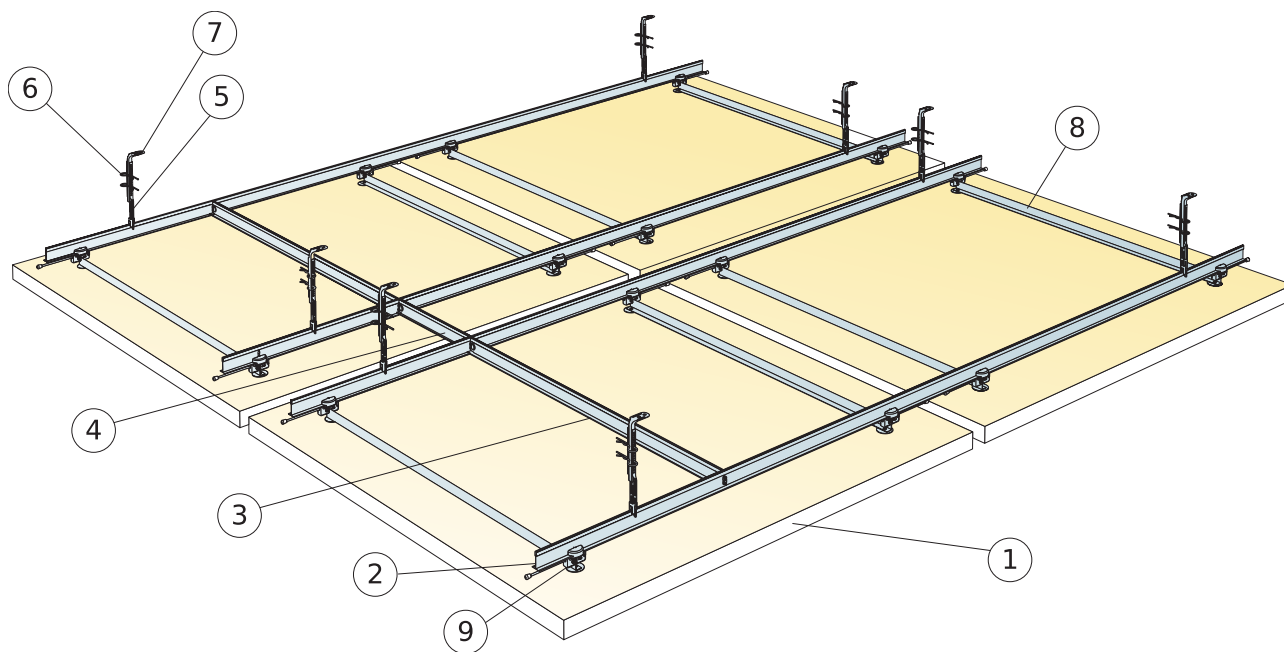

© Ecophon Group

QUANTITY SPECIFICATION (EXCL. WASTAGE)

	Size, mm			
	600x1200	600x2400	1200x1200	2400x1200
1 Solo Matrix	0,72m ² / tile	1,44m ² / tile	1,44m ² / tile	2,88m ² / tile
2 Connect T24 Main runner, installed with spacing 900 mm and 300 mm	1,67m ² /m ²	1,67m ² /m ²	1,67m ² /m ²	1,67m ² /m ²
3 Connect T24 Cross tee, L=900 mm, installed with spacing 1800 mm	0,42m ² /m ²	0,42m ² /m ²	0,42m ² /m ²	0,42m ² /m ²
4 Connect T24 Cross tee, L=300 mm, installed with spacing 2400 mm	0,11m ² /m ²	0,11m ² /m ²	0,11m ² /m ²	0,11m ² /m ²
5 Connect Nonius Hanger Lower, installed with spacing 1800 mm	0,95/m ²	0,95/m ²	0,95/m ²	0,95/m ²
6 Connect Split pin 0078 (2/hanger)	1,9/m ²	1,9/m ²	1,9/m ²	1,9/m ²
7 Connect Nonius hanger upper, installed with spacing 1800 mm	0,95/m ²	0,95/m ²	0,95/m ²	0,95/m ²
8 Connect Panel cross bar	2/panel	4/panel	2/panel	3/panel
9 Connect Panel connector	4/panel	8/panel	4/panel	6/panel
Δ Min. overall depth of system: 305 mm	-	-	-	-
Quantity specification based on 40 mm gap between all panels	-	-	-	-
Stabilization could be required, see installation guide for more details	-	-	-	-

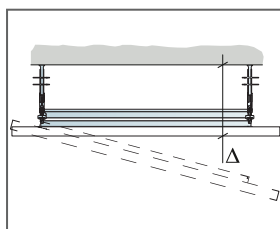

See Quantity Specification

Modular size	Exact size
600x1200	560x1160
600x2400	560x2360
1200x1200	1160x1160
2400x1200	2360x1160

The left column shows modular sizes and the right exact panel sizes.

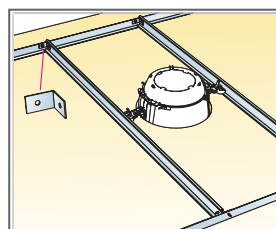

For heavier integrations use Connect Cross Tee and Connect Angle Bracket.

Size, mm	Max live load [N]	Min load bearing capacity [N]
600x1200x40	5	160
600x2400x40	5	160
1200x1200x40	5	160
2400x1200x40	5	160

Live load/load bearing capacity

INSTALLATION DIAGRAM (M502) FOR ECOPHON SOLO MATRIX IN ROWS

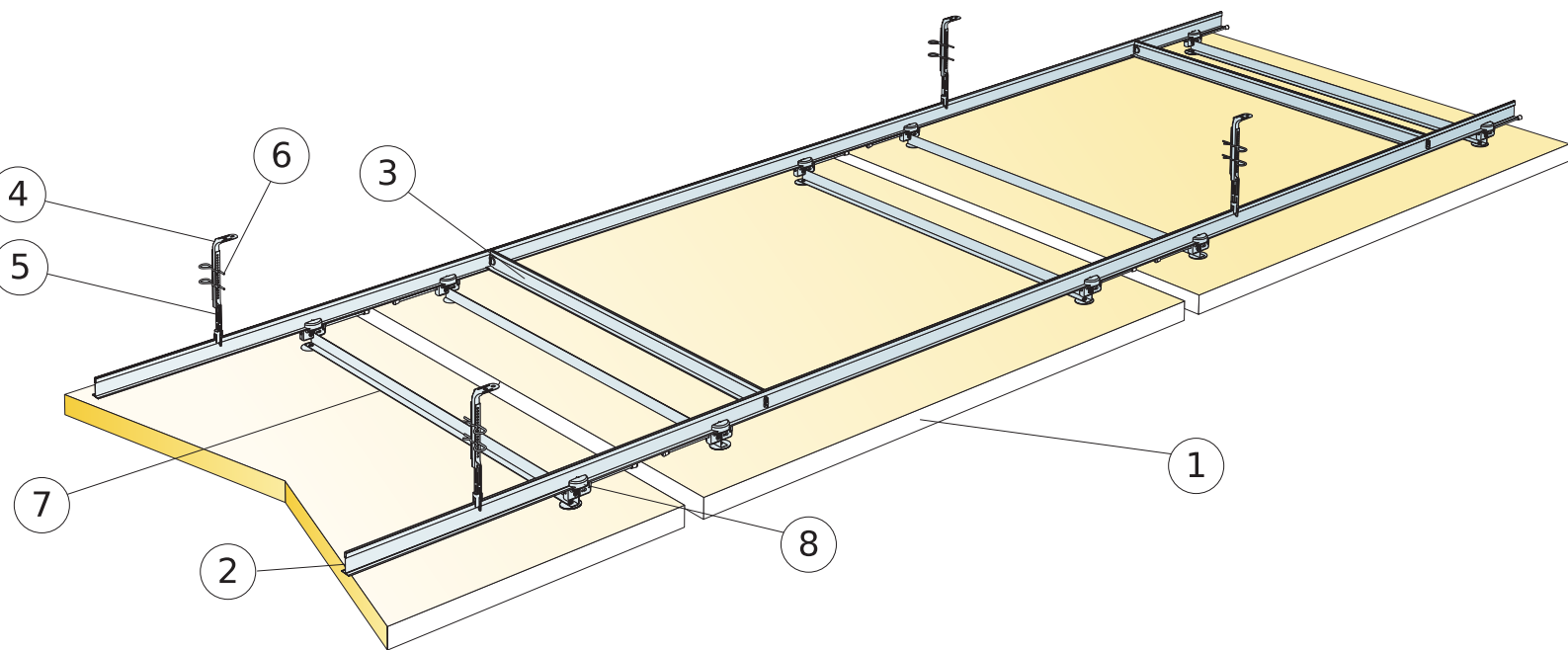

© Ecophon Group

QUANTITY SPECIFICATION (EXCL. WASTAGE)

	Size, mm		
	600x1040	1200x1040	2400x1040
1 Ecophon Master Matrix in rows	0,63m ² /panel	1,25m ² /panel	2,50m ² /panel
2 Connect T24 Main runner, installed with spacing 900 mm	1,93m/m ²	1,93m/m ²	1,93m/m ²
3 Connect T24 Cross tee, L=900 mm, installed with spacing 1800 mm	0,49m/m ²	0,49m/m ²	0,49m/m ²
4 Connect Nonius hanger upper, installed with spacing 1800 mm	1,07/m ²	1,07/m ²	1,07/m ²
5 Connect Nonius Hanger Lower, installed with spacing 1800 mm	1,07/m ²	1,07/m ²	1,07/m ²
6 Connect Split pin 0078 (2/hanger)	2,14/m ²	2,14/m ²	2,14/m ²
7 Connect Panel cross bar	2/panel	2/panel	3/panel
8 Connect Panel connector	4/panel	4/panel	6/panel
Δ Min. overall depth of system: 305 mm	-	-	-
Quantity specification based on 40 mm gap between panels in installation direction	-	-	-
Stabilization could be required, see installation guide for more details	-	-	-

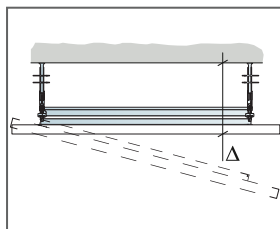

See Quantity Specification

Modular size	Exact size
600x1040	560x1000
1200x1040	1160x1000
2400x1040	2360x1000

The left column shows modular sizes and the right exact panel sizes.

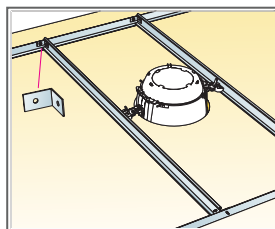

For heavier integrations use Connect Cross Tee and Connect Angle Bracket.

Size, mm	Max live load [N]	Min load bearing capacity [N]
600x1040x40	5	160
1200x1040x40	5	160
2400x1040x40	5	160

Live load/load bearing capacity

INSTALLATION DIAGRAM (M503) FOR ECOPHON SOLO MATRIX IN MODULES

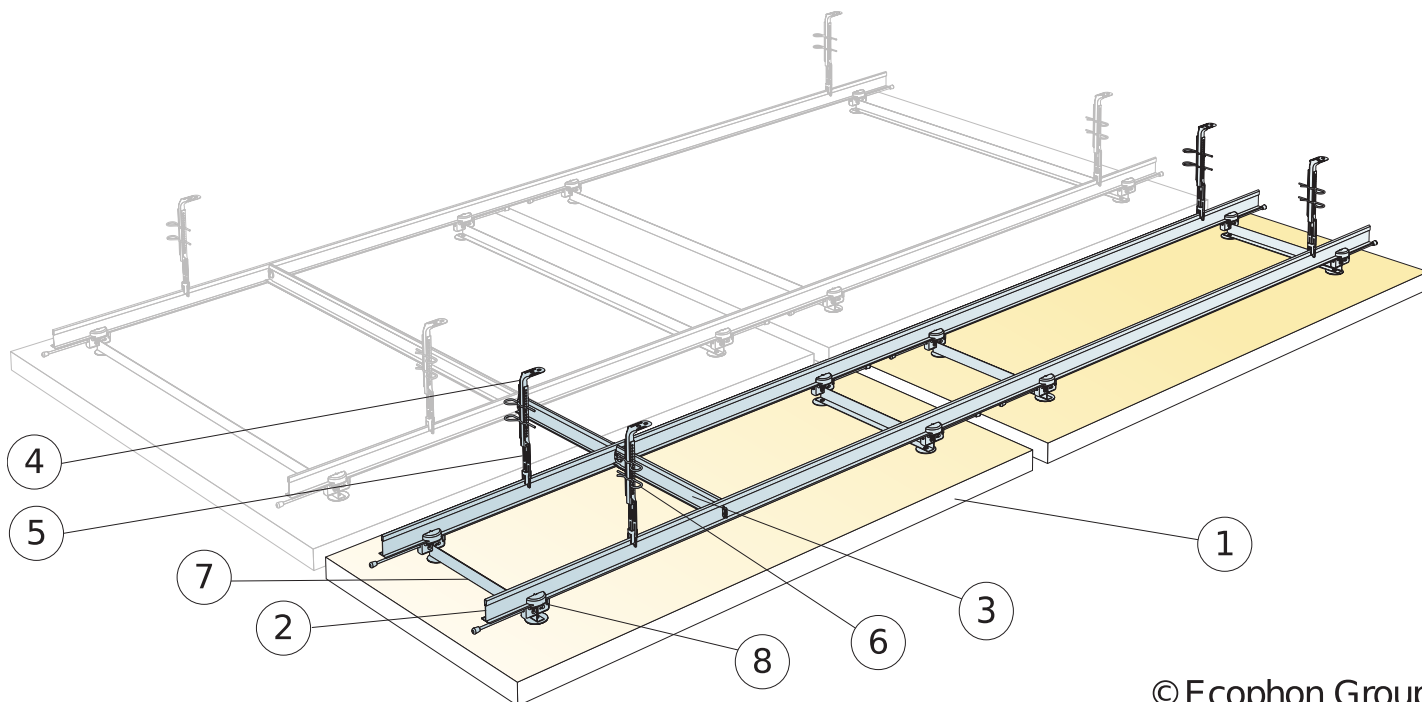

© Ecophon Group

QUANTITY SPECIFICATION (EXCL. WASTAGE)

	Size, mm	
	600x1200	600x2400
1 Solo Matrix	0,72m ² /panel	1,44m ² /panel
2 Connect T24 Main runner, installed with spacing 900 mm and 300 mm	1,67m/m ²	1,67m/m ²
3 Connect T24 Cross tee, L=300 mm, installed with spacing 2400 mm	0,11m/m ²	0,11m/m ²
4 Connect Nonius hanger upper, installed with spacing 1800 mm	0,95/m ²	0,95/m ²
5 Connect Nonius Hanger Lower, installed with spacing 1800 mm	0,95/m ²	0,95/m ²
6 Connect Split pin 0078 (2/hanger)	1,9/m ²	1,9/m ²
7 Connect Panel cross bar	2/panel	4/panel
8 Connect Panel connector	4/panel	8/panel
Δ Min. overall depth of system: 305 mm	-	-
Quantity specification based on 40 mm gap between all panels	-	-
Stabilization could be required, see installation guide for more details	-	-

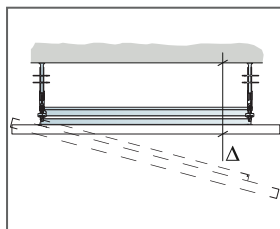

See Quantity Specification

Modular size	Exact size
600x1200	560x1160
600x2400	560x2360
1200x1200	1160x1160
2400x1200	2360x1160

The left column shows modular sizes and the right exact panel sizes.

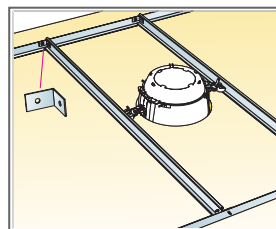

For heavier integrations use Connect Cross Tee and Connect Angle Bracket.

Size, mm	Max live load [N]	Min load bearing capacity [N]
600x1200x40	5	160
600x2400x40	5	160

Live load/load bearing capacity

Ecophon Solo™ Rectangle Line

Solo Rectangle Line is a free hanging unit with an integrated recessed luminaire. A combination of Ecophon Solo™ Rectangle and Ecophon Line™. This is a product suitable for various applications such as open plan solutions, lunch areas or conference and meeting areas.



Ecophon Head Office, Hylinge, Sweden

SYSTEM RANGE

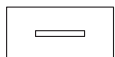

Size, mm	2400x1200
Special Fixing	•
Thickness	40
Inst. Diagr.	M521

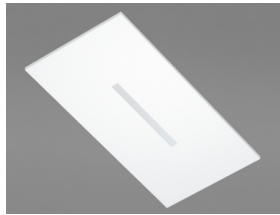

Solo Rectangle Line

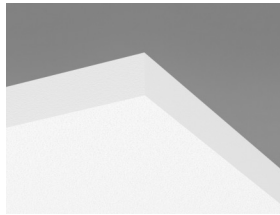

Solo panel

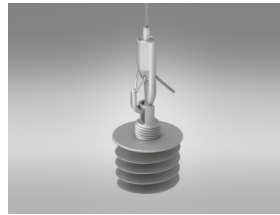

Suspension with Connect Adjustable wire hanger and Connect Absorber anchor

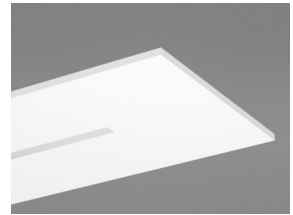

Solo panel with Line

Acoustic



For acoustic data on the panel - please see Solo Rectangle.



Lighting performance

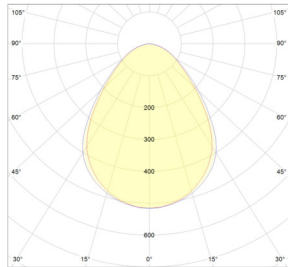

System effect: 29,4W
 Light source: LED 26,7 W
 Luminous flux: 2337 lm
 Light efficiency: 87,5 lm/W
 Colour temperature: 4000K
 Color rendering index: Ra ≥80
 Colour tolerance: MacAdam ≤3 SDCM
 Light output ratio (LOR): 100%
 Light distribution up/down: 0/100
 Expected lifespan: L90 >50 000 h
 Expected lifespan: L70 >100 000 h



Connection

The standard on/off electronic HF ballast delivered with 2,5 meters of cable 3x0,75 mm² and grounded plug. The SwitchDIM/DALI delivered without cable.



Electrical data

220-240 V, 50-60 Hz, power factor cos φ>0,98. Electronic HF ballast or electronic HF dim ballast for digital regulation.
Light source: led module of 26,7W total.



Electrical approvals

IP20, Class 1.



Circularity

Minimum post-consumer recycled content	57%
Recyclability	Fully recyclable



Fire safety

Country	Fire standard	Class
Europe	EN 13501-1	A2-s1,d0

The glass wool core of the tiles is tested and classified as non-combustible according to EN ISO 1182.



Humidity Resistance

Class A, relative humidity 70% and 25°C, according to EN 13964:2014



Visual appearance

White Frost, nearest NCS colour sample S 0500-N, 85% light reflectance. Gloss < 1.



Cleanability

Daily dusting and vacuum cleaning. Weekly wet wiping.



Accessibility

The tiles are demountable.



Installation

Installed according to installation diagrams, installation guides and drawing aid. For information regarding minimum overall depth of system see quantity specification.



CE

Ecophon ceiling systems are CE marked according to the European harmonized standard EN13964:2014. CE marked construction products are covered by a Declaration of Performance (DOP) which enables customers and users to easily compare performance of products available on the European market.

INSTALLATION DIAGRAM (M521) FOR ECOPHON SOLO RECTANGLE LINE

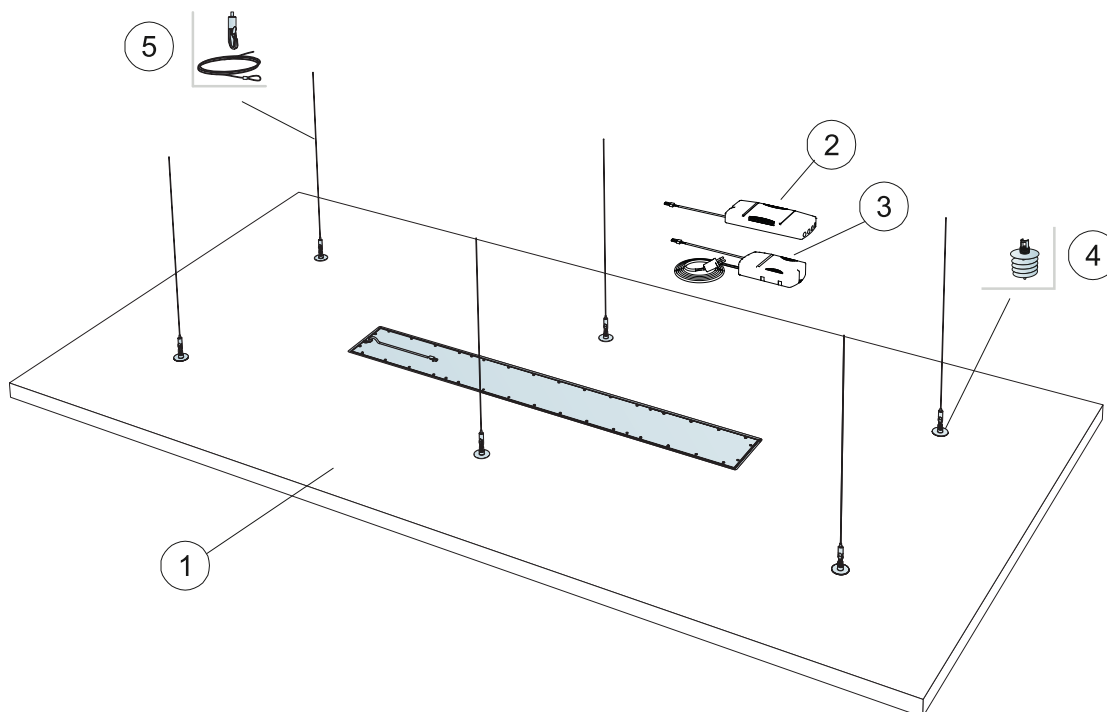

QUANTITY SPECIFICATION (EXCL. WASTAGE)

	Size, mm
	2400x1200
1 Solo Rectangle line	2,88/m ²
2 Ecophon Dot/Square/Line standard On/Off Ballast (included) [Alt.1]	-
3 Ecophon Dot/Square/Line SwitchDIM/DALI Ballast (included) [Alt.2]	-
4 Connect Absorber anchor	6/panel
5 Connect Adjustable wire hanger [Alt 1]	6/panel
Δ Min. overall depth of system: 140 mm	-
When selecting standard on/off ballast, connect only to a toggle power switch. When using the SwitchDIM/DALI ballast connecting the SwitchDIM function, use a spring loaded power switch.	-
When selecting the SwitchDIM/DALI ballast utilizing the DALI function, connect only to a DALI compatible controller.	-

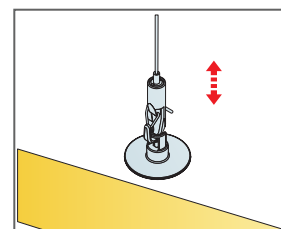
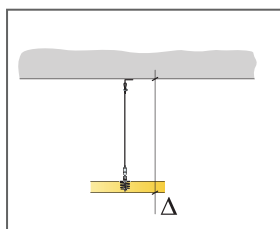

Easily adjustable suspension with Connect Adjustable wire hanger



Ecophon Solo™ Circle Akutex HS

Solo Circle Akutex HS is a water resistant free hanging unit, offering a high degree of design possibility. Solo Circle Akutex HS is primarily suited for swimming pool areas with high humidity and occasional direct water.



SYSTEM RANGE



Size, mm	Ø800	Ø1200
Special Fixing	•	•
Thickness	40	40
Inst. Diagr.	M437C4	M442C4



Solo Circle Akutex HS



Solo Circle Akutex HS tile

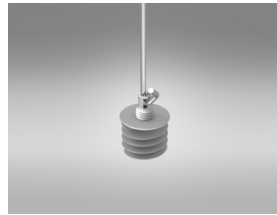

Suspension with Connect Adjustable Hanger C4 and Connect Absorber Anchor

Acoustic



The values in the diagram refer to a single unit. If the units are arranged in a cluster with distances between units less than 0,5 meters, the Aeq per unit will be slightly reduced.

Sound Absorption:

Test results according to EN ISO 354.

A_{eq} Equivalent absorption area per unit (m² sabin)

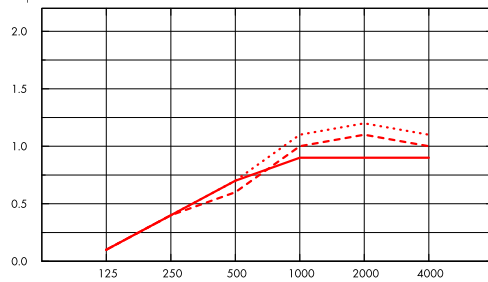

- Solo Circle/Akutex HS Ø800, 200 mm o.d.s.
 - - - Solo Circle/Akutex HS Ø800, 400 mm o.d.s.
 - · · Solo Circle/Akutex HS Ø800, 1000 mm o.d.s.
- o.d.s = overall depth of system

A_{eq} Equivalent absorption area per unit (m² sabin)

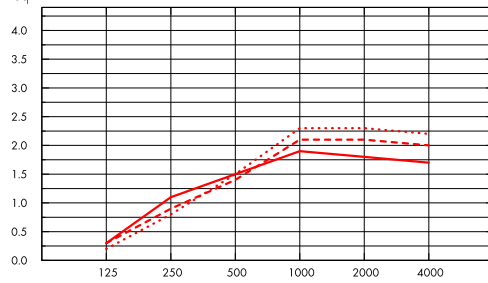

- Solo Circle/Akutex HS Ø1200, 200 mm o.d.s.
 - - - Solo Circle/Akutex HS Ø1200, 400 mm o.d.s.
 - · · Solo Circle/Akutex HS Ø1200, 1000 mm o.d.s.
- o.d.s = overall depth of system

	THK mm	o.d.s. mm	A _{eq} Equivalent absorption area per unit (m ² sabin)					
			125 Hz	250 Hz	500 Hz	1000 Hz	2000 Hz	4000 Hz
Ø800	40	200	0.1	0.4	0.7	0.9	0.9	0.9
Ø800	40	400	0.1	0.4	0.6	1.0	1.1	1.0
Ø800	40	1000	0.1	0.4	0.7	1.1	1.2	1.1

	THK mm	o.d.s. mm	A _{eq} Equivalent absorption area per unit (m ² sabin)					
			125 Hz	250 Hz	500 Hz	1000 Hz	2000 Hz	4000 Hz
Ø1200	40	200	0.3	1.1	1.5	1.9	1.8	1.7
Ø1200	40	400	0.3	0.9	1.4	2.1	2.1	2.0
Ø1200	40	1000	0.2	0.8	1.5	2.3	2.3	2.2



Indoor Air Quality

Certificate / Label	
Eurofins Indoor Air Comfort®	IAC Gold
French VOC	A+



Cradle to Cradle Certified®



This product is Cradle to Cradle Certified® at Bronze level (version 4.0).



Material Health

This product has received a C2C Certified Material Health Certificate™ at the Silver level (standard version 4.0). The C2C Certified Material Health Certificate™ is a verification of the health and safety of a product's composition using the Material Health requirements of the Cradle-to-Cradle Certified Product Standard.



Carbon footprint

	kg CO ₂ equiv/m ²	Life-cycle stages A1 to C4 from EPD, in conformity with ISO 14025 / EN 15804
Solo Circle/Akutex HS	10,87	



Circularity

Minimum post-consumer recycled content	54%
Recyclability	Fully recyclable



Fire safety

Country	Fire standard	Class
Europe	EN 13501-1	A2-s1,d0

The glass wool core of the tiles is tested and classified as non-combustible according to EN ISO 1182.



Humidity Resistance

Class C, relative humidity 95% and 30°C, according to EN 13964:2014



Visual appearance

White 500, nearest NCS colour sample S 0500-N, 84% light reflectance.



Cleanability

Daily dusting and vacuum cleaning. Weekly wet wiping.



Accessibility

The tiles are demountable.



Installation

Installed according to installation diagrams, installation guides and drawing aid. For information regarding minimum overall depth of system see quantity specification.



System weight

	kg/m ²	Weight information is indicative and subject to variation.
Solo Circle/Akutex HS	4,9	



Mechanical properties

No additional live load is allowed.



CE

Ecophon ceiling systems are CE marked according to the European harmonized standard EN 13964:2014. CE marked construction products are covered by a Declaration of Performance (DOP) which enables customers and users to easily compare performance of products available on the European market.

INSTALLATION DIAGRAM (M437C4) FOR ECOPHON SOLO™ CIRCLE AKUTEX HS C4

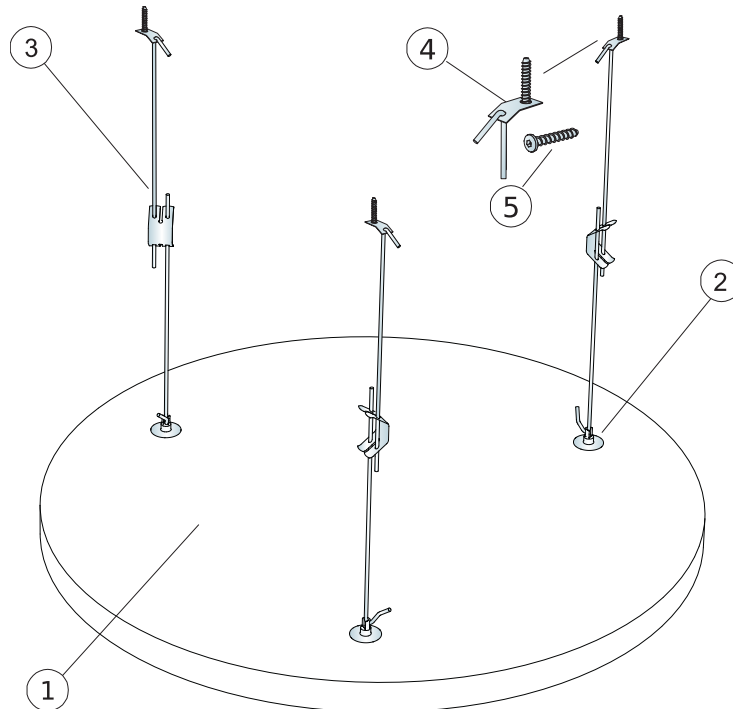

QUANTITY SPECIFICATION (EXCL. WASTAGE)

		Size, mm
		Ø800
1	Solo Circle Akutex HS	0,5m ² /panel
2	Connect Absorber anchor	3/panel
3	Connect Adjustable Hanger C4	3/panel
4	Connect Fixing plate C4	3/panel
5	Connect Anchor screw C4	3/panel
Δ Min. overall depth of system: Δ 410 mm		-

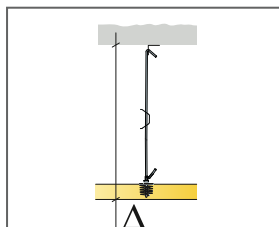

See Quantity specification

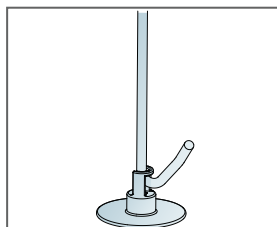

Connect Adjustable Hanger C4 mounted in Connect Absorber Anchor

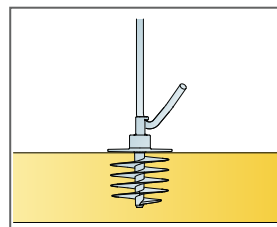

Connect Absorber Anchor mounted in panel

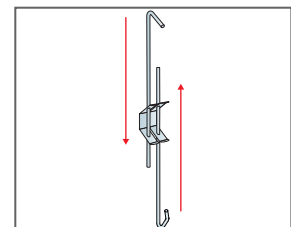

Adjustable suspension with Connect Adjustable Hanger C4

INSTALLATION DIAGRAM (M442C4) FOR ECOPHON SOLO™ CIRCLE AKUTEX HS C4

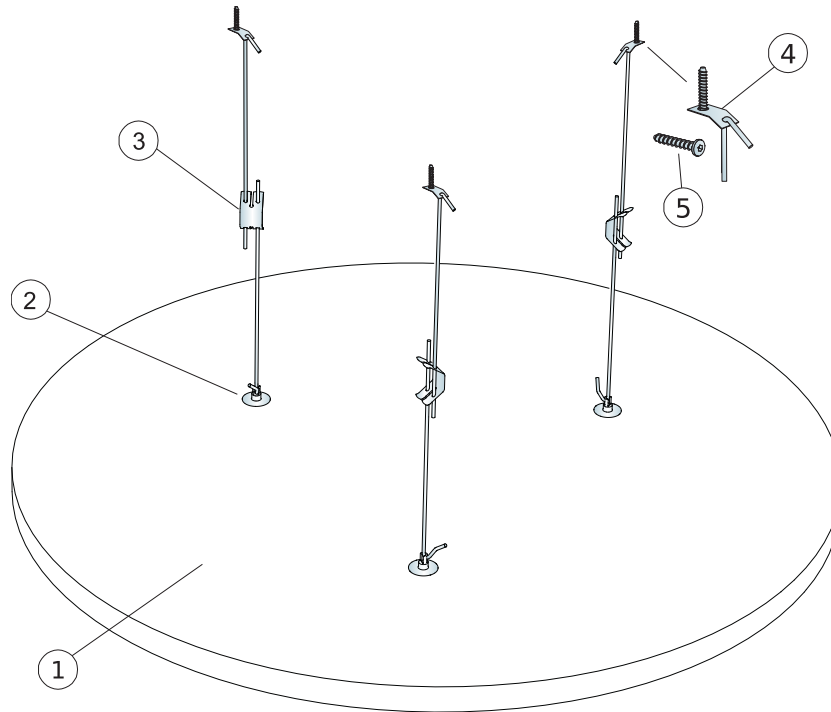

QUANTITY SPECIFICATION (EXCL. WASTAGE)

		Size, mm
		Ø1200
1	Solo Circle Akutex HS	1,13m ² /panel
2	Connect Absorber anchor	3/panel
3	Connect Adjustable Hanger C4	3/panel
4	Connect Fixing plate C4	3/panel
5	Connect Anchor screw C4	3/panel
Δ Min. overall depth of system: Δ 410 mm		-

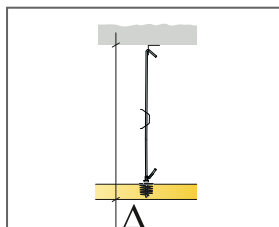

See Quantity specification

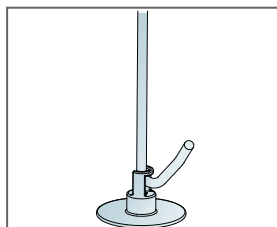

Connect Adjustable Hanger C4 mounted in Connect Absorber Anchor

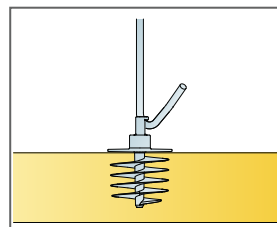

Connect Absorber Anchor mounted in panel

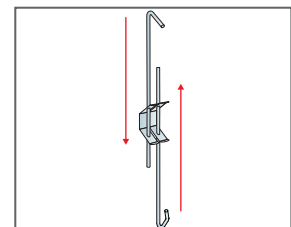

Adjustable suspension with Connect Adjustable Hanger C4



Ecophon Solo™ Square Akutex HS

Solo Square Akutex HS is a water resistant free hanging unit, offering a high degree of design possibility. Solo Square Akutex HS is primarily suited for swimming pool areas with high humidity and occasional direct water.



SYSTEM RANGE

<input type="checkbox"/>	Size, mm	1200x1200
	Special Fixing	•
	Thickness	40
	Inst. Diag.	M438C4

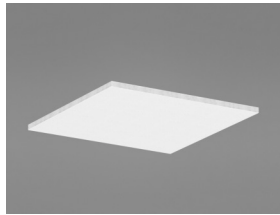

Solo Square Akutex HS

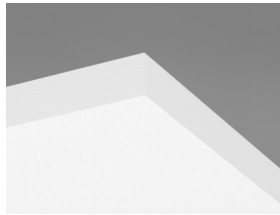

Solo Rectangle Akutex HS tile

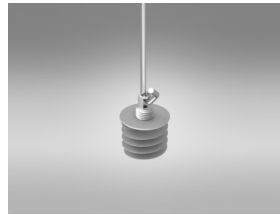

Suspension with Connect Adjustable Hanger C4 and Connect Absorber Anchor

Acoustic



The values in the diagram refer to a single unit. If the units are arranged in a cluster with distances between units less than 0,5 meters, the Aeq per unit will be slightly reduced.

Sound Absorption:

Test results according to EN ISO 354.

A_{eq}: Equivalent absorption area per unit (m² sabin)

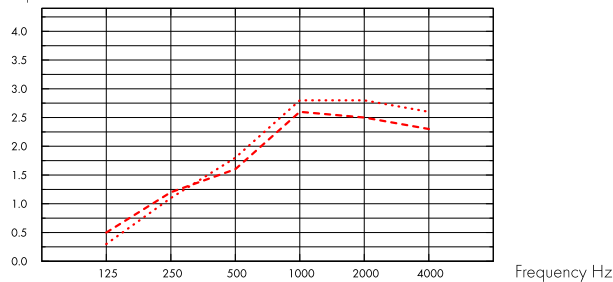

--- Solo Square 1200x1200/Akutex HS, 400 mm o.d.s.

.... Solo Square 1200x1200/Akutex HS, 1000 mm o.d.s.

o.d.s = overall depth of system

THK mm	o.d.s. mm	A _{eq} : Equivalent absorption area per unit (m ² sabin)					
		125 Hz	250 Hz	500 Hz	1000 Hz	2000 Hz	4000 Hz
40	400	0.5	1.2	1.6	2.6	2.5	2.3
40	1000	0.3	1.1	1.8	2.8	2.8	2.6

Indoor Air Quality



Certificate / Label

Eurofins Indoor Air Comfort®

IAC Gold

French VOC

A+



Cradle to Cradle Certified®



This product is Cradle to Cradle Certified® at Bronze level (version 4.0).



Material Health

This product has received a C2C Certified Material Health Certificate™ at the Silver level (standard version 4.0). The C2C Certified Material Health Certificate™ is a verification of the health and safety of a product's composition using the Material Health requirements of the Cradle-to-Cradle Certified Product Standard.



Carbon footprint

	kg CO ₂ equiv/m ²
Solo Square	9,37

Life-cycle stages A1 to C4 from EPD, in conformity with ISO 14025 / EN 15804



Circularity

Minimum post-consumer recycled content	54%
Recyclability	Fully recyclable



Fire safety

Country	Fire standard	Class
Europe	EN 13501-1	A2-s1,d0

The glass wool core of the tiles is tested and classified as non-combustible according to EN ISO 1182.



Humidity Resistance

Class C, relative humidity 95% and 30°C, according to EN 13964:2014



Visual appearance

White 500, nearest NCS colour sample S 0500-N, 84% light reflectance.



Cleanability

Daily dusting and vacuum cleaning. Weekly wet wiping.



Accessibility

The tiles are demountable.



Installation

Installed according to installation diagrams, installation guides and drawing aid. For information regarding minimum overall depth of system see quantity specification.



System weight

	kg/m ²
Solo Square/Akutex HS	4,9

Weight information is indicative and subject to variation.



Mechanical properties

No additional live load is allowed.



CE

Ecophon ceiling systems are CE marked according to the European harmonized standard EN 13964:2014. CE marked construction products are covered by a Declaration of Performance (DOP) which enables customers and users to easily compare performance of products available on the European market.

INSTALLATION DIAGRAM (M438C4) FOR ECOPHON SOLO™ SQUARE AKUTEX HS C4

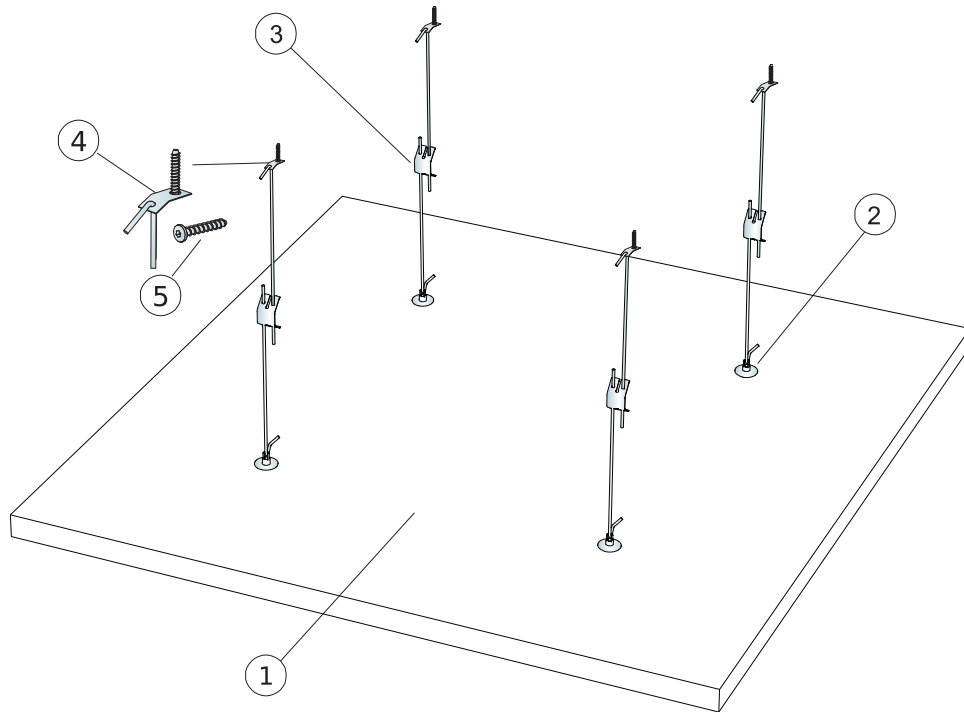

QUANTITY SPECIFICATION (EXCL. WASTAGE)

		Size, mm
		1200x1200
1	Solo Square Akutex HS	1,44m ² /panel
2	Connect Absorber anchor	4/panel
3	Connect Adjustable Hanger C4	4/panel
4	Connect Fixing plate C4	4/panel
5	Connect Anchor screw C4	4/panel
Δ Min. overall depth of system: Δ 410 mm		-

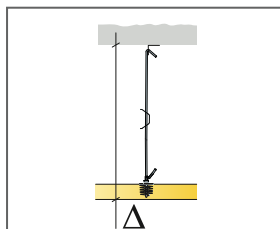

See Quantity specification

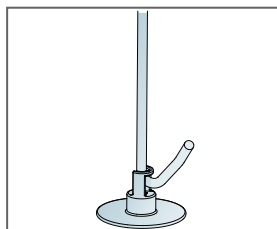

Connect Adjustable Hanger C4 mounted in Connect Absorber Anchor

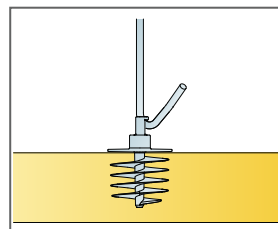

Connect Absorber Anchor mounted in panel

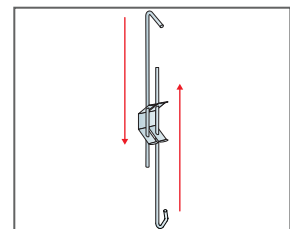

Adjustable suspension with Connect Adjustable Hanger C4



Ecophon Solo™ Rectangle Akutex HS

Solo Rectangle Akutex HS is a water resistant free hanging unit, offering a high degree of design possibility. Solo Rectangle Akutex HS is primarily suited for swimming pool areas with high humidity and occasional direct water.



SYSTEM RANGE

	Size, mm	1800x1200	2400x1200
	Special Fixing	•	•
	Thickness	40	40
	Inst. Diagr.	M436C4	M441C4

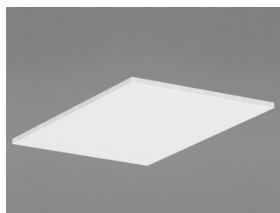

Solo Rectangle Akutex HS

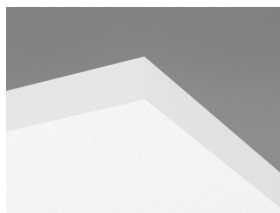

Solo Rectangle Akutex HS tile



Suspension with Connect Adjustable Hanger C4 and Connect Absorber Anchor

Acoustic



The values in the diagram refer to a single unit. If the units are arranged in a cluster with distances between units less than 0,5 meters, the Aeq per unit will be slightly reduced.

Sound Absorption:

Test results according to EN ISO 354.

A_{eq} Equivalent absorption area per unit (m² sabin)

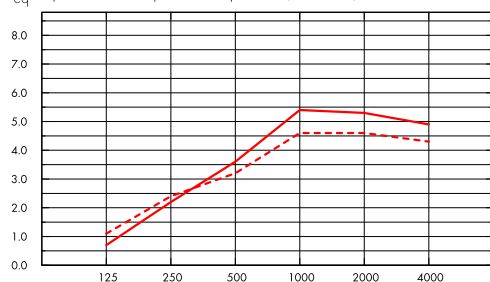

- Solo Rectangle 2400x1200/Akutex HS, 400 mm o.d.s.
 - Solo Rectangle 2400x1200/Akutex HS, 1000 mm o.d.s.
- o.d.s = overall depth of system

Frequency Hz

A_{eq} Equivalent absorption area per unit (m² sabin)

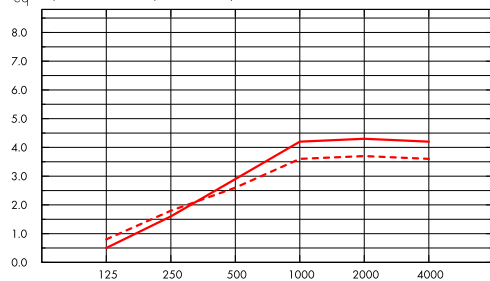

- Solo Rectangle 1800x1200/Akutex HS, 400 mm o.d.s.
 - Solo Rectangle 1800x1200/Akutex HS, 1000 mm o.d.s.
- o.d.s = overall depth of system

Frequency Hz

	THK mm	o.d.s. mm	A _{eq} Equivalent absorption area per unit (m ² sabin)					
			125 Hz	250 Hz	500 Hz	1000 Hz	2000 Hz	4000 Hz
2400x1200	40	400	1.1	2.4	3.2	4.6	4.6	4.3
2400x1200	40	1000	0.7	2.2	3.6	5.4	5.3	4.9
1800x1200	40	400	0.8	1.8	2.6	3.6	3.7	3.6
1800x1200	40	1000	0.5	1.6	2.9	4.2	4.3	4.2

Indoor Air Quality



Certificate / Label

Eurofins Indoor Air Comfort®

French VOC

IAC Gold

A+



Cradle to Cradle Certified®



This product is Cradle to Cradle Certified® at Bronze level (version 4.0).



Material Health

This product has received a C2C Certified Material Health Certificate™ at the Silver level (standard version 4.0). The C2C Certified Material Health Certificate™ is a verification of the health and safety of a product's composition using the Material Health requirements of the Cradle-to-Cradle Certified Product Standard.



Carbon footprint

	kg CO ₂ equiv/m ²	Life-cycle stages A1 to C4 from EPD, in conformity with ISO 14025 / EN 15804
Solo Rectangle	9,64	



Circularity

Minimum post-consumer recycled content	54%
Recyclability	Fully recyclable



Fire safety

Country	Fire standard	Class	The glass wool core of the tiles is tested and classified as non-combustible according to EN ISO 1182.
Europe	EN 13501-1	A2-s1,d0	



Humidity Resistance

Class C, relative humidity 95% and 30°C, according to EN 13964:2014



Visual appearance

White 500, nearest NCS colour sample S 0500-N, 84% light reflectance.



Cleanability

Daily dusting and vacuum cleaning. Weekly wet wiping.



Accessibility

The tiles are demountable.



Installation

Installed according to installation diagrams, installation guides and drawing aid. For information regarding minimum overall depth of system see quantity specification.



System weight

	kg/m ²	Weight information is indicative and subject to variation.
Solo Rectangle Akutex HS	4,9	



Mechanical properties

No additional live load is allowed.



CE

Ecophon ceiling systems are CE marked according to the European harmonized standard EN13964:2014. CE marked construction products are covered by a Declaration of Performance (DOP) which enables customers and users to easily compare performance of products available on the European market.

INSTALLATION DIAGRAM (M436C4) FOR ECOPHON SOLO™ RECTANGLE AKUTEX HS C4 1800X1200

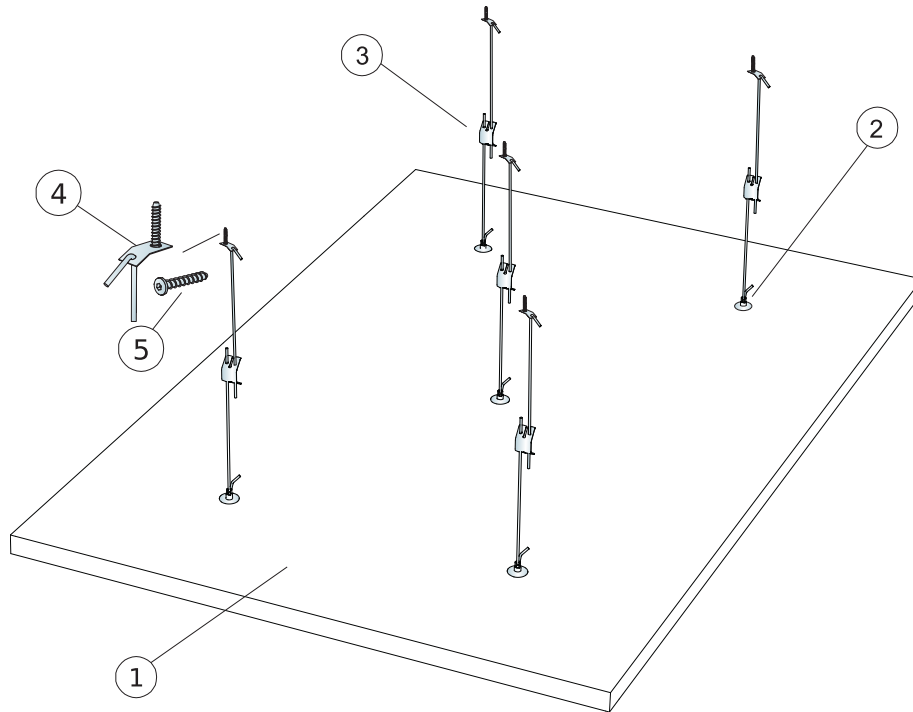

QUANTITY SPECIFICATION (EXCL. WASTAGE)

		Size, mm
		1800x1200
1	Solo Rectangle Akutex HS	2,16m ² /panel
2	Connect Absorber anchor	5/panel
3	Connect Adjustable Hanger C4	5/panel
4	Connect Fixing plate C4	5/panel
5	Connect Anchor screw C4	5/panel
Δ Min. overall depth of system: Δ 410 mm		-

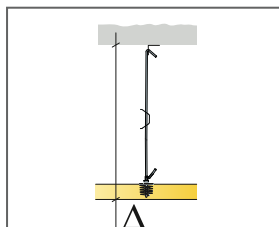

See Quantity specification

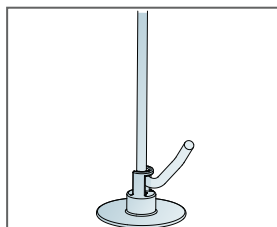

Connect Adjustable Hanger C4 mounted in Connect Absorber Anchor

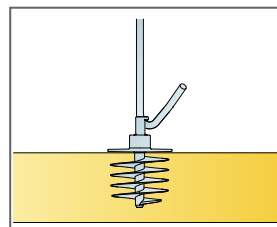

Connect Absorber Anchor mounted in panel

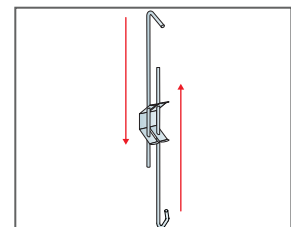

Adjustable suspension with Connect Adjustable Hanger C4

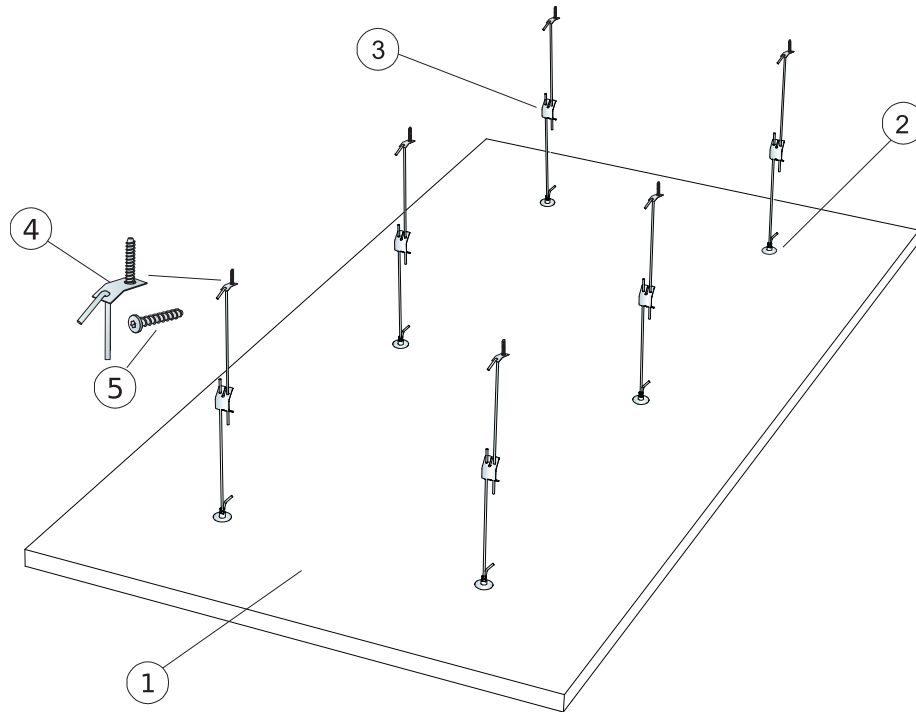

QUANTITY SPECIFICATION (EXCL. WASTAGE)

		Size, mm
		2400x1200
1	Solo Rectangle Akutex HS	2,88m ² /panel
2	Connect Absorber anchor	6/panel
3	Connect Adjustable Hanger C4	6/panel
4	Connect Fixing plate C4	6/panel
5	Connect Anchor screw C4	6/panel
Δ Min. overall depth of system: Δ 410 mm		-

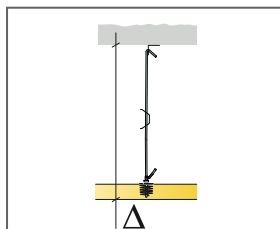

See Quantity specification

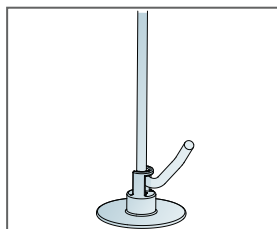

Connect Adjustable Hanger C4 mounted in Connect Absorber Anchor

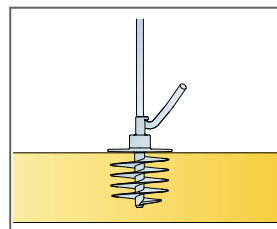

Connect Absorber Anchor mounted in panel

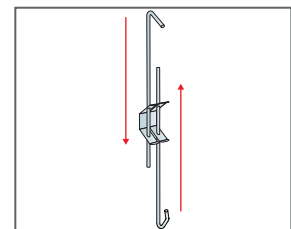

Adjustable suspension with Connect Adjustable Hanger C4