

Ecophon Hygiene Clinic™ A

Süsteemil Ecophon Hygiene Clinic™ A on nähtav liist, mis sobib kuivadesse piirkondadesse. Helineelduritel on väike emissioonitase, mis tagab kvaliteetse siseõhu. Need takistavad hallituse teket ja bakterite vohamist ning taluvad HPV-puhastust.

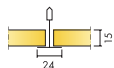

SÜSTEEMI INFO



Mõõdud, mm	600x600	1200x600
T24	•	•
Paksus (t)	15	15
Paigaldusjoonis	M338	M338



Hygiene Clinic A süsteemi seksioon



Hygiene Clinic A plaat



Hygiene Clinic A süsteem

Akustika



Heli neeldumine:

Testitulemused vastavalt: EN ISO 354. Klassifikatsioon vastavalt: EN ISO 11654.

α_p , Praktiline helineelduvustegur

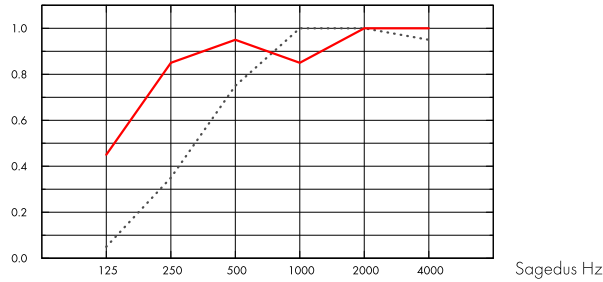

.... Hygiene Clinic A 15 mm, 50 mm o.d.s.

— Hygiene Clinic A 15 mm, 200 mm o.d.s.

o.d.s = üldine süsteemi sügavus

t mm	o.d.s. mm	α_p , Praktiline helineelduvustegur						α_w	Helineeldumisklass
		125 Hz	250 Hz	500 Hz	1000 Hz	2000 Hz	4000 Hz		
15	50	0.05	0.35	0.75	1.00	1.00	0.95	0.65	C
15	200	0.45	0.85	0.95	0.85	1.00	1.00	0.95	A

t mm	o.d.s. mm	NRC	SAA
15	50	0.80	0.79
15	200	0.90	0.91

Siseõhu kvaliteet



Sertifikaat / Märgis

Prantsusmaa LOÜ

Soome M1

A



Cradle to Cradle Certified®



Sellel tootel on pronks taseme Cradle to Cradle Certified® sertifikaat (versioon 4.0).



Material Health

See toode on saanud C2C Certified Material Health Certificate™ hõbedase taseme (standardversioon 4.0). C2C Certified Material Health Certificate™ on toote koostise tervise ja ohutuse kinnitus, kasutades Cradle-to-Cradle Certified Product Standardi Material Health nõudeid.



Süsiniku jalajälg

	kg CO ₂ equiv/m ²	Elutsükli etapid A1 kuni C4 EPD-st, vastavalt standardile ISO 14025 / EN 15804
Hygiene Clinic A	2,55	



Taaskasutus

Minimaalne tarbijajärgne taaskasutatud materjal	46%
Taaskasutus	Täielikult taaskasutatav



Tuleohutus

Riik	Tulestandard	Klass	Toote klaasvillast põhiplaati on testitud ja klassifitseeritud kui mittepõlev vastavalt EN ISO 1182.
Euroopa	EN 13501-1	A2-s1,d0	



Niiskuskindlus

Testitud C-klassi puhul, suhteline õhuniiskus 95% ja 30°C, vastavalt EN 13964:2014



Valguspeegeldus

White 500, lähim NCS värvinäidis S 0500-N, 84% valguspeegeldus.



Puhastatavus

Standard/meetod	Frequency
Tolmu pühkimine	Igapäevane
Märgpuhastus	Igapäevane
Vesinikperoksiidi aur	•
UV-C, BIFMA HCF 8.1-2019	•



Hallituse- ja bakteriresistentsus

Standard/meetod	Klass
ISO 846 :2019 meetod A (seente jaoks)	0 (Mikroskoobi all ei ole kasvu)
ISO 846 :2019 meetod C (bakteri jaoks)	0 (Mikroskoobi all ei ole kasvu)
ASTM D3273-16 (seente jaoks)	10 (0% kasv pinnal)



Puhasruum

	Standard/meetod	Klass
ISO 14644	Osakeste puhtuse klass	ISO 4
NF S 90-351	Mikrobioloogiline klass	M1/area 4
NF S 90-351	Osakeste kõrvaldamise kineetika	CP(0,5) 5



Avatavus

Plaadid on kergesti avatavad. Minimaalne avamise kõrgus vastavalt paigaldusjoonistele.



Paigaldus

Paigaldus vastavalt paigaldusjoonistele, -juhenditele ja Drawing Aid järgi. Infot minimaalse süsteemi paigalduskõrguse kohta vaata koguste spetsifikatsioonist.



Süsteemi kaal

	kg/m ²
Hygiene Clinic A	1,3
Hygiene Clinic A + Connect grid system	2,3

Kaalu teave on indikatiivne ja võib muutuda.



Mehaanilised omadused

Infot Max punktikoormuse ja Min koormuskandevõime kohta vaata tabelist; tehnilisi tingimusi ja mehaanilisi omadusi vaata www.ecophon.ee.



CE

Ecophoni laesüsteemid on CE-märgisega vastavalt Euroopa standardile EN13964:2014. CE-märgisega ehitustooted on hõlmatud toimumisdeklaratsiooniga (Declarations of Performance - DOP), mis võimaldab klientidel ja kasutajatel kergesti võrrelda Euroopa turul olevaid tooteid.

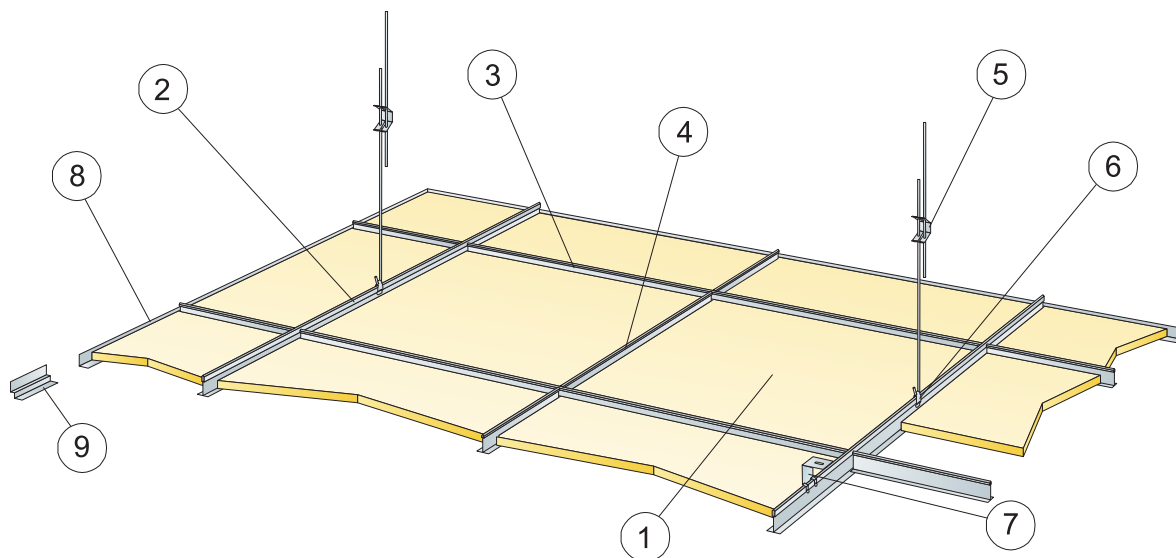

©Saint-Gobain Ecophon AB

KOGUSTE SPETSIFIKATSIOON (VALEMI JÄRGI)

	Mõõdud, mm	
	600x600	1200x600
1 Hygiene Clinic A	2,8/m ²	1,4/m ²
2 Connect T24 kandur, paigaldus 1200 mm tagant	0,9m/m ²	0,9m/m ²
3 Connect T24 vaheliist, L=1200 mm, paigaldus 600 mm tagant	1,7m/m ²	1,7m/m ²
4 Connect T24 vaheliist, L=600 mm	0,9m/m ²	-
5 Connect reguleeritav riputi, paigaldus 1200 mm tagant (max kaugus seinast 600 mm)	0,7/m ²	0,7/m ²
6 Connect riputi klips (mitte kasutada ujula keskkonnas)	0,7/m ²	0,7/m ²
7 Otsekinnituseks: Connect jäik kinniti, paigaldus 1200 mm tagant	0,7/m ²	0,7/m ²
8 Connect L-servaliist, kinnitus 300 mm tagant	vastavalt vajadusele	
9 Connect topel-L servaliist, kinnitus 300 mm tagant	vastavalt vajadusele	
Δ Min. süsteemi paigalduskõrgus, koos reguleeritava riputiga: 100 mm, jäiga kinnitiga: 50 mm.	-	-
δ Min. avamise kõrgus: 120 mm	-	-



Vaata koguste spetsifikatsiooni

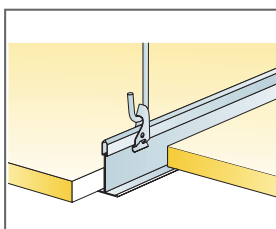

Riputus Connect reguleeritava riputi ja Connect klipsiga

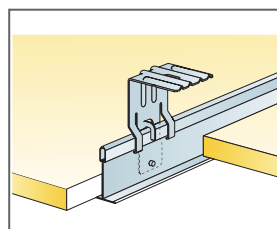

Riputus Connect jäiga kinnitiga

Mõõdud, mm	Max punktkoormus [N]	Max punktkoormuse kestvus [N]
600x600x15	50	160
1200x600x15	50	160

Punktkoormus/Punktkoormuse kestvus

Ecophon Hygiene Clinic™ E

Süsteemil Ecophon Hygiene Clinic™ E on nähtav süvistatud liist ja astmega servakujundus, mis sobib kuivadele piirkondadele. Helineelduritel on väike emissioonitase, mis tagab kvaliteetse siseõhu. Need takistavad hallituse teket ja bakterite vohamist ning taluvad HPV-puhastust.



Centre de dialyse de Pau

SÜSTEEMI INFO

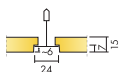

Mõõdud, mm	600x600	1200x600
T24	•	•
Paksus (t)	15	15
Paigaldusjoonis	M339	M339



Hygiene Clinic E plaat

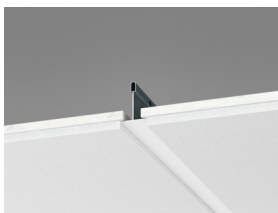

Hygiene Clinic E süsteemi sektsioon



Hygiene Clinic E süsteem

Akustika



Heli neeldumine:

Testi tulemused vastavalt: EN ISO 354.

Klassifikatsioon vastavalt: EN ISO 11654, ja üksikute väärtuste hinnangud NRC ja SAA kohta (Noise Reduction Coefficient ja Sound Absorption Average), vastavalt: ASTM C 423.

α_p , Praktiline helineelduvustegur

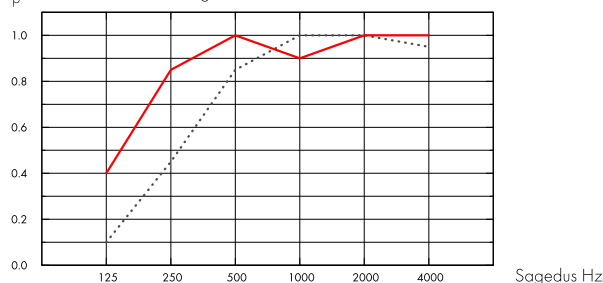

..... Hygiene Clinic E 15 mm, 60 mm o.d.s.

— Hygiene Clinic E 15 mm, 200 mm o.d.s.

o.d.s = üldine süsteemi sügavus

t mm	o.d.s. mm	α_p , Praktiline helineelduvustegur						α_w	Helineeldumisklass
		125 Hz	250 Hz	500 Hz	1000 Hz	2000 Hz	4000 Hz		
15	60	0.10	0.45	0.85	1.00	1.00	0.95	0.75	C
15	200	0.40	0.85	1.00	0.90	1.00	1.00	1.00	A



Siseõhu kvaliteet

Sertifikaat / Märkis

Prantsusmaa LOÜ

A

Soome M1



Cradle to Cradle Certified®



Sellel tootel on pronks taseme Cradle to Cradle Certified® sertifikaat (versioon 4.0).



Material Health

See toode on saanud C2C Certified Material Health Certificate™ hõbedase taseme (standardversioon 4.0). C2C Certified Material Health Certificate™ on toote koostise tervise ja ohutuse kinnitus, kasutades Cradle-to-Cradle Certified Product Standardi Material Health nõudeid.



Süsiniku jalajalg

	kg CO ₂ equiv/m ²
Hygiene Clinic E	2,19

Elutsükli etapid A1 kuni C4 EPD-st, vastavalt standardile ISO 14025 / EN 15804



Taaskasutus

Minimaalne tarbijajõrgne taaskasutatud materjal	45%
Taaskasutus	Täielikult taaskasutatav



Tuleohutus

Riik	Tulestandard	Klass
Euroopa	EN 13501-1	A2-s1,d0

Toote klaasvillast põhiplaati on testitud ja klassifitseeritud kui mittepõlev vastavalt EN ISO 1182.



Niiskuskindlus

Testitud C-klassi puhul, suhteline õhuniiskus 95% ja 30°C, vastavalt EN 13964:2014



Valguspeegeldus

White 500, lähim NCS värvinäidis S 0500-N, 84% valguspeegeldus.



Puhastatavus

Standard/meetod	Frequency
Tolmu pühkimine	Igapäevane
Märgpuhastus	Igapäevane
Vesinikperoksiidi aur	•
UV-C, BIFMA HCF 8.1-2019	•



Hallituse- ja bakteriresistentsus

Standard/meetod	Klass
ISO 846 :2019 meetod A (seente jaoks)	0 (Mikroskoobi all ei ole kasvu)
ISO 846 :2019 meetod C (bakteri jaoks)	0 (Mikroskoobi all ei ole kasvu)
ASTM D3273-16 (seente jaoks)	10 (0% kasv pinnal)



Puhasruum

	Standard/meetod	Klass
ISO 14644	Osakeste puhtuse klass	ISO 4
NF S 90-351	Mikrobioloogiline klass	M1/area 4
NF S 90-351	Osakeste kõrvaldamise kineetika	CP(0,5) 5



Avatavus

Plaadid on kergesti avatavad. Minimaalne avamise kõrgus vastavalt paigaldusjoonistele.



Paigaldus

Paigaldus vastavalt paigaldusjoonistele, -juhenditele ja Drawing Aid järgi. Infot minimaalse süsteemi paigalduskõrguse kohta vaata koguste spetsifikatsioonist.



Süsteemi kaal

	kg/m ²	Kaalu teave on indikatiivne ja võib muutuda.
Hygiene Clinic E	1,3	
Hygiene Clinic E + Connect grid system	2,3	



Mehaanilised omadused

Infot Max punktikoormuse ja Min koormuskandevõime kohta vaata tabelist; tehnilisi tingimusi ja mehaanilisi omadusi vaata www.ecophon.ee.



CE

Ecophoni laesüsteemid on CE-märgisega vastavalt Euroopa standardile EN13964:2014. CE-märgisega ehitustooted on hõlmatud toimivusdeklaratsiooniga (Declarations of Performance - DOP), mis võimaldab klientidel ja kasutajatel kergesti võrrelda Euroopa turul olevaid tooteid.



© Saint-Gobain Ecophon AB

KOGUSTE SPETSIFIKATSIOON (VALEMI JÄRGI)

	Mõõdud, mm	
	600x600	1200x600
1 Hygiene Clinic E	2,8/m ²	1,4/m ²
2 Connect T24 kandur, paigaldus 1200 mm tagant	0,9m/m ²	0,9m/m ²
3 Connect T24 vaheliist, L=1200 mm, paigaldus 600 mm tagant	1,7m/m ²	1,7m/m ²
4 Connect T24 vaheliist, L=600 mm	0,9m/m ²	-
5 Connect reguleeritav riputi, paigaldus 1200 mm tagant (max kaugus seinast 600 mm)	0,7/m ²	0,7/m ²
6 Connect riputi klips (mitte kasutada ujula keskkonnas)	0,7/m ²	0,7/m ²
7 Otsekinnituseks: Connect Jäik kinniti, paigaldus 1200 mm tagant	0,7/m ²	0,7/m ²
8 Connect L-servaliist, kinnitus 300 mm tagant	vastavalt vajadusele	
9 Connect topelt-L servaliist, kinnitus 300 mm tagant	vastavalt vajadusele	
10 Connect E-plug (Connect topelt-L servaliistule)	vastavalt vajadusele	
Δ Min. süsteemi paigalduskõrgus, koos reguleeritava riputiga: 110 mm, jäiga kinnitiga: 60 mm	-	-
δ Min. avamise kõrgus: T15: 110 mm, T24: 90 mm	-	-

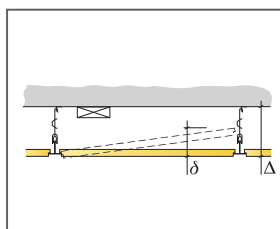

Vaata koguste spetsifikatsiooni

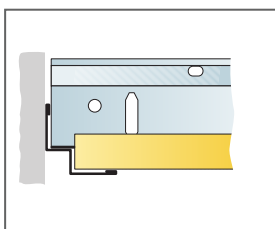

Sirgelt lõigatud plaat toetub topelt-L-servaliistule

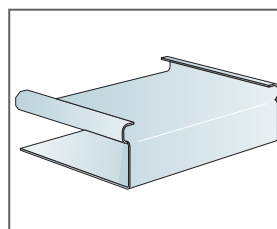

Connect E-plug

Mõõdud, mm	Max punktkoormus [N]	Max punktkoormuse kestvus [N]
600x600x15	50	160
1200x600x15	50	160

Punktkoormus/Punktkoormuse kestvus

Ecophon Hygiene Meditec™

A

Süsteemil Ecophon Hygiene Meditec™ A on nähtav liist, mis sobib kuivadele piirkondadele, kus on vajalik regulaarne desinfitseerimine ja/või puhastamine. Pind takistab hallituse teket ja bakterite vohamist ning talub levinud puhastus- ja desinfitseerimisvahendeid. Helineelduritel on väike emissioonitase, mis tagab kvaliteetse siseõhu.



J. Spain

SÜSTEEMI INFO

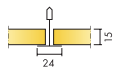

Mõõdud, mm	600x600	1200x600
T24	•	•
Paksus (t)	15	15
Paigaldusjoonis	M255	M255

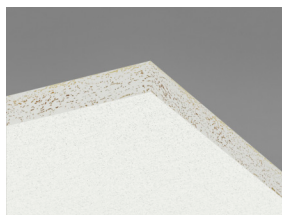

Hygiene Meditec A plaat



Hygiene Meditec A C1 sektsioon koos Connect Universal klipsiga

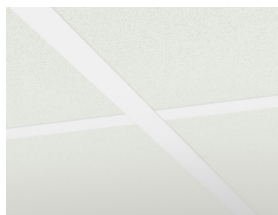

Hygiene Meditec A C1 süsteem

Akustika



Heli neeldumine:

Testitulemused vastavalt: EN ISO 354. Klassifikatsioon vastavalt: EN ISO 11654.

α_p , Praktiline helineelduvustegur

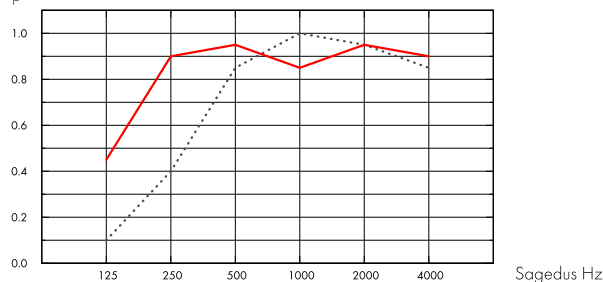

..... Hygiene Meditec A 15 mm, 50 mm o.d.s.

— Hygiene Meditec A 15 mm, 200 mm o.d.s.

o.d.s = üldine süsteemi sügavus

t mm	o.d.s. mm	α_p , Praktiline helineelduvustegur						α_w	Helineeldumisklass
		125 Hz	250 Hz	500 Hz	1000 Hz	2000 Hz	4000 Hz		
15	50	0.10	0.40	0.85	1.00	0.95	0.85	0.70	C
15	200	0.45	0.90	0.95	0.85	0.95	0.90	0.95	A

t mm	o.d.s. mm	NRC	SAA
15	50	0.80	0.83
15	400	0.85	0.89

Siseõhu kvaliteet



Sertifikaat / Märkis

Prantsusmaa LOÜ

Soome M1

A



Cradle to Cradle Certified®



Sellel tootel on pronks taseme Cradle to Cradle Certified® sertifikaat (versioon 4.0).



Material Health

See toode on saanud C2C Certified Material Health Certificate™ hõbedase taseme (standardversioon 4.0). C2C Certified Material Health Certificate™ on toote koostise tervise ja ohutuse kinnitus, kasutades Cradle-to-Cradle Certified Product Standardi Material Health nõudeid.



Süsiniku jalajälg

	kg CO ₂ equiv/m ²	Elutsükli etapid A1 kuni C4 EPD-st, vastavalt standardile ISO 14025 / EN 15804
Hygiene Meditec A	2,71	



Taaskasutus

Minimaalne tarbijajärgne taaskasutatud materjal	44%
Taaskasutus	Täielikult taaskasutatav



Tuleohutus

Riik	Tulestandard	Klass	Toote klaasvillast põhiplaati on testitud ja klassifitseeritud kui mittepõlev vastavalt EN ISO 1182.
Euroopa	EN 13501-1	A2-s1,d0	



Niiskuskindlus

Testitud C-klassi puhul, suhteline õhuniiskus 95% ja 30°C, vastavalt EN 13964:2014



Valguspeegeldus

White 500, lähim NSC värvinäidis S 0500-N, 84% valguspeegeldus.



Puhastatavus

Standard/meetod	Frequency
Tolmu pühkimine	Igapäevane
Märgpuhastus	Igapäevane
Aurupuhastus	1 kord aastas
Vesinikperoksiidi aur	•



Pinna vastupidavus

Toodet on testitud vastavalt standardile ISO 11998, peab vastu 200 tsükli.



Kemikaalitaluvus/desinfektsioon

Kemikaal	Toimeaine	Kontsentratsioon	Testitud vastavalt standardile ISO 11998 ja peab vastu järnevate kemikaalide- või desinfektsiooni vahendite kasutamisele.
Etanol	Ethanol	70%	
Chlorine	Sodium Hypochlorite solution	2,5%	
Virkon S	Sulfamic acid	1%	
Isopropanol	Isopropyl Alcohol	70%	



Hallituse- ja bakteriresistentsus

Standard/meetod	Klass
ISO 846 :2019 meetod C (bakteri jaoks)	0 (Mikroskoobi all ei ole kasvu)
ASTM D3273-16 (seente jaoks)	10 (0% kasv pinnal)



Puhasruum

Standard/meetod	Klass
ISO 14644	Osakeste puhtuse klass ISO 4
NF S 90-351	Mikrobioloogiline klass M1/area 4
NF S 90-351	Osakeste kõrvaldamise kineetika CP(0,5) 5



Avatavus

Plaadid on avatavad. Minimaalne avamise kõrgus vastavalt paigaldusjoonisele. Plaadid on kinnitatud klipsidega, et tagada efektiivne puhastatavus. Klipsid on lihtsalt eemaldatavad lae pealtpoolt. Lihtsalt avatavat Connect hooldusluuki kasutatakse lihtsustamiseks pääsemist lae peale.



Paigaldus

Paigaldus vastavalt paigaldusjoonistele, -juhenditele ja Drawing Aid järgi. Lõigatud plaadiservad tuleb viimistleda Connect servavärviga. Sisselõiked viimistleda sobiva viimistlusvahendiga.



Mehaanilised omadused

Infot Max punktikoormuse ja Min koormuskandevõime kohta vaata tabelist; tehnilisi tingimusi ja mehaanilisi omadusi vaata www.ecophon.ee.



Süsteemi kaal

	kg/m ²
Hygiene Meditec A	1,3
Hygiene Meditec A + Connect grid system	2,3

Kaalu teave on indikatiivne ja võib muutuda.



CE

Ecophoni laesüsteemid on CE-märgisega vastavalt Euroopa standardile EN13964:2014. CE-märgisega ehitustooted on hõlmatud toimusdeklaratsiooniga (Declarations of Performance - DOP), mis võimaldab klientidel ja kasutajatel kergesti võrrelda Euroopa turul olevaid tooteid.

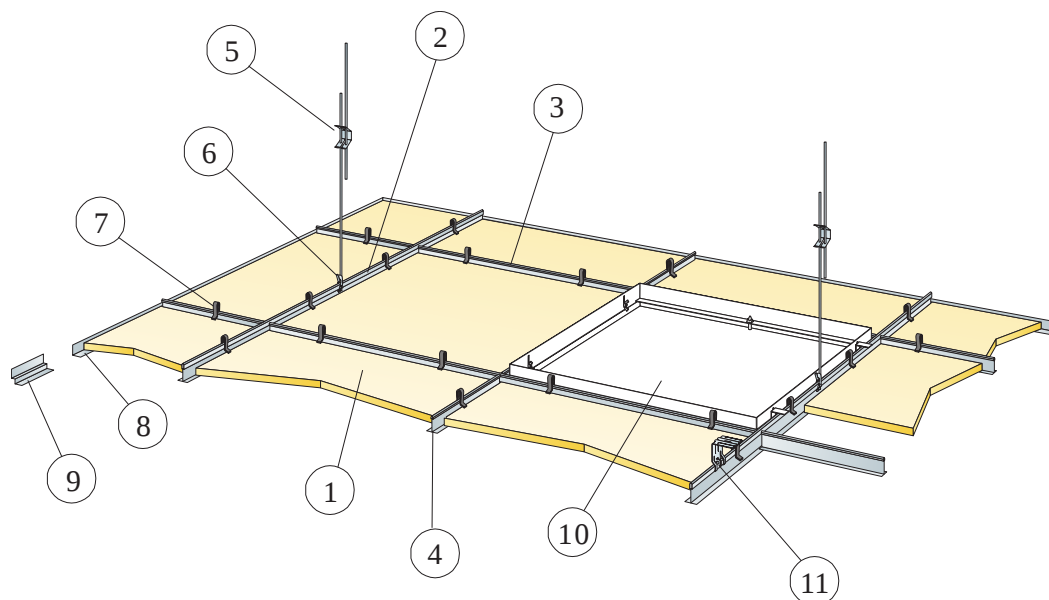

© Saint-Gobain Ecophon AB

KOGUSTE SPETSIFIKATSIOON (VALEMI JÄRGI)

	Mõõdud, mm	
	600x600	1200x600
1 Hygiene Meditec A	2,8/m ²	1,4/m ²
2 Connect T24 kandur, paigaldus 1200 mm tagant	0,9m/m ²	0,9m/m ²
3 Connect T24 vaheliist, L=1200 mm, paigaldus 600 mm tagant	1,7m/m ²	1,7m/m ²
4 Connect T24 vaheliist, L=600 mm	0,9m/m ²	-
5 Connect reguleeritav riputi, paigaldus 1200 mm tagant (max kaugus seinast 600 mm)	0,7/m ²	0,7/m ²
6 Connect riputi klips (mitte kasutada ujula keskkonnas)	0,7/m ²	0,7/m ²
7 Connect Universal klips	11/m ²	7/m ²
8 Alt. Connect L-servaliist, kinnitus c300	vastavalt vajadusele	
9 Alt. Connect topelt-L servaliist, kinnitus c300	vastavalt vajadusele	
10 Connect hooldusluuk	vastavalt vajadusele	
11 Otsekinnituseks: Connect Jäik kinniti, paigaldus 1200 mm tagant	0,7/m ²	0,7/m ²
Δ Min. süsteemi paigalduskõrgus, koos reguleeritava riputi ja klipsiga: 150 mm, otsekinnitusel ilma klipsita: 50 mm.	-	-
δ Min. avamise kõrgus: Klipsiga: 150 mm. Klipsita: 100 mm.	-	-

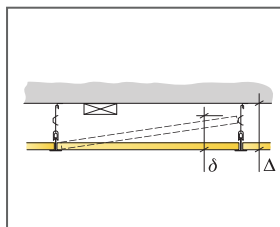

Vaata koguste spetsifikatsiooni

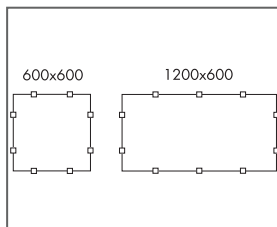

Klipside paigutus

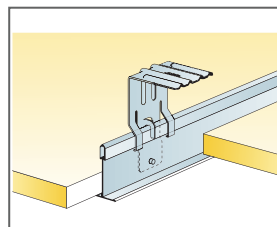

Riputus Connect jäiga kinnitiga

Mõõdud, mm	Max punktkoormus [N]	Max punktkoormuse kestvus [N]
600x600x15	50	160
1200x600x15	50	160

Punktkoormus/Punktkoormuse kestvus

Ecophon Hygiene Meditec™ E

Süsteemil Ecophon Hygiene Meditec™ A on süvistatud nähtav liist ja astmega servakujundus, mis sobib kuivadele piirkondadele, kus on vajalik regulaarne desinfitseerimine ja/või puhastamine. Pind takistab hallituse teket ja bakterite vohamist ning talub levinud puhastus- ja desinfitseerimisvahendeid.



SÜSTEEMI INFO

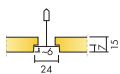

Möödud, mm	600x600	1200x600
T24	•	•
Paksus (t)	15	15
Paigaldusjoonis	M256	M256

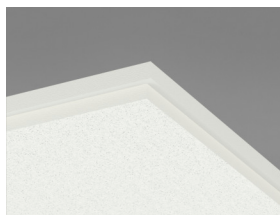

Hygiene Meditec E plaat



Hygiene Meditec E C1 seksioon koos Connect Universal klipsiga



Hygiene Meditec E C1 süsteem

Akustika



Heli neeldumine:

Testitulemused vastavalt: EN ISO 354. Klassifikatsioon vastavalt: EN ISO 11654.

α_p , Praktiline helineelduvustegur

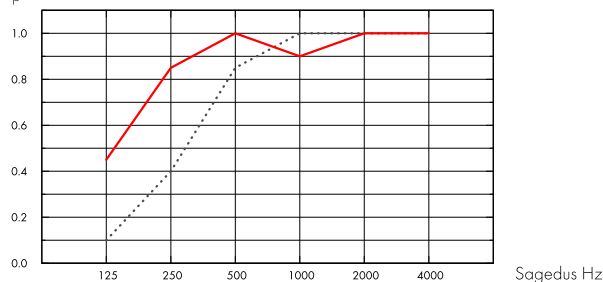

···· Hygiene Meditec E 15 mm, 60 mm o.d.s.

— Hygiene Meditec E 15 mm, 200 mm o.d.s.

o.d.s = üldine süsteemi sügavus

t mm	o.d.s. mm	α_p , Praktiline helineelduvustegur						α_w	Helineeldumisklass
		125 Hz	250 Hz	500 Hz	1000 Hz	2000 Hz	4000 Hz		
15	60	0.10	0.40	0.85	1.00	1.00	1.00	0.70	C
15	200	0.45	0.85	1.00	0.90	1.00	1.00	1.00	A

t mm	o.d.s. mm	NRC	SAA
15	60	0.90	0.87
15	400	0.85	0.89

Siseõhu kvaliteet



Sertifikaat / Märkis

Prantsusmaa LOÜ

Soome M1

A



Cradle to Cradle Certified®



Sellel tootel on pronks taseme Cradle to Cradle Certified® sertifikaat (versioon 4.0).



Material Health

See toode on saanud C2C Certified Material Health Certificate™ hõbedase taseme (standardversioon 4.0). C2C Certified Material Health Certificate™ on toote koostise tervise ja ohutuse kinnitus, kasutades Cradle-to-Cradle Certified Product Standardi Material Health nõudeid.



Süsiniku jalajälg

	kg CO ₂ equiv/m ²	Elutsükli etapid A1 kuni C4 EPD-st, vastavalt standardile ISO 14025 / EN 15804
Hygiene Meditec E	2,37	



Taaskasutus

Minimaalne tarbijajärgne taaskasutatud materjal	43%
Taaskasutus	Täielikult taaskasutatav



Tuleohutus

Riik	Tulestandard	Klass	Toote klaasvillast põhiplaati on testitud ja klassifitseeritud kui mittepõlev vastavalt EN ISO 1182.
Euroopa	EN 13501-1	A2-s1,d0	



Niiskuskindlus

Testitud C-klassi puhul, suhteline õhuniiskus 95% ja 30°C, vastavalt EN 13964:2014



Valguspeegeldus

White 500, lähim NSC värvinäidis S 0500-N, 84% valguspeegeldus.



Puhastatavus

Standard/meetod	Frequency
Tolmu pühkimine	Igapäevane
Märgpuhastus	Igapäevane
Aurupuhastus	1 kord aastas
Vesinikperoksiidi aur	•



Pinna vastupidavus

Toodet on testitud vastavalt standardile ISO 11998, peab vastu 200 tsükli.



Kemikaalitaluvus/desinfektsioon

Kemikaal	Toimeaine	Kontsentratsioon	Testitud vastavalt standardile ISO 11998 ja peab vastu järnevate kemikaalide- või desinfektsiooni vahendite kasutamisele.
Etanol	Ethanol	70%	
Chlorine	Sodium Hypochlorite solution	2,5%	
Virkon S	Sulfamic acid	1%	
Isopropanol	Isopropyl Alcohol	70%	



Hallituse- ja bakteriresistentsus

Standard/meetod	Klass
ISO 846 :2019 meetod C (bakteri jaoks)	0 (Mikroskoobi all ei ole kasvu)
ASTM D3273-16 (seente jaoks)	10 (0% kasv pinnal)



Puhasruum

	Standard/meetod	Klass
ISO 14644	Osakeste puhtuse klass	ISO 4
NF S 90-351	Mikrobioloogiline klass	M1/area 4
NF S 90-351	Osakeste kõrvaldamise kineetika	CP(0,5) 5



Avatavus

Plaadid on avatavad. Minimaalne avamise kõrgus vastavalt paigaldusjoonisele. Plaadid on kinnitatud klipsidega, et tagada efektiivne puhastatavus. Klipsid on lihtsalt eemaldatavad lae pealtpoolt. Lihtsalt avatavat Connect hooldusluuki kasutatakse lihtsustamiseks pääsemist lae peale.



Paigaldus

Paigaldus vastavalt paigaldusjoonistele, -juhenditele ja Drawing Aid järgi. Lõigatud plaadiservad viimistletakse Connect servavärviga. Sisselõiked viimistleda sobiva värviga.



Süsteemi kaal

	kg/m ²	Kaalu teave on indikatiivne ja võib muutuda.
Hygiene Meditec E	1,4	
Hygiene Meditec E + Connect grid system	2,4	



Mehaanilised omadused

Infot Max punktkoormuse ja Min koormuskandevõime kohta vaata tabelist; tehnilisi tingimusi ja mehaanilisi omadusi vaata www.ecophon.ee.



CE

Ecophoni laesüsteemid on CE-märgisega vastavalt Euroopa standardile EN13964:2014. CE-märgisega ehitustooted on hõlmatud toimusdeklaratsiooniga (Declarations of Performance - DOP), mis võimaldab klientidel ja kasutajatel kergesti võrrelda Euroopa turul olevaid tooteid.

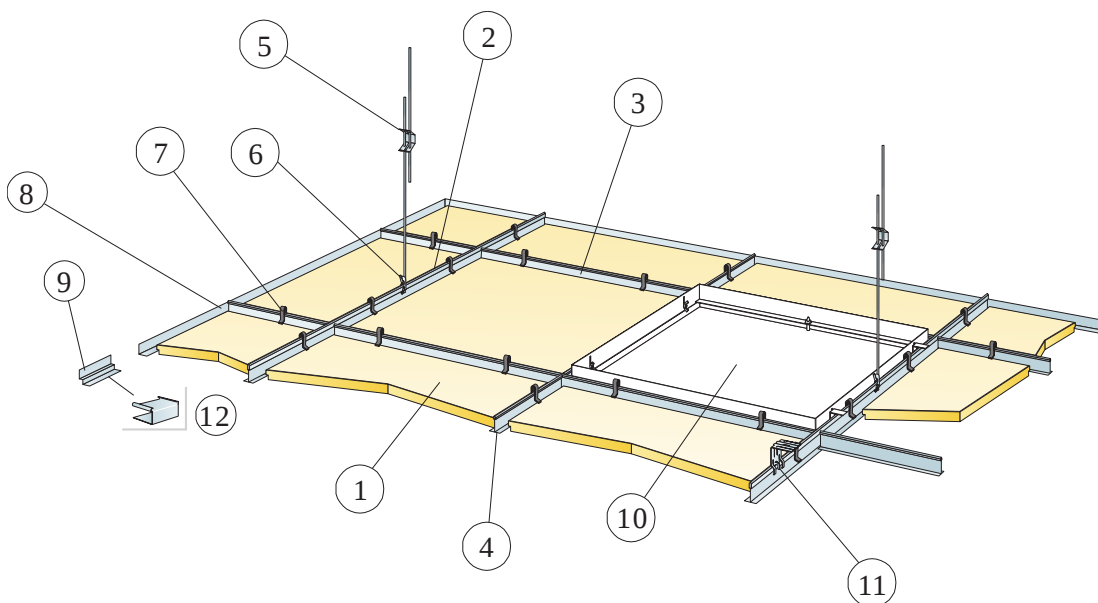

© Saint-Gobain Ecophon AB

KOGUSTE SPETSIFIKATSIOON (VALEMI JÄRGI)

	Mõõdud, mm	
	600x600	1200x600
1 Hygiene Meditec E	2,8/m ²	1,4/m ²
2 Connect T24 kandur, paigaldus 1200 mm tagant	0,9m/m ²	0,9m/m ²
3 Connect T24 vahelist, L=1200 mm, paigaldus 600 mm tagant	1,7m/m ²	1,7m/m ²
4 Connect T24 vahelist, L=600 mm	0,9m/m ²	-
5 Connect reguleeritav riputi, paigaldus 1200 mm tagant (max kaugus seinast 600 mm)	0,7/m ²	0,7/m ²
6 Connect riputi klips (mitte kasutada ujula keskkonnas)	0,7/m ²	0,7/m ²
7 Connect Universal klips	11/m ²	7/m ²
8 Alt. Connect L-servaliist, kinnitus c300	vastavalt vajadusele	
9 Alt. Connect topelt-L servaliist, kinnitus c300	vastavalt vajadusele	
10 Connect hooldusluuk	vastavalt vajadusele	
11 Otsekinnituseks: Connect Jäik kinniti, paigaldus 1200 mm tagant	0,7/m ²	0,7/m ²
12 Connect E-plug (Connect topelt-L servaliistule)	vastavalt vajadusele	
Δ Min. süsteemi paigalduskõrgus, koos reguleeritava riputi ja klipsiga: 160 mm, otsekinnitusel ilma klipsita: 60 mm.	-	-
δ Min. avamise kõrgus: Klipsiga: 160 mm. Klipsita: 110 mm.	-	-

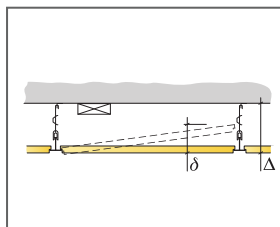

Vaata koguste spetsifikatsiooni

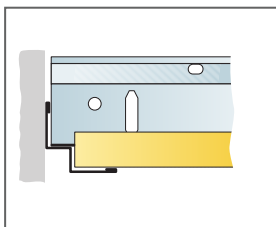

Sirgelt lõigatud, plaat toetub topelt-L-servaliistule

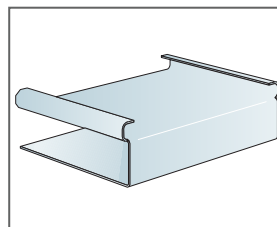

Connect E-plug

Mõõdud, mm	Max punktkoormus [N]	Max punktkoormuse kestvus [N]
600x600x15	50	160
1200x600x15	50	160

Punktkoormus/Punktkoormuse kestvus

Ecophon Hygiene Protec™ A

Süsteemil Ecophon Hygiene Protec™ A on nähtav liist ja mustuseosakesi hülgav pind ning see sobib puhastele ruumidele, kus on vajalik regulaarne desinfitseerimine ja/või puhastamine. Täielikult tihendatud helineelduritel on väike emissioonitase, mis tagab kvaliteetse siseõhu. Need takistavad hallituse teket ja bakterite vohamist.



Unilever Polska, Poland

SÜSTEEMI INFO

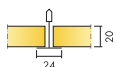

Mõõdud, mm	600x600	625x625	1200x600
T24	•	•	•
Paksus (t)	20	20	20
Paigaldusjoonis	M257	M257 DIN	M257

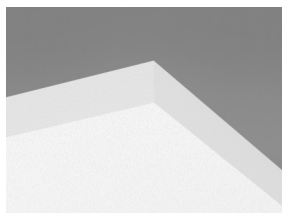

Hygiene Protec A plaat

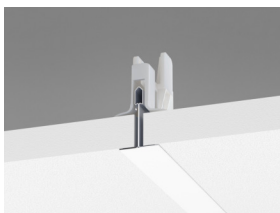

Hygiene Protec A C1 sektsioon koos Connect Hygiene klips 20



Hygiene Protec A süsteem

Akustika



Heli neeldumine:

Testi tulemused vastavalt: EN ISO 354.

Klassifikatsioon vastavalt: EN ISO 11654, ja üksikute väärtuste hinnangud NRC ja SAA kohta (Noise Reduction Coefficient ja Sound Absorption Average), vastavalt: ASTM C 423.

α_p , Praktiline helineelduvustegur

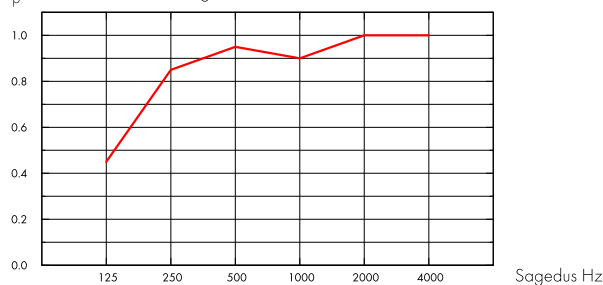

— Hygiene Protec A 20 mm, 200 mm o.d.s.
o.d.s = üldine süsteemi sügavus

t mm	o.d.s. mm	α_p , Praktiline helineelduvustegur						α_w	Helineeldumisklass
		125 Hz	250 Hz	500 Hz	1000 Hz	2000 Hz	4000 Hz		
20	200	0.45	0.85	0.95	0.90	1.00	1.00	0.95	A

t mm	o.d.s. mm	NRC	SAA
20	200	0.95	0.98

Siseõhu kvaliteet



Sertifikaat / Märkis

Prantsusmaa LOÜ

A

Soome M1



Cradle to Cradle Certified®



Sellel tootel on pronks taseme Cradle to Cradle Certified® sertifikaat (versioon 4.0).



Material Health

See toode on saanud C2C Certified Material Health Certificate™ hõbedase taseme (standardversioon 4.0). C2C Certified Material Health Certificate™ on toote koostise tervise ja ohutuse kinnitus, kasutades Cradle-to-Cradle Certified Product Standardi Material Health nõudeid.



Taaskasutus

Minimaalne tarbijajärgne taaskasutatud materjal	44%
Taaskasutus	Täielikult taaskasutatav



Tuleohutus

Riik	Tulestandard	Klass
Euroopa	EN 13501-1	A2-s1,d0

Toote klaasvillast põhiplaati on testitud ja klassifitseeritud kui mittepõlev vastavalt EN ISO 1182.



Niiskuskindlus

Testitud C-klassi puhul, suhteline õhuniiskus 95% ja 30°C, vastavalt EN 13964:2014



Valguspeegeldus

White 500, lähim NSC värvinäidis S 0500-N, 84% valguspeegeldus.



Puhastatavus

Standard/meetod	Frequency
Tolmu pühkimine	Igapäevane
Märgpuhastus	Iganädalane
Aurpuhastus	4 korda aastas
Vesinikperoksiidi aur	•



Pinna vastupidavus

Toodet on testitud vastavalt standardile ISO 11998, peab vastu 200 tsüklit.



Kemikaalitaluvus/desinfektsioon

Kemikaal	Toimeaine	Kontsentratsioon
Etanol	Ethanol	70%
Chlorine	Sodium Hypochlorite solution	2,5%
Virkon S	Sulfamic acid	1%
Isopropanol	Isopropyl Alcohol	70%

Testitud vastavalt standardile ISO 11998 ja peab vastu järnevate kemikaalide- või desinfektsiooni vahendite kasutamisele.



Hallituse- ja bakteriresistentsus

Standard/meetod	Klass
ISO 846 :2019 meetod C (bakteri jaoks)	0 (Mikroskoobi all ei ole kasvu)
ASTM D3273-16 (seente jaoks)	10 (0% kasv pinnal)



Puhasruum

	Standard/meetod	Klass
ISO 14644	Particle cleanliness class	ISO 3
NF S 90-351	Microbiological class	M1/area 4
NF S 90-351	Particle elimination kinetics	CP(0,5) 1



Süsteemi kaal

	kg/m ²	Kaalu teave on indikatiivne ja võib muutuda.
Hygiene Protec A	1,5	
Hygiene Protec A + Connect grid system	2,5	



Paigaldus

Paigaldus vastavalt paigaldusjoonistele, juhenditele ja Drawing Aid järgi. Lõigatud plaadiservad tuleb viimistleda Connect servavärviga. Sisselõiked viimistleda sobiva viimistlusvahendiga.



Avatavus

Plaadid on avatavad. Minimaalne avamise kõrgus vastavalt paigaldusjoonisele. Plaadid on kinnitatud klipsidega, et tagada efektiivne puhastatavus. Klipsid on lihtsalt eemaldatavad lae pealtpoolt. Lihtsalt avatavat Connect hooldusluuki kasutatakse lihtsustamiseks pääsemist lae peale.



Mehaanilised omadused

Infot Max punktkoormuse ja Min koormuskandevõime kohta vaata tabelist; tehnilisi tingimusi ja mehaanilisi omadusi vaata www.ecophon.ee.



CE

Ecophoni laesüsteemid on CE-märgisega vastavalt Euroopa standardile EN13964:2014. CE-märgisega ehitustooted on hõlmatud toimumusdeklaratsiooniga (Declarations of Performance - DOP), mis võimaldab klientidel ja kasutajatel kergesti võrrelda Euroopa turul olevaid tooteid.

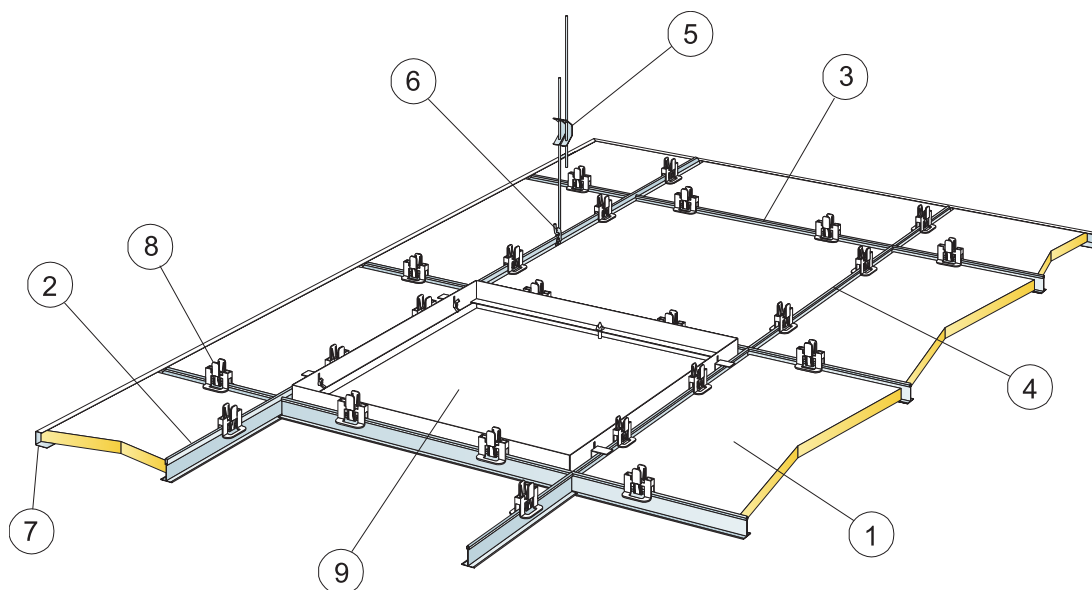

© Saint-Gobain Ecophon AB

KOGUSTE SPETSIFIKATSIOON (VALEMI JÄRGI)

	Mõõdud, mm	
	600x600	1200x600
1 Hygiene Protec A	2,8/m ²	1,4/m ²
2 Connect T24 kandur, paigaldus 1200 mm tagant	0,9m/m ²	0,9m/m ²
3 Connect T24 vaheliist, L=1200 mm, paigaldus 600 mm tagant	1,7m/m ²	1,7m/m ²
4 Connect T24 vaheliist, L=600 mm	0,9m/m ²	-
5 Connect reguleeritav riputi, paigaldus 1200 mm tagant (max kaugus seinast 600 mm)	0,7/m ²	0,7/m ²
6 Connect riputi klips (mitte kasutada ujula keskkonnas)	0,7/m ²	0,7/m ²
7 Connect U-liist, kinnitus c300 mm	vastavalt vajadusele	
8 Connect Hygiene klips 20	11/m ²	7/m ²
9 Connect hooldusluuk	vastavalt vajadusele	
Δ Min. süsteemi paigalduskõrgus: 150 mm	-	-
δ Min. avamise kõrgus: 150 mm	-	-



Vaata koguste spetsifikatsiooni

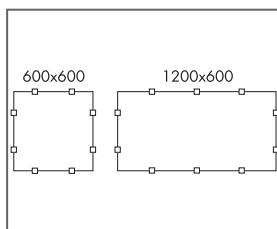

Klipside paigutus

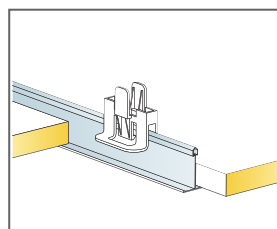

Connect Hygiene klipsid hoiavad plaate paigal

Mõõdud, mm	Max punktkoormus [N]	Max punktkoormuse kestvus [N]
600x600x20	50	160
1200x600x20	50	160

Punktkoormus/Punktkoormuse kestvus

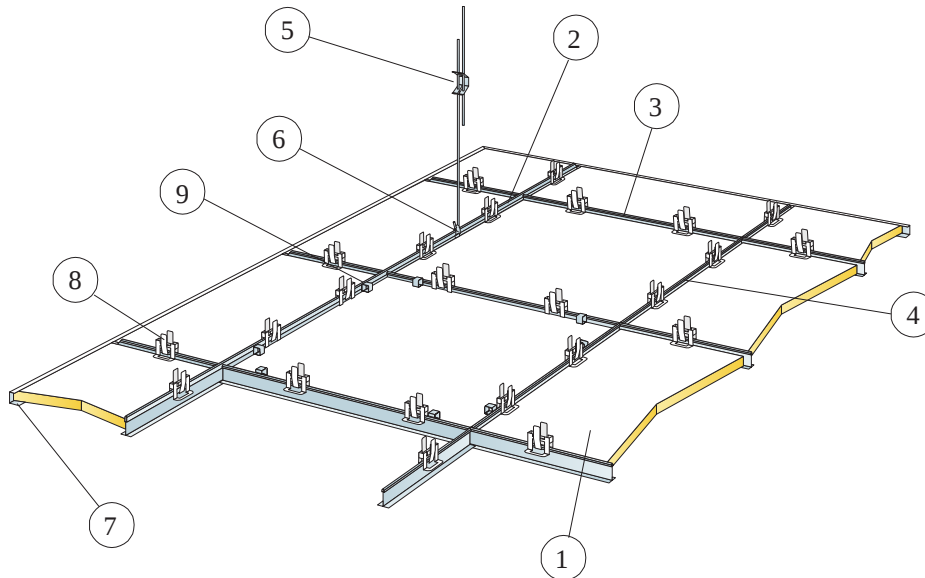

© Saint-Gobain Ecophon AB

KOGUSTE SPETSIFIKATSIOON (VALEMI JÄRGI)

	Mõõdud, mm
	625x625
1	2,6/m ²
2 Connect T24 kandur, paigaldus 1250 mm tagant	0,8m/m ²
3 Connect T24 vaheliist, L=1250 mm, paigaldus 625 mm tagant DIN-ile (vaid valged profiilid)	1,6m/m ²
4 Connect T24 vaheliist, L=625 mm DIN-ile (vaid valged profiilid)	0,8m/m ²
5 Connect reguleeritav riputi, paigaldus 1250 mm tagant (max kaugus seinast 600 mm)	0,7/m ²
6 Connect riputi klips (mitte kasutada ujula keskkonnas)	0,7/m ²
7 Connect U-liist, kinnitus c300 mm	vastavalt vajadusele
8 Connect Hygiene klips 20	10/m ²
9 Connect Demo klips 20 C4, (kuhu ligipääs on vajalik)	vastavalt vajadusele
Δ Min. süsteemi paigalduskõrgus: 150 mm	-
δ Min. avamise kõrgus: 150 mm	-

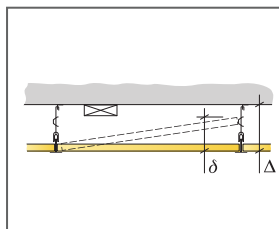

Vaata koguste spetsifikatsiooni

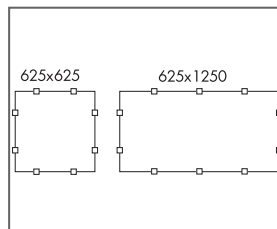

Klipside paigutus

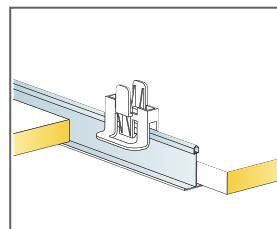

Connect Hygiene klipsid hoiavad plaate paigal

Mõõdud, mm	Max punktikoormus [N]	Max punktikoormuse kestvus [N]
625x625x20	35	160

Punktikoormus/Punktikoormuse kestvus

Ecophon Hygiene Protec™ Ds

Süsteemil Ecophon Hygiene Protec™ Ds on peidetud liist ja mustuseosakesi hülgrav pind ning see sobib puhastele ruumidele, kus on vajalik regulaarne desinfitseerimine ja/või puhastamine. Täielikult tihendatud helineelduritel on väike emissioonitase, mis tagab kvaliteetse siseõhu. Need takistavad hallituse teket ja bakterite vohamist.



Pharma Labor-Vorbereitung, Gießen, Germany

SÜSTEEMI INFO

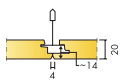

Mõõdud, mm	600x600	1200x600
T24	•	•
Paksus (t)	20	20
Paigaldusjoonis	M615	M615

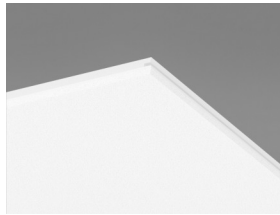

Hygiene Protec Ds plaat

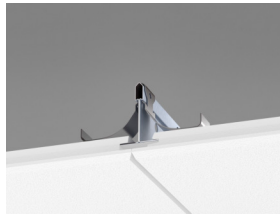

Hygiene Protec Ds C1 sektsioon koos Connect Hold Down klips Ds



Tihendatud seinäühendus

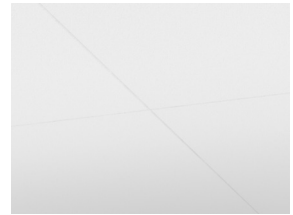

Hygiene Protec Ds C1 süsteem

Akustika



Heli neeldumine:

Testi tulemused vastavalt: EN ISO 354.

Klassifikatsioon vastavalt: EN ISO 11654, ja üksikute väärtuste hinnangud NRC ja SAA kohta (Noise Reduction Coefficient ja Sound Absorption Average), vastavalt: ASTM C 423.

α_p , Praktiline helineelduvustegur

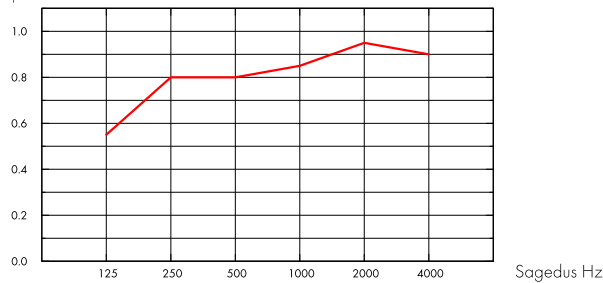

— Hygiene Protec Ds 20 mm, 200 mm o.d.s.
o.d.s = üldine süsteemi sügavus

t mm	o.d.s. mm	α_p , Praktiline helineelduvustegur						α_w	Helineeldumisklass
		125 Hz	250 Hz	500 Hz	1000 Hz	2000 Hz	4000 Hz		
20	200	0.55	0.80	0.80	0.85	0.95	0.90	0.85	B

t mm	o.d.s. mm	NRC	SAA
20	200	0.85	0.85

Siseõhu kvaliteet



Sertifikaat / Märgis

Prantsusmaa LOÜ

A

Soome M1



Cradle to Cradle Certified®



Sellel tootel on pronks taseme Cradle to Cradle Certified® sertifikaat (versioon 4.0).



Material Health

See toode on saanud C2C Certified Material Health Certificate™ hõbedase taseme (standardversioon 4.0). C2C Certified Material Health Certificate™ on toote koostise tervise ja ohutuse kinnitus, kasutades Cradle-to-Cradle Certified Product Standardi Material Health nõudeid.



Süsiniku jalajälg

	kg CO ₂ equiv/m ²	Elutsükli etapid A1 kuni C4 EPD-st, vastavalt standardile ISO 14025 / EN 15804
Hygiene Protec Ds	7,06	



Taaskasutus

Minimaalne tarbijajärgne taaskasutatud materjal	47%
Taaskasutus	Täielikult taaskasutatav



Tuleohutus

Riik	Tulestandard	Klass	Toote klaasvillast põhiplaati on testitud ja klassifitseeritud kui mittepõlev vastavalt EN ISO 1182.
Euroopa	EN 13501-1	A2-s1,d0	



Niiskuskindlus

Testitud C-klassi puhul, suhteline õhuniiskus 95% ja 30°C, vastavalt EN 13964:2014



Valguspeegeldus

White 500, lähim NSC värvinäidis S 0500-N, 84% valguspeegeldus.



Puhastatavus

Standard/meetod	Frequency
Tolmu pühkimine	Igapäevane
Märgpuhastus	Iganädalane
Aurupuhastus	4 korda aastas
Vesinikperoksiidi aur	•



Pinna vastupidavus

Toodet on testitud vastavalt standardile ISO 11998, peab vastu 200 tsükli.



Kemikaalitaluvus/desinfektsioon

Kemikaal	Toimeaine	Kontsentratsioon	Testitud vastavalt standardile ISO 11998 ja peab vastu järnevate kemikaalide- või desinfektsiooni vahendite kasutamisele.
Etanol	Ethanol	70%	
Chlorine	Sodium Hypochlorite solution	2,5%	
Virkon S	Sulfamic acid	1%	
Isopropanol	Isopropyl Alcohol	70%	



Hallituse- ja bakteriresistentsus

Standard/meetod	Klass
ISO 846 :2019 meetod C (bakteri jaoks)	0 (Mikroskoobi all ei ole kasvu)
ASTM D3273-16 (seente jaoks)	10 (0% kasv pinnal)



Puhasruum

	Standard/meetod	Klass
ISO 14644	Particle cleanliness class	ISO 3
NF S 90-351	Microbiological class	M1/area 4
NF S 90-351	Particle elimination kinetics	CP(0,5) 1



Avatavus

Plaadid on avatavad.



Paigaldus

Paigaldus vastavalt paigaldusjoonistele, -juhenditele ja Drawing Aid järgi. Lõigatud plaadiservad viimistletakse Connect servavärviga. Sisselõiked viimistleda sobiva värviga.



Süsteemi kaal

	kg/m ²
Hygiene Protec Ds	2,9
Hygiene Protec Ds + Connect grid system	3,8

Kaalu teave on indikatiivne ja võib muutuda.



Mehaanilised omadused

Infot Max punktkoormuse ja Min koormuskandevõime kohta vaata tabelist; tehnilisi tingimusi ja mehaanilisi omadusi vaata www.ecophon.ee.



CE

Ecophoni laesüsteemid on CE-märgisega vastavalt Euroopa standardile EN13964:2014. CE-märgisega ehitustooted on hõlmatud toimivusdeklaratsiooniga (Declarations of Performance - DOP), mis võimaldab klientidel ja kasutajatel kergesti võrrelda Euroopa turul olevaid tooteid.

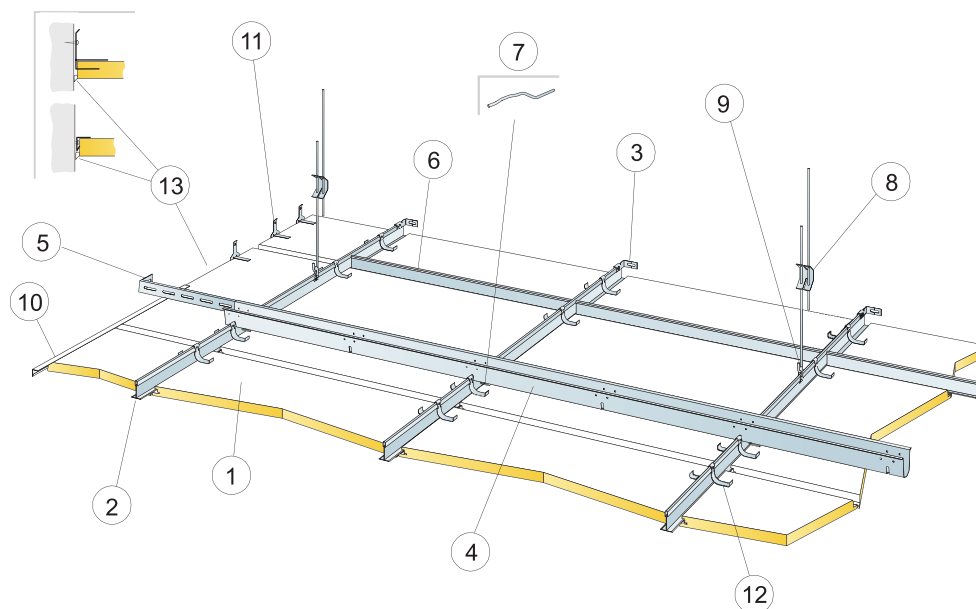

© Saint-Gobain Ecophon AB

KOGUSTE SPETSIFIKATSIOON (VALEMI JÄRGI)

	Mõõdud, mm	
	600x600	1200x600
1 Hygiene Protec Ds	2,8/m ²	1,4/m ²
2 Connect T24 kandur PL, paigaldus 600 mm tagant	1,7m/m ²	1,7m/m ²
3 Connect T-profilide seinakinniti	1/paigaldatud kanduri rivi kohta	
4 Connect distantsprofiil, paigaldus 1500 mm tagant (max. kaugus seinast 300 mm)	0,7m/m ²	0,7m/m ²
5 Connect seinakinniti, L=700 mm, Connect distantsprofiilile	1/iga distantsliistu kohta	
6 Connect T24 vaheliist, L=600 mm	2/kanduri rivi kohta	
7 Connect distantsprofiili splint, üks iga Connect kanduri/Connect distantsprofiili liite kohta	1,4/m ²	1,4/m ²
8 Connect reguleeritav riputi, paigaldus 1200 mm tagant (max kaugus seinast 600 mm)	0,7/m ²	0,7/m ²
9 Connect riputi klips (mitte kasutada ujula keskkonnas)	0,7/m ²	0,7/m ²
10 Alt. Connect Frieze Trim, kinnitus c300 mm	vastavalt vajadusele	
11 Connect Frieze Bracket, paigaldus 500 mm tagant. Minimaalne vaba ruum ülevalpool plaati 150 mm.	2/lõigatud paneel, 3/lõigatud paneel, ühe kandva servaga ühe kandva servaga	
12 Connect Hold Down klips Ds	2/plaat, nurkadest 50-100 mm	3/plaat, nurkadest 50-100 mm
13 Hermeetik (ei kuulu Ecophoni tootevalikusse)	vastavalt vajadusele	
Δ Min. süsteemi paigalduskõrgus: 170 mm	-	-
δ Min. avamise kõrgus: 30 mm	-	-

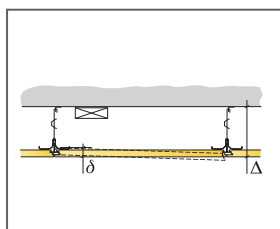

Vaata koguse spetsifikatsiooni

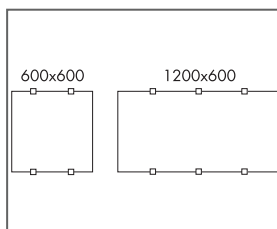

Klipside paigutus

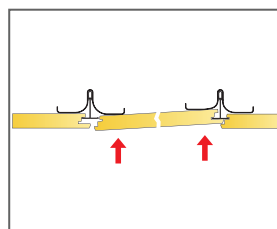

Plaadi avamine altpoolt

Mõõdud, mm	Max punktkoormus [N]	Max punktkoormuse kestvus [N]
600x600x20	30	160
1200x600x20	30	160

Punktkoormus/Punktkoormuse kestvus

Ecophon Hygiene Protec™ Air

A

Süsteemil Ecophon Hygiene Protec™ Air A on nähtav liist ja mustuseosakesi hõlgav pind ning see sobib puhastele ruumidele, kus on vajalik regulaarne desinfitseerimine ja/või puhastamine. Sobivad piirkondadesse, kus on vaja õhusurvet reguleerida. Need takistavad hallituse teket ja bakterite vohamist ning taluvad HPV-puhastust.



Beiersdorf, Hamburg, Germany

SÜSTEEMI INFO

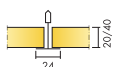

Möödud, mm	600x600	600x600	1200x600	1200x600
T24	•	•	•	•
Paksus (t)	20	40	20	40
Paigaldusjoonis	M469	M469	M469	M469

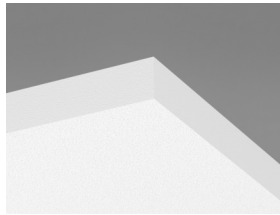

Hygiene Protec Air A plaat

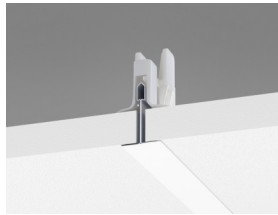

Hygiene Protec Air A C1 seksioon koos Connect Hygiene klips 20



Hygiene Protec Air A C1 süsteem

Akustika



Heli neeldumine:

Testitulemused vastavalt: EN ISO 354. Klassifikatsioon vastavalt: EN ISO 11654.

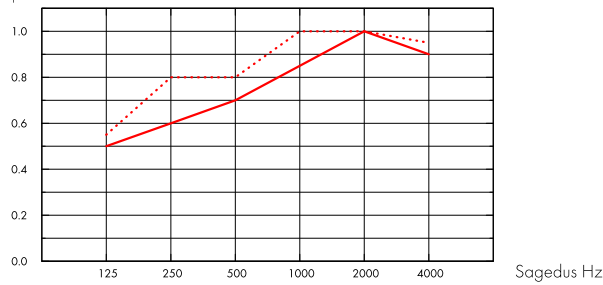
 α_p , Praktiline helineelduvustegur

— Hygiene Protec Air A 20 mm, 200 mm o.d.s.

- - - Hygiene Protec Air A 40 mm, 200 mm o.d.s.

o.d.s = üldine süsteemi sügavus

t mm	o.d.s. mm	α_p , Praktiline helineelduvustegur						α_w	Helineeldumisklass
		125 Hz	250 Hz	500 Hz	1000 Hz	2000 Hz	4000 Hz		
20	200	0.50	0.60	0.70	0.85	1.00	0.90	0.80	B
40	200	0.55	0.80	0.80	1.00	1.00	0.95	0.90	A

t mm	o.d.s. mm	NRC	SAA
20	200	0.80	0.81
40	200	0.90	0.92

Siseõhu kvaliteet



Sertifikaat / Märkis

Eurofins Indoor Air Comfort®

IAC Gold

Prantsusmaa LOÜ

A+



Süsiniku jalajälg

kg CO₂ equiv/m²

Hygiene Protec Air A

4,45

Elutsükli etapid A1 kuni C4 EPD-st, vastavalt standardile ISO 14025 / EN 15804

Taaskasutus



Minimaalne tarbijajärgne taaskasutatud materjal

38%

Taaskasutus

Täielikult taaskasutatav



Tuleohutus

Riik	Tulestandard	Klass
Euroopa	EN 13501-1	A2-s1,d0

Toote klaasvillast põhiplaati on testitud ja klassifitseeritud kui mittepõlev vastavalt EN ISO 1182.



Niiskuskindlus

Testitud C-klassi puhul, suhteline õhuniiskus 95% ja 30°C, vastavalt EN 13964:2014



Valguspeegeldus

White 500, lähim NSC värvinäidis S 0500-N, 84% valguspeegeldus.



Puhastatavus

Standard/meetod	Frequency
Tolmu pühkimine	Igapäevane
Märgpuhastus	Iganädalane
Aurupuhastus	4 korda aastas
Vesinikperoksiidi aur	•



Pinna vastupidavus

Toodet on testitud vastavalt standardile ISO 11998, peab vastu 200 tsükli.



Kemikaalitaluvus/desinfektsioon

Kemikaal	Toimeaine	Kontsentratsioon
Etanol	Ethanol	70%
Chlorine	Sodium Hypochlorite solution	2,5%
Virkon S	Sulfamic acid	1%
Isopropanol	Isopropyl Alcohol	70%

Testitud vastavalt standardile ISO 11998 ja peab vastu järnevate kemikaalide- või desinfektsiooni vahendite kasutamisele.



Hallituse- ja bakteriresistentsus

Standard/meetod	Klass
ISO 846 :2019 meetod C (bakteri jaoks)	0 (Mikroskoobi all ei ole kasvu)
ASTM D3273-16 (seente jaoks)	10 (0% kasv pinnal)



Puhasruum

Standard/meetod	Klass
ISO 14644	Particle cleanliness class ISO 3
NF S 90-351	Microbiological class M1/area 4
NF S 90-351	Particle elimination kinetics CP(0,5) 1



Õhu läbilaskvus

Protec Air A 20 mm	Positiivne rõhk m ³ /(h x m ²)	Negatiivne rõhk m ³ /(h x m ²)	Positiivne rõhk L/s/m ²	Negatiivne rõhk L/s/m ²	Protec Air A 40 mm	Positiivne rõhk m ³ /(h x m ²)	Negatiivne rõhk m ³ /(h x m ²)	Positiivne rõhk L/s/m ²	Negatiivne rõhk L/s/m ²	Õhulekke kiirus mõõdetuna positiivsel vastaval negatiivsel ruumirõhul kuni 50 Pa (Q50) EN ISO 9972 :2015
10 (Pa)	16,1	15,0	4,0	4,2	10 (Pa)	14,6	16,9	4,0	4,7	
20 (Pa)	27,9	22,1	7,8	6,1	20 (Pa)	25,7	26,5	7,1	7,4	
30 (Pa)	38,5	27,7	10,7	7,7	30 (Pa)	35,8	34,4	9,9	9,6	
40 (Pa)	48,4	32,5	13,4	9,0	40 (Pa)	45,2	41,4	12,6	11,5	
50 (Pa) /Q50	57,8	36,8	16,1	10,2	50 (Pa) /Q50	54,3	47,8	15,1	13,3	



Avatavus

Plaadid on avatavad. Minimaalne avamise kõrgus vastavalt paigaldusjoonisele. Plaadid on kinnitatud klipsidega, et tagada efektiivne puhastatavus. Klipsid on lihtsalt eemaldatavad lae pealtpoolt. Lihtsalt avatavat Connect hooldusluuki kasutatakse lihtsustamiseks pääsemist lae peale.



Paigaldus

Paigaldus vastavalt paigaldusjoonistele, -juhenditele ja Drawing Aid järgi. Lõigatud plaadiservad viimistletakse Connect servavärviga. Sisselõiked viimistleda sobiva värviga.



Süsteemi kaal

	kg/m ²	Kaalu teave on indikatiivne ja võib muutuda.
Hygiene Protec Air A 20 mm	2,0	
Hygiene Protec Air A 20 mm + Connect grid system	3,0	
Hygiene Protec Air A 40 mm	3,0	
Hygiene Protec Air A 40 mm + Connect grid system	4,0	



Mehaanilised omadused

Infot Max punktkoormuse ja Min koormuskandevõime kohta vaata tabelist; tehnilisi tingimusi ja mehaanilisi omadusi vaata www.ecophon.ee.



CE

Ecophoni laesüsteemid on CE-märgisega vastavalt Euroopa standardile EN13964:2014. CE-märgisega ehitustooted on hõlmatud toimusdeklaratsiooniga (Declarations of Performance - DOP), mis võimaldab klientidel ja kasutajatel kergesti võrrelda Euroopa turul olevaid tooteid.

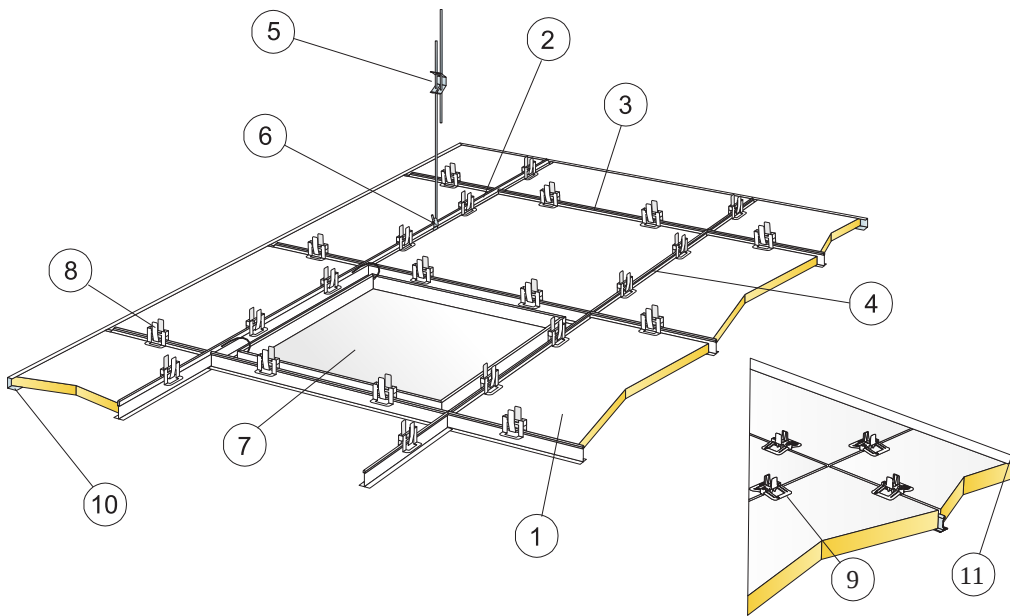

© Saint-Gobain Ecophon AB

KOGUSTE SPETSIFIKATSIOON (VALEMI JÄRGI)

	Mõõdud, mm	
	600x600	1200x600
1 Hygiene Protec Air A	2,8/m ²	1,4/m ²
2 Connect T24 kandur, paigaldus 1200 mm tagant	0,9m/m ²	0,9m/m ²
3 Connect T24 vahelist, L=1200 mm, paigaldus 600 mm tagant	1,7m/m ²	1,7m/m ²
4 Connect T24 vahelist, L=600 mm	0,9m/m ²	-
5 Connect reguleeritav riputi, paigaldus 1200 mm tagant (max kaugus seinast 600 mm)	0,7/m ²	0,7/m ²
6 Connect riputi klips (mitte kasutada ujula keskkonnas)	0,7/m ²	0,7/m ²
7 Connect hooldusluuk C3	vastavalt vajadusele	
8 Connect Hygiene klips 20	11/m ²	7/m ²
9 Connect Hygiene klips 40	11/m ²	7/m ²
10 Connect U-liist, kinnitus c300 (20 mm plaadile)	vastavalt vajadusele	
11 Connect U-liist, kinnitus c300 (40 mm plaadile)	vastavalt vajadusele	
Connect Edge Sealant	vastavalt vajadusele	
Δ Min. süsteemi paigalduskõrgus: 150 mm	-	-
δ Min. avamise kõrgus 20 mm: 150 mm	-	-
δ Min. avamise kõrgus 40 mm: 170 mm	-	-

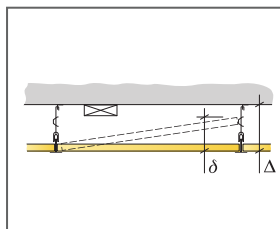

Vaata koguste spetsifikatsiooni

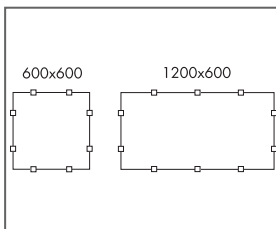

Klipside paigutus

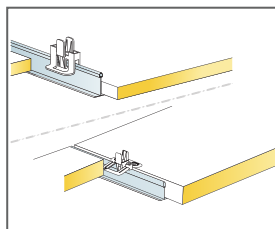

Klipsi plaadile paigaldamiseks. 20/40 mm plaadile.

Mõõdud, mm	Max punktkoormus [N]	Max punktkoormuse kestvus [N]
600x600x20	50	160
600x600x40	50	160
1200x600x20	50	160
1200x600x40	50	160

Punktkoormus/Punktkoormuse kestvus

Ecophon Hygiene Performance™ A

Ecophon Hygiene Performance™ A sobib niisketesse piirkondadesse ja talub põhjalikku puhastamist, nagu regulaarne pesemine auru ja kõrg-/madalsurvepesuga. Pind talub levinud puhastus- ja desinfitseerimisvahendeid.



SÜSTEEMI INFO

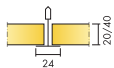

Mõõdud, mm	600x600	600x600	1200x600	1200x600
T24	•	•	•	•
Paksus (t)	20	40	20	40
Paigaldusjoonis	M395C3, M266C4	M395C3, M266C4	M395C3, M266C4	M395C3, M266C4

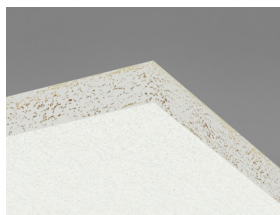

Hygiene Performance A plaat



Hygiene Performance A C3 sektsioon koos Connect Hygiene klips 20

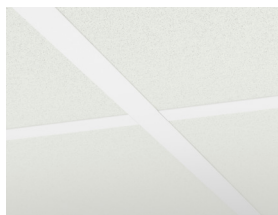

Hygiene Performance A süsteem

Akustika



Heli neeldumine:

Testitulemused vastavalt: EN ISO 354. Klassifikatsioon vastavalt: EN ISO 11654.

α_p , Praktiline helineelduvustegur

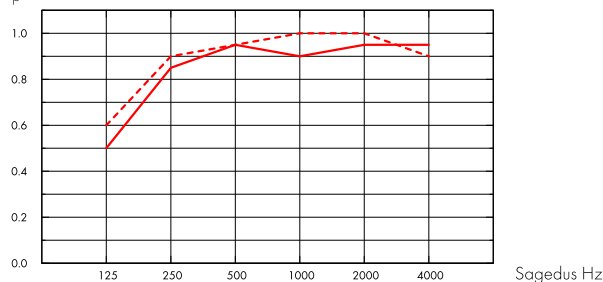

— Hygiene Performance A 20 mm, 200 mm o.d.s.

- - - Hygiene Performance A 40 mm, 200 mm o.d.s.

o.d.s = üldine süsteemi sügavus

t mm	o.d.s. mm	α_p , Praktiline helineelduvustegur						α_w	Helineeldumisklass
		125 Hz	250 Hz	500 Hz	1000 Hz	2000 Hz	4000 Hz		
20	200	0.50	0.85	0.95	0.90	0.95	0.95	0.95	A
40	200	0.60	0.90	0.95	1.00	1.00	0.90	1.00	A

t mm	o.d.s. mm	NRC	SAA
20	200	0.90	0.92
40	200	0.95	0.96

Siseõhu kvaliteet



Sertifikaat / Märgis

Prantsusmaa LOÜ

Soome M1

A



Cradle to Cradle Certified®



Sellel tootel on pronks taseme Cradle to Cradle Certified® sertifikaat (versioon 4.0).



Material Health

See toode on saanud C2C Certified Material Health Certificate™ hõbedase taseme (standardversioon 4.0). C2C Certified Material Health Certificate™ on toote koostise tervise ja ohutuse kinnitus, kasutades Cradle-to-Cradle Certified Product Standardi Material Health nõudeid.



Süsiniku jalajälg

	kg CO ₂ equiv/m ²
Hygiene Performance A 20 mm	2,43
Hygiene Performance A 40 mm	4,22

Elutsükli etapid A1 kuni C4 EPD-st, vastavalt standardile ISO 14025 / EN 15804



Taaskasutus

Minimaalne tarbijajõrgne taaskasutatud materjal	47%
Taaskasutus	Täielikult taaskasutatav



Tuleohutus

Riik	Tulestandard	Klass
Euroopa	EN 13501-1	A2-s1,d0

Toote klaasvillast põhiplaati on testitud ja klassifitseeritud kui mittepõlev vastavalt EN ISO 1182.



Niiskuskindlus

Klass D, suhteline õhuniiskus 97% ja 50 °C, vastavalt standardile EN 13964:2014



Valguspeegeldus

White 500, lähim NSC värvinäidis S 0500-N, 84% valguspeegeldus.



Puhastatavus

Standard/meetod	Frequency
Tolmu pühkimine	Igapäevane
Märgpuhastus	Iganädalane
Aurupuhastus	4 korda aastas
Madalsurvepuhastus	2 korda aastas
Kõrgsurvepuhastus	2 korda aastas
Vesinikperoksiidi aur	•



Pinna vastupidavus

Toodet on testitud vastavalt standardile ISO 11998, peab vastu 200 tsükli.



Kemikaalitaluvus/desinfektsioon

Kemikaal	Toimeaine	Kontsentratsioon
Actichlor plus	NaDCC (Sodium Dichloroisocyanurate)	1%
LifeClean	Chlorine dioxide	Undiluted
Etanol	Ethanol	70%
Chlorine	Sodium Hypochlorite solution	2,5%
Virkon S	Sulfamic acid	1%
Isopropanol	Isopropyl Alcohol	70%
Acipusfoam VF59	Nitric Acid	5%

Testitud vastavalt standardile ISO 11998 ja peab vastu järnevate kemikaalide- või desinfektsiooni vahendite kasutamisele.



Hallituse- ja bakteriresistentsus

Standard/meetod	Klass
ISO 846 :2019 meetod C (bakteri jaoks)	0 (Mikroskoobi all ei ole kasvu)
ASTM D3273-16 (seente jaoks)	10 (0% kasv pinnal)



Puhasruum

Standard/meetod	Klass
ISO 14644	Osakeste puhtuse klass ISO 4
NF S 90-351	Mikrobioloogiline klass M1/area 4
NF S 90-351	Osakeste kõrvaldamise kineetika CP(0,5) 5



Avatavus

Plaadid on avatavad. Minimaalne avamise kõrgus vastavalt paigaldusjoonisele. Plaadid on kinnitatud klipsidega, et tagada efektiivne puhastatavus. Klipsid on lihtsalt eemaldatavad lae pealtpoolt. Lihtsalt avatavat Connect hooldusluuki kasutatakse lihtsustamiseks pääsemist lae peale.



Paigaldus

Paigaldus vastavalt paigaldusjoonistele, -juhenditele ja Drawing Aid järgi. Lõigatud plaadiservad tuleb viimistleda Connect servavärviga. Sisselõiked viimistleda sobiva viimistlusvahendiga.



Süsteemi kaal

	kg/m ²
Hygiene Performance A 20 mm	1,6
Hygiene Performance A 20 mm + Connect grid system	2,6
Hygiene Performance A 40 mm	2,6
Hygiene Performance A 40 mm + Connect grid system	3,6

Kaalu teave on indikatiivne ja võib muutuda.



Mehaanilised omadused

Infot Max punktkoormuse ja Min koormuskandevõime kohta vaata tabelist; tehnilisi tingimusi ja mehaanilisi omadusi vaata www.ecophon.ee.



CE

Ecophoni laesüsteemid on CE-märgisega vastavalt Euroopa standardile EN13964:2014. CE-märgisega ehitustooted on hõlmatud toimivusdeklaratsiooniga (Declarations of Performance - DOP), mis võimaldab klientidel ja kasutajatel kergesti võrrelda Euroopa turul olevaid tooteid.

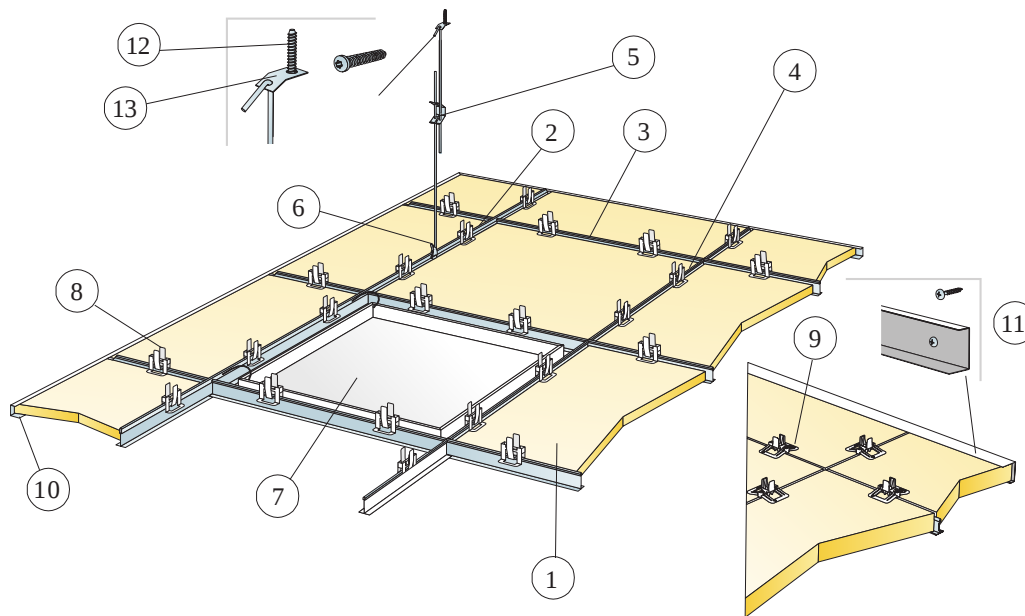

© Saint-Gobain Ecophon AB

KOGUSTE SPETSIFIKATSIOON (VALEMI JÄRGI)

		Mõõdud, mm	
		600x600	1200x600
1	Hygiene Performance A	2,8/m ²	1,4/m ²
2	Connect T24 kandur C3, paigaldus 1200 mm tagant	0,9m/m ²	0,9m/m ²
3	Connect T24 vahelist C3, L=600 mm	0,9m/m ²	-
4	Connect T24 vahelist C3, L=1200 mm, paigaldus 600 mm tagant	1,7m/m ²	1,7m/m ²
5	Connect reguleeritav riputi C3, c1200 (max kaugus seinast 600 mm)	0,7/m ²	0,7/m ²
6	Connect riputi klips (mitte kasutada ujula keskkonnas)	0,7/m ²	0,7/m ²
7	Connect hooldusluuk C3	vastavalt vajadusele	
8	Connect Hygiene klips 20	11/m ²	7/m ²
9	Connect Hygiene klips 40	11/m ²	7/m ²
10	Connect U-liist C3, kinnitus c300 (20 mm plaadile)	vastavalt vajadusele	
11	Connect U-liist C3, kinnitus c300 (40 mm plaadile)	vastavalt vajadusele	
12	Connect Anchor kruvi C4	0,7/m ²	0,7/m ²
13	Connect kinnitusplaat C4	0,7/m ²	0,7/m ²
Δ Min. süsteemi paigalduskõrgus: 150 mm		-	-
δ Min. avamise kõrgus 20 mm: 150 mm		-	-
δ Min. avamise kõrgus 40 mm: 170 mm		-	-

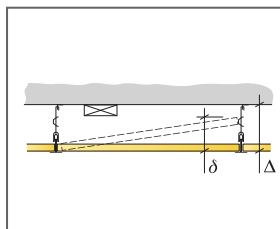

Vaata koguste spetsifikatsiooni

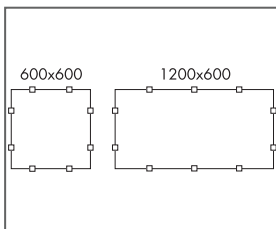

Klipside paigutus

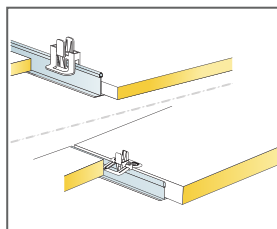

Klipsi plaatide paigaldamiseks. 20/40 mm plaatidele.

Mõõdud, mm	Max punktkoormus [N]	Max punktkoormuse kestvus [N]
600x600x20	50	160
600x600x40	50	160
1200x600x20	50	160
1200x600x40	50	160

Punktkoormus/Punktkoormuse kestvus plaatidele.

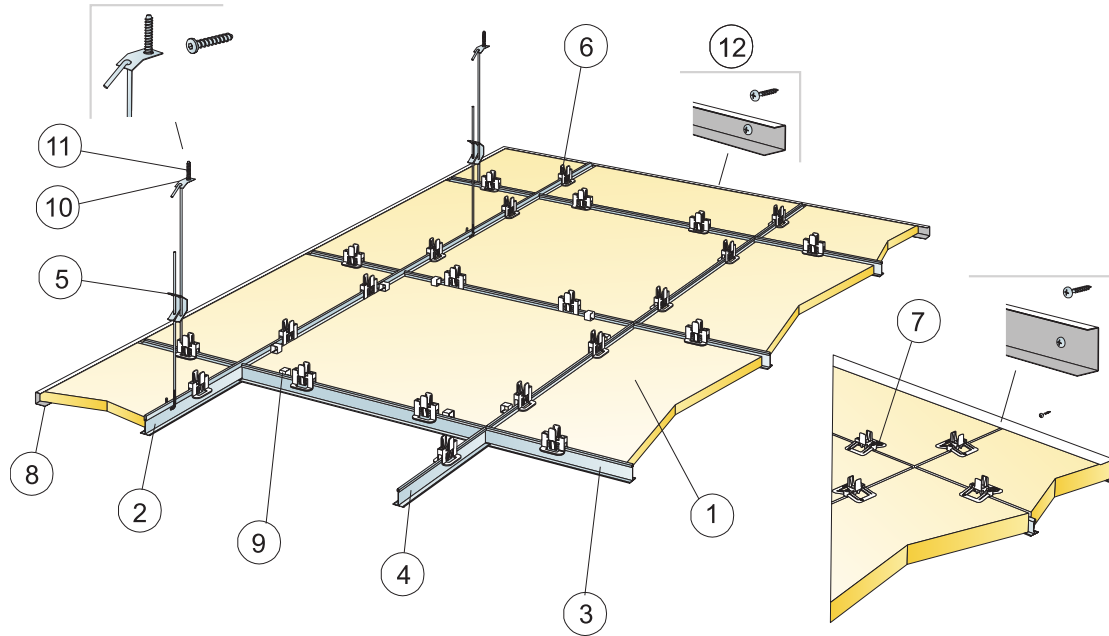

© Saint-Gobain Ecophon AB

KOGUSTE SPETSIFIKATSIOON (VALEMI JÄRGI)

		Mõõdud, mm	
		600x600	1200x600
1	Hygiene Performance A	2,8/m ²	1,4/m ²
2	Connect T24 kandur C4, c1200	0,9m/m ²	0,9m/m ²
3	Connect T24 vaheliist C4, L=1200, c600	1,7m/m ²	1,7m/m ²
4	Connect T24 vaheliist C4, L=600	0,9m/m ²	-
5	Connect reguleeritav riputi C4, c1200, (max kaugus seinast 600 mm)	0,7/m ²	0,7/m ²
6	Connect Hygiene klips 20	11/m ²	7/m ²
7	Connect Hygiene klips 40 C4	11/m ²	7/m ²
8	Connect U-liist C4, kinnitus c300	vastavalt vajadusele	
9	Connect Demo klips 20 C4, (kuhu ligipääs on vajalik)	vastavalt vajadusele	
10	Connect kinnitusplaat C4	0,7/m ²	0,7/m ²
11	Connect Anchor kruvi C4	0,7/m ²	0,7/m ²
12	Connect Paigalduskruvi C4	3,4/m U-liist C4	
Δ Min. süsteemi paigalduskõrgus: 150 mm		-	-
δ Min. avamise kõrgus: 150 mm		-	-
δ Min. avamise kõrgus 40 mm: 170 mm		-	-

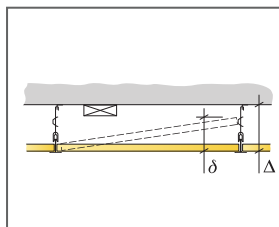

Vaata koguste spetsifikatsiooni

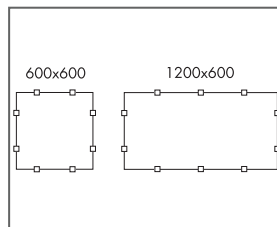

Klipside paigutus

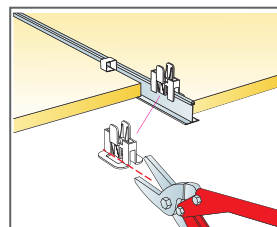

Connect Hygiene klips 20 lõikamine hooldusplaadi jaoks

Mõõdud, mm	Max punktkoormus [N]	Max punktkoormuse kestvus [N]
600x600x20	50	160
600x600x40	50	160
1200x600x20	50	160
1200x600x40	50	160

Punktkoormus/Punktkoormuse kestvus



Ecophon Hygiene Performance™ B

Ecophon Hygiene Performance™ B on liimitav servani paigaldatav laeplaat, mis loob sileda välimusega lae. Kaldserv tekitab iga plaadi vahele kitsa soone. Rakenduste jaoks, kus nõutakse süsteemi minimaalset võimalikku sügavust. Toode talub korrapäraselt abrasiivset märgpühkimist ja täiustatud puhastust, näiteks aurupuhastust.



SÜSTEEMI INFO

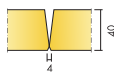

Mõõdud, mm	600x600	1200x600
Otsekinnitus	•	•
Paksus (t)	40	40
Paigaldusjoonis	M638	M638

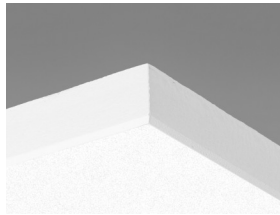

Hygiene Performance B plaat

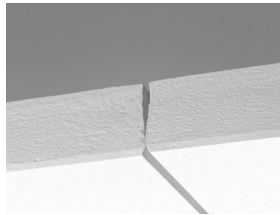

Hygiene Performance B süsteemi sektsioon

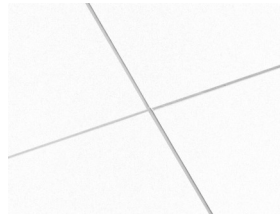

Hygiene Performance B süsteem

Akustika



Heli neeldumine:

Testi tulemused vastavalt: EN ISO 354.

Klassifikatsioon vastavalt: EN ISO 11654, ja üksikute väärtuste hinnangud NRC ja SAA kohta (Noise Reduction Coefficient ja Sound Absorption Average), vastavalt: ASTM C 423.

α_p , Praktiline helineelduvustegur

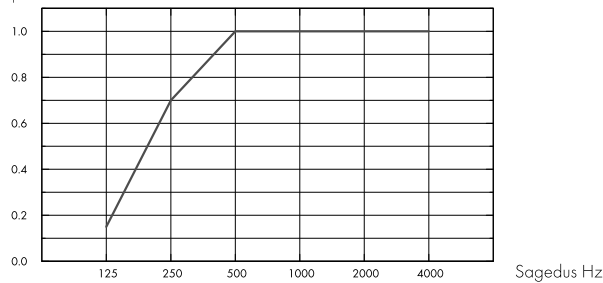

– Performance B, 43mm o.d.s.
o.d.s = üldine süsteemi sügavus

t mm	o.d.s. mm	α_p , Praktiline helineelduvustegur						α_w	Helineeldumisklass
		125 Hz	250 Hz	500 Hz	1000 Hz	2000 Hz	4000 Hz		
40	43	0.15	0.70	1.00	1.00	1.00	1.00	1.00	A

t mm	o.d.s. mm	NRC	SAA
40	43	0.95	0.95

Siseõhu kvaliteet



Sertifikaat / Märkis

Prantsusmaa LOÜ

A

Soome M1

•



Taaskasutus



Minimaalne tarbijajärgne taaskasutatud materjal

57%

Taaskasutus

Täielikult taaskasutatav

Tuleohutus



Riik
Euroopa

Tulestandard
EN 13501-1

Klass
A2-s1,d0

Toote klaasvillast põhiplaati on testitud ja klassifitseeritud kui mittepõlev vastavalt EN ISO 1182.



Niiskuskindlus

Klass

Class C, RH 95% and 30°C



Valguspegeldus

White 500, lähim NSC värvinäidis S 0500-N, 84% valguspegeldus.



Puhastatavus

Standard/meetod	Frequency
Tolmu pühkimine	Igapäevane
Märgpuhastus	Iganädalane
Aurupuhastus	4 korda aastas
Vesinikperoksiidi aur	•



Pinna vastupidavus

Toodet on testitud vastavalt standardile ISO 11998, peab vastu 200 tsükli.



Kemikaalitaluvus/desinfektsioon

Kemikaal	Toimeaine	Kontsentratsioon
Actichlor plus	NaDCC (Sodium Dichloroisocyanurate)	1%
LifeClean	Chlorine dioxide	Undiluted
Etanol	Ethanol	70%
Chlorine	Sodium Hypochlorite solution	2,5%
Virkon S	Sulfamic acid	1%
Isopropanol	Isopropyl Alcohol	70%
Acipusfoam VF59	Nitric Acid	5%

Testitud vastavalt standardile ISO 11998 ja peab vastu järnevate kemikaalide- või desinfektsiooni vahendite kasutamisele.



Hallituse- ja bakteriresistentsus

Standard/meetod	Klass
ISO 846 :2019 meetod C (bakteri jaoks)	0 (Mikroskoobi all ei ole kasvu)
ASTM D3273-16 (seente jaoks)	10 (0% kasv pinnal)



Puhasruum

	Standard/meetod	Klass
ISO 14644	Osakeste puhtuse klass	ISO 4
NF S 90-351	Mikrobioloogiline klass	M1/area 4
NF S 90-351	Osakeste kõrvaldamise kineetika	CP(0,5) 5



Avatavus

Plaadid ei ole avatavad.



Paigaldus

Paigaldus vastavalt paigaldusjoonistele, -juhenditele ja Drawing Aid järgi. Lõigatud plaadiservad tuleb viimistleda Connect servavärviga. Sisselõiked viimistleda sobiva viimistlusvahendiga.



Süsteemi kaal

	kg/m ²
Hygiene Performance B	3,7

Kaalu teave on indikatiivne ja võib muutuda.



Mehaanilised omadused

Lisakoormus peab olema kinnitatud aluslaele.



CE

Ecophoni laesüsteemid on CE-märgisega vastavalt Euroopa standardile EN13964:2014. CE-märgisega ehitustooted on hõlmatud toimusdeklaratsiooniga (Declarations of Performance - DOP), mis võimaldab klientidel ja kasutajatel kergesti võrrelda Euroopa turul olevaid tooteid.

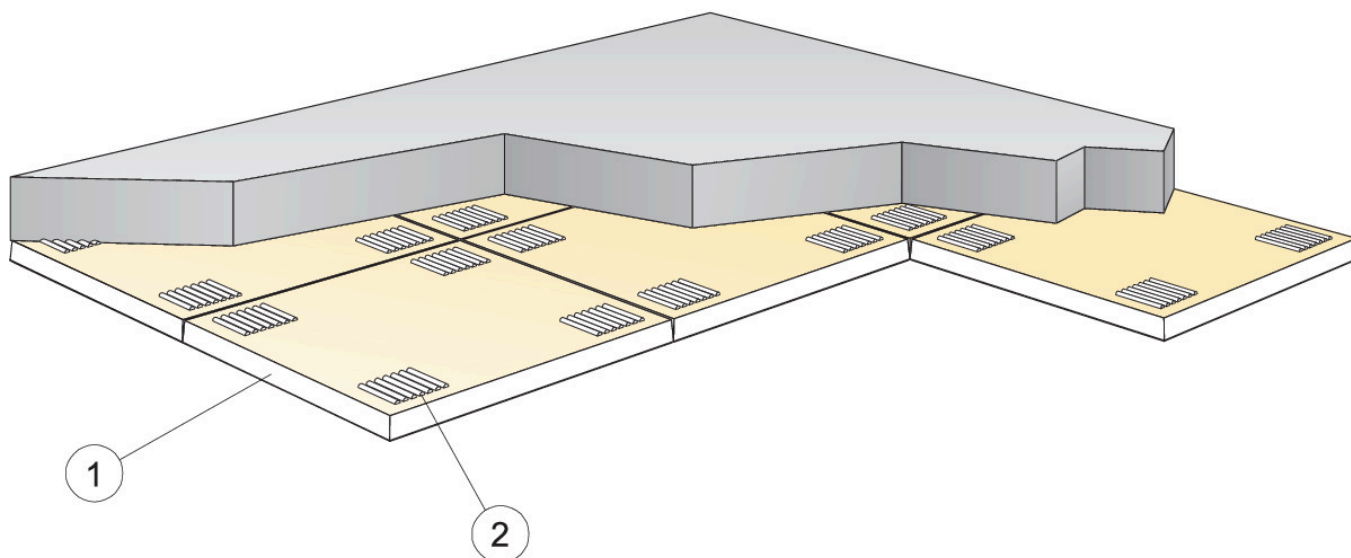

© Saint-Gobain Ecophon AB

KOGUSTE SPETSIFIKATSIOON (VALEMI JÄRGI)

	Mõõdud, mm	
	600x600	1200x600
1 Hygiene Performance™ B	2,8/m ²	1,4/m ²
2 Connect Absorber liim [0,25 l/m ² - 0,4 l/m ² sõltudes paigaldustingimustest]	vastavalt vajadusele	
liimi pealekandmiseks kasutage Connect liimikammi	-	-
Δ Min. süsteemi paigalduskõrgus: 43 mm	-	-
δ Min. avamise kõrgus: Süsteem ei ole avatav	-	-
Nähtavale jäävad lõigatud servad tuleks värvida	-	-

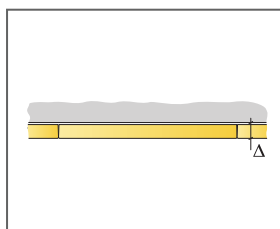

Vaata koguste spetsifikatsiooni

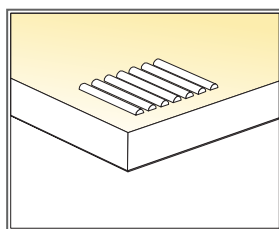

Liiman käyttö.

Mõõdud, mm	Max punktkoormus [N]	Max punktkoormuse kestvus [N]
600x600x40	-	-
1200x600x40	-	-

Punktkoormus/Punktkoormuse kestvus



Ecophon Hygiene Performance™ Ds

Ecophon Hygiene Performance™ Ds on peidetud liistudega rippplagi, kuid kus üksikud plaadid peavad olema kergesti demonteeritavad. Sobib basseinaladele ja väga niiskettesse piirkondadesse, kus esineb korrosiooni ja aeg-ajalt ka otsest kokkupuudet veega.



SÜSTEEMI INFO

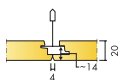

Möödud, mm	600x600
T24	•
Paksus (t)	20
Paigaldusjoonis	M616C4

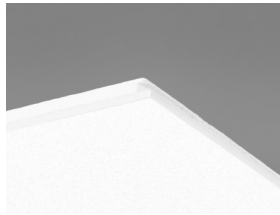

Performance Ds paneel

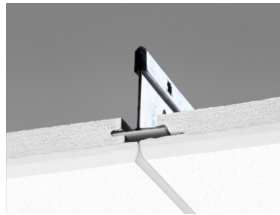

Performance Ds süsteemi seksioon koos Connect T24 kandur C4

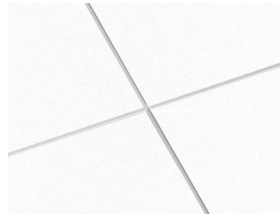

Performance Ds süsteem



Iga plaat on lihtsalt avatav

Akustika



Heli neeldumine:

Testi tulemused vastavalt: EN ISO 354.

Klassifikatsioon vastavalt: EN ISO 11654, ja üksikute väärtuste hinnangud NRC ja SAA kohta (Noise Reduction Coefficient ja Sound Absorption Average), vastavalt: ASTM C 423.

α_p , Praktiline helineelduvustegur

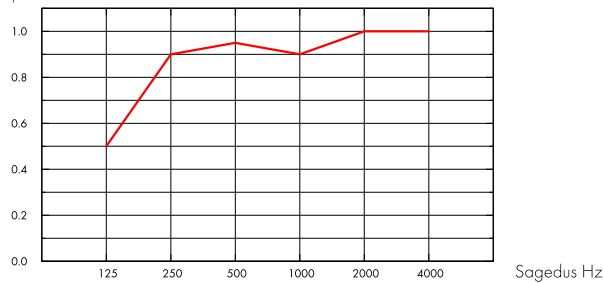

— Hygiene Performance Ds 20 mm, 200 mm o.d.s.

o.d.s = üldine süsteemi sügavus

t mm	o.d.s. mm	α_p , Praktiline helineelduvustegur						α_w	Helineeldumisklass
		125 Hz	250 Hz	500 Hz	1000 Hz	2000 Hz	4000 Hz		
20	200	0.50	0.90	0.95	0.90	1.00	1.00	0.95	A

t mm	o.d.s. mm	NRC	SAA
20	200	0.95	0.95

Siseõhu kvaliteet



Sertifikaat / Märkis

Prantsusmaa LOÜ

A

Soome M1

•



Süsiniku jalajälg



kg CO₂
equiv/m²

Elutsükli etapid A1 kuni C4 EPD-st, vastavalt standardile ISO 14025 / EN 15804

Hygiene Performance Ds (EN 15804+A2)

3,46



Taaskasutus

Minimaalne tarbijajõrgne taaskasutatud materjal	51%
Taaskasutus	Täielikult taaskasutatav



Tuleohutus

Riik	Tulestandard	Klass
Euroopa	EN 13501-1	A2-s1,d0

Toote klaasvillast põhiplaati on testitud ja klassifitseeritud kui mittepõlev vastavalt EN ISO 1182.



Niiskuskindlus

Testitud C-klassi puhul, suhteline õhuniiskus 95% ja 30°C, vastavalt EN 13964:2014



Valguspeegeldus

White 500, lähim NSC värvinäidis S 0500-N, 84% valguspeegeldus.



Puhastatavus

Standard/meetod	Frequency
Tolmu pühkimine	Igapäevane
Märgpuhastus	Iganädalane
Aurupuhastus	4 korda aastas
Vesinikperoksiidi aur	•



Pinna vastupidavus

Toodet on testitud vastavalt standardile ISO 11998, peab vastu 200 tsüklit.



Kemikaalitaluvus/desinfektsioon

Kemikaal	Toimeaine	Kontsentratsioon
Actichlor plus	NaDCC (Sodium Dichloroisocyanurate)	1%
LifeClean	Chlorine dioxide	Undiluted
Etanol	Ethanol	70%
Chlorine	Sodium Hypochlorite solution	2,5%
Virkon S	Sulfamic acid	1%
Isopropanol	Isopropyl Alcohol	70%
Acipusfoam VF59	Nitric Acid	5%

Testitud vastavalt standardile ISO 11998 ja peab vastu järnevate kemikaalide- või desinfektsiooni vahendite kasutamisele.



Hallituse- ja bakteriresistentsus

Standard/meetod	Klass
ISO 846 :2019 meetod C (bakteri jaoks)	0 (Mikroskoobi all ei ole kasvu)
ASTM D3273-16 (seente jaoks)	10 (0% kasv pinnal)



Puhasruum

Standard/meetod	Klass
ISO 14644	Osakeste puhtuse klass ISO 4
NF S 90-351	Mikrobioloogiline klass M1/area 4
NF S 90-351	Osakeste kõrvaldamise kineetika CP(0,5) 5



Avatavus

Plaadid on avatavad.



Paigaldus

Paigaldus vastavalt paigaldusjoonistele, -juhenditele ja Drawing Aid järgi. Lõigatud plaadiservad tuleb viimistleda Connect servavärviga. Sisselõiked viimistleda sobiva viimistlusvahendiga.



Süsteemi kaal

	kg/m ²
Hygiene Performance Ds	2,5
Hygiene Performance Ds + Connect grid system	3,4

Kaalu teave on indikatiivne ja võib muutuda.



Mehaanilised omadused

Infot Max punktkoormuse ja Min koormuskandevõime kohta vaata tabelist; tehnilisi tingimusi ja mehaanilisi omadusi vaata www.ecophon.ee.



CE

Ecophoni laesüsteemid on CE-märgisega vastavalt Euroopa standardile EN13964:2014. CE-märgisega ehitustooted on hõlmatud toimusdeklaratsiooniga (Declarations of Performance - DOP), mis võimaldab klientidel ja kasutajatel kergesti võrrelda Euroopa turul olevaid tooteid.

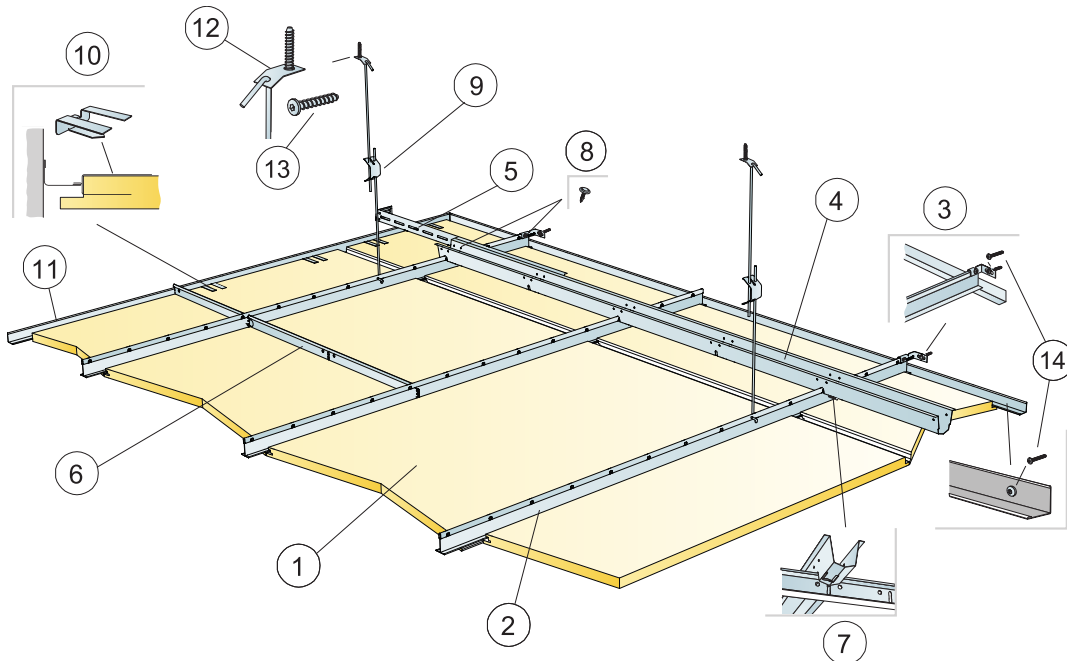

© Saint-Gobain Ecophon AB

KOGUSTE SPETSIFIKATSIOON (VALEMI JÄRGI)

		Mõõdud, mm
		600x600
1	Hygiene Performance Ds	2,8/m ²
2	Connect T24 kandur C4, paigaldus 600 mm tagant	1,7m/m ²
3	Connect T-profilide C4 seinakinniti	1/paigaldatud kanduri rivi kohta
4	Connect distantiprofil C4, paigaldus 1500 mm tagant (max. kaugus seinast 300 mm)	0,7m/m ²
5	Connect seinakinniti C4, L=700 mm, Connect distantiprofilile	1/iga distantislistu kohta
6	Connect T24 vaheliist C4, L=600 mm	2/kanduri rivi kohta
7	Connect distantiprofilil splint C4, üks iga Connect kanduri/Connect distantiprofilil liite kohta	1,4/m ²
8	C4 kruvi Wall Bracket'ile (tootega kaasas)	-
9	Connect reguleeritav riputi C4, paigaldus 1200 mm tagant (max kaugus seinast 600 mm)	0,7/m ²
10	Connect Support klips Dg20 C4	1tk/300-400 mm iga lõigatud äärepaneeli kohta, millel on 1 tugiserv
11	Connect L-servalist 15/22 C4, kinnitus 300 mm tagant	vastavalt vajadusele
12	Connect kinnitusplaat C4	0,7/m ²
13	Connect Anchor kruvi C4	0,7/m ²
14	Connect Paigalduskruvi C4	3,4/m U-liist C4
Δ Min. süsteemi paigalduskõrgus: 385 mm		-

δ Min. avamise kõrgus: 30 mm

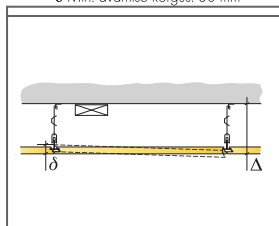

Vaata koguste spetsifikatsiooni

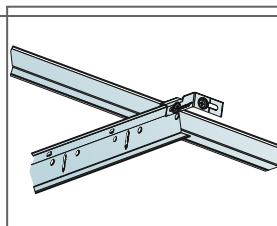

Turvatud Connect kandur C4 kinnitatus seinale Connect Wall Bracket C4 abil

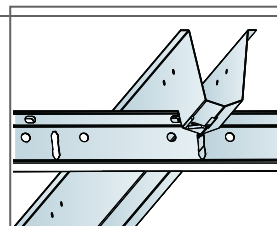

Profilide vaheline ühendus distantiprofilil splindi abil

Mõõdud, mm	Max punktikoormus [N]	Max punktikoormuse kestvus [N]
600x600x20	40	160

Punktkoormus/Punktikoormuse kestvus

Ecophon Hygiene Performance™ Plus A

Ecophon Hygiene Performance™ Plus A on nähtava liistu ja täielikult tihendatud tugevate Hygiene Performance™ Plus A plaatidega ning sobib niisketesse piirkondadesse. Lagi talub põhjalikku puhastamist, nagu regulaarne pesemine auru ja kõrg-/madalsurvepesuga. Pind talub levinud puhastus- ja desinfitseerimisvahendeid.



Oilly, Landskrona, Sweden

SÜSTEEMI INFO

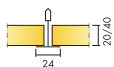

Mõõdud, mm	600x600	600x600	1200x600	1200x600
T24	•	•	•	•
Paksus (t)	20	40	20	40
Paigaldusjoonis	M466	M466	M466	M466

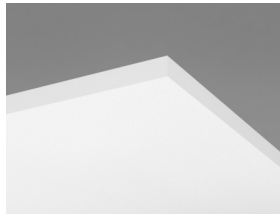

Hygiene Performance Plus A plaat

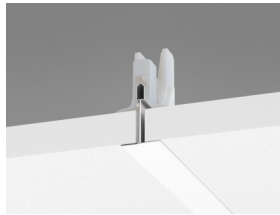

Hygiene Performance Plus A C3 sektsioon koos Connect Hygiene klips 20



Hygiene Performance Plus A süsteem

Akustika



Heli neeldumine:

Testi tulemused vastavalt: EN ISO 354.

Klassifikatsioon vastavalt: EN ISO 11654, ja üksikute väärtuste hinnangud NRC ja SAA kohta (Noise Reduction Coefficient ja Sound Absorption Average), vastavalt: ASTM C 423.

α_p , Praktiline helineelduvustegur

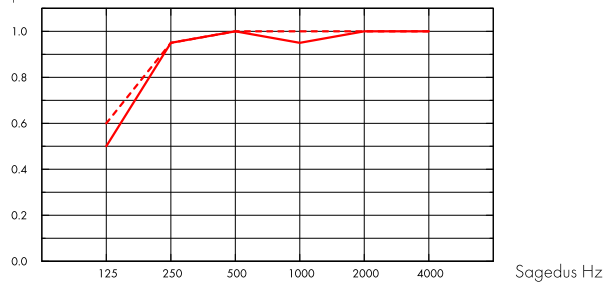

— Hygiene Performance Plus A 20 mm, 200 mm o.d.s.

- - - Hygiene Performance Plus A 40 mm, 200 mm o.d.s.

o.d.s = üldine süsteemi sügavus

t mm	o.d.s. mm	α_p , Praktiline helineelduvustegur						α_w	Helineeldumisklass
		125 Hz	250 Hz	500 Hz	1000 Hz	2000 Hz	4000 Hz		
20	200	0.50	0.95	1.00	0.95	1.00	1.00	1.00	A
40	200	0.60	0.95	1.00	1.00	1.00	1.00	1.00	A

t mm	o.d.s. mm	NRC	SAA
20	200	1.00	0.97
40	200	1.00	0.99

Siseõhu kvaliteet



Sertifikaat / Märgis

Prantsusmaa LOÜ

Soome M1

A



Cradle to Cradle Certified®



Sellel tootel on pronks taseme Cradle to Cradle Certified® sertifikaat (versioon 4.0).



Material Health

See toode on saanud C2C Certified Material Health Certificate™ hõbedase taseme (standardversioon 4.0). C2C Certified Material Health Certificate™ on toote koostise tervise ja ohutuse kinnitus, kasutades Cradle-to-Cradle Certified Product Standardi Material Health nõudeid.



Süsiniku jalajälg

	kg CO ₂ equiv/m ²	Elutsükli etapid A1 kuni C4 EPD-st, vastavalt standardile ISO 14025 / EN 15804
Hygiene Performance Plus A, 20mm	3,22	
Hygiene Performance Plus A, 40mm	5,19	



Taaskasutus

Minimaalne tarbijajärgne taaskasutatud materjal	44%
Taaskasutus	Täielikult taaskasutatav



Tuleohutus

Riik	Tulestandard	Klass	Toote klaasvillast põhiplaati on testitud ja klassifitseeritud kui mittepõlev vastavalt EN ISO 1182.
Euroopa	EN 13501-1	A2-s1,d0	



Niiskuskindlus

Klass D, suhteline õhuniiskus 97% ja 50 °C, vastavalt standardile EN 13964:2014



Valguspeegeldus

White 500, lähim NSC värvinäidis S 0500-N, 84% valguspeegeldus.



Puhastatavus

Standard/meetod	Frequency
Tolmu pühkimine	Igapäevane
Märgpuhastus	Iganädalane
Aurupuhastus	4 korda aastas
Madalsurvepuhastus	2 korda aastas
Kõrgsurvepuhastus	2 korda aastas
Vesinikperoksiidi aur	•



Pinna vastupidavus

Toodet on testitud vastavalt standardile ISO 11998, peab vastu 200 tsüklit.



Kemikaalitaluvus/desinfektsioon

Kemikaal	Toimeaine	Kontsentratsioon
Actichlor plus	NaDCC (Sodium Dichloroisocyanurate)	1%
LifeClean	Chlorine dioxide	Undiluted
Etanol	Ethanol	70%
Chlorine	Sodium Hypochlorite solution	2,5%
Virkon S	Sulfamic acid	1%
Isopropanol	Isopropyl Alcohol	70%
Acipusfoam VF59	Nitric Acid	5%

Testitud vastavalt standardile ISO 11998 ja peab vastu järnevate kemikaalide- või desinfektsiooni vahendite kasutamisele.



Hallituse- ja bakteriresistentsus

Standard/meetod	Klass
ISO 846 :2019 meetod C (bakteri jaoks)	0 (Mikroskoobi all ei ole kasvu)
ASTM D3273-16 (seente jaoks)	10 (0% kasv pinnal)



Puhasruum

Standard/meetod	Klass
ISO 14644	Osakeste puhtuse klass ISO 4
NF S 90-351	Mikrobioloogiline klass M1/area 4
NF S 90-351	Osakeste kõrvaldamise kineetika CP(0,5) 5



Paigaldus

Paigaldus vastavalt paigaldusjoonistele, -juhenditele ja Drawing Aid järgi. Lõigatud plaadiservad tuleb viimistleda Connect servavärviga. Sisselõiked viimistleda sobiva viimistlusvahendiga.



Avatavus

Plaadid on avatavad. Minimaalne avamise kõrgus vastavalt paigaldusjoonisele. Plaadid on kinnitatud klipsidega, et tagada efektiivne puhastatavus. Klipsid on lihtsalt eemaldatavad lae pealtpoolt. Lihtsalt avatavat Connect hooldusluuki kasutatakse lihtsustamiseks pääsemist lae peale.



Süsteemi kaal

	kg/m ²
Hygiene Performance Plus A 20 mm	1,5
Hygiene Performance Plus A 20 mm + Connect grid system	2,5
Hygiene Performance Plus A 40 mm	2,5
Hygiene Performance Plus A 40 mm+ Connect grid system	3,5

Kaalu teave on indikatiivne ja võib muutuda.



Mehaanilised omadused

Infot Max punktkoormuse ja Min koormuskandevõime kohta vaata tabelist; tehnilisi tingimusi ja mehaanilisi omadusi vaata www.ecophon.ee.



CE

Ecophoni laesüsteemid on CE-märgisega vastavalt Euroopa standardile EN13964:2014. CE-märgisega ehitustooted on hõlmatud toimivusdeklaratsiooniga (Declarations of Performance - DOP), mis võimaldab klientidel ja kasutajatel kergesti võrrelda Euroopa turul olevaid tooteid.

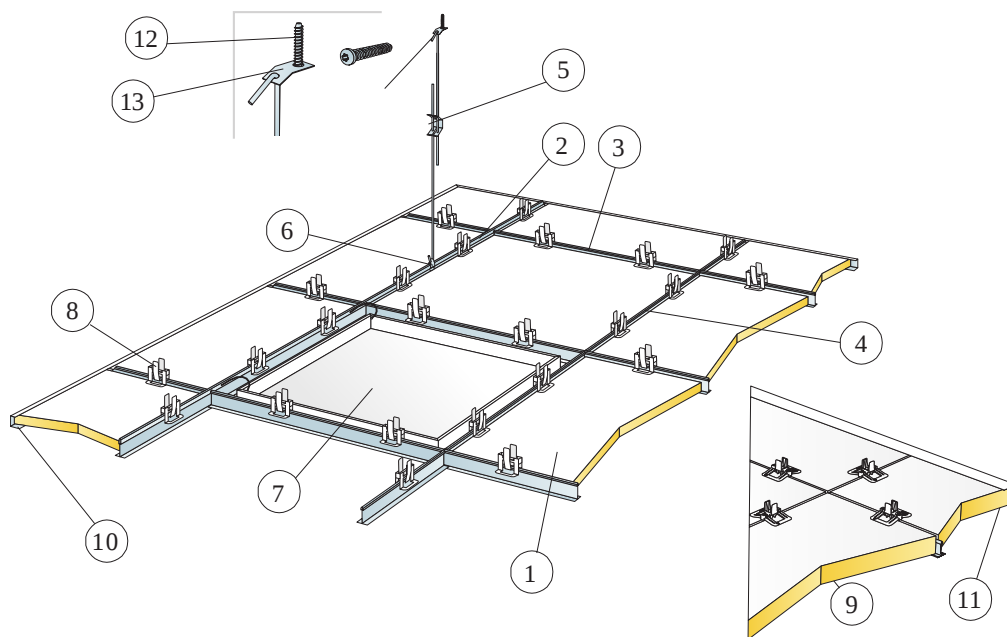

© Saint-Gobain Ecophon AB

KOGUSTE SPETSIFIKATSIOON (VALEMI JÄRGI)

	Mõõdud, mm	
	600x600	1200x600
1 Hygiene Performance Plus A	2,8/m ²	1,4/m ²
2 Connect T24 kandur C3, paigaldus 1200 mm tagant	0,9m/m ²	0,9m/m ²
3 Connect T24 vahelist C3, L=1200 mm, paigaldus 600 mm tagant	1,7m/m ²	1,7m/m ²
4 Connect T24 vahelist C3, L=600 mm	0,9m/m ²	-
5 Connect reguleeritav riputi C3, c1200 (max kaugus seinast 600 mm)	0,7/m ²	0,7/m ²
6 Connect riputi klips (mitte kasutada ujula keskkonnas)	0,7/m ²	0,7/m ²
7 Connect hooldusluuk C3	vastavalt vajadusele	
8 Connect Hygiene klips 20	11/m ²	7/m ²
9 Connect Hygiene klips 40	11/m ²	7/m ²
10 Connect U-list C3, kinnitus c300 (20 mm plaadile)	vastavalt vajadusele	
11 Connect U-list C3, kinnitus c300 (40 mm plaadile)	vastavalt vajadusele	
12 Connect Anchor kruvi C4	0,7/m ²	0,7/m ²
13 Connect kinnitusplaat C4	0,7/m ²	0,7/m ²
Δ Min. süsteemi paigalduskõrgus: 150 mm	-	-
δ Min. avamise kõrgus 20 mm: 150 mm	-	-
δ Min. avamise kõrgus 40 mm: 170 mm	-	-

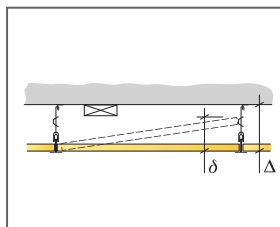

Vaata koguste spetsifikatsiooni

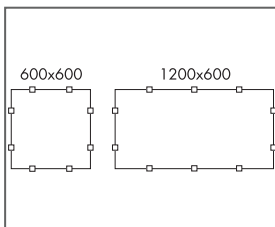

Klipside paigutus

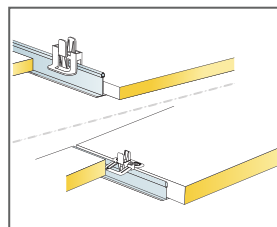

Klipsid plaatide paigaldamiseks. 20/40 mm plaatidele.

Mõõdud, mm	Max punktkoormus [N]	Max punktkoormuse kestvus [N]
600x600x20	50	160
600x600x40	50	160
1200x600x20	50	160
1200x600x40	50	160

Punktkoormus/Punktkoormuse kestvus plaatidele.

Ecophon Hygiene Performance™ Baffle

Ecophon Hygiene Performance™ Baffle on kergesti puhastatav heli neelav süsteem, mille vertikaalsed ripp-paneelid sobivad niisketesse piirkondadesse. Ripp-paneelid taluvad põhjalikku puhastamist, nagu regulaarne pesemine auru ja kõrg-/madalsurvepesuga.



SÜSTEEMI INFO



Möödud, mm	1200x600
T24	•
Paksus (t)	50
Paigaldusjoonis	M492C3, M493C3, M494C4

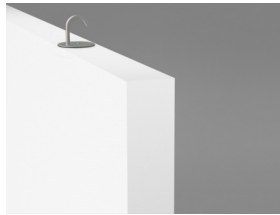

Solo Baffle/konks

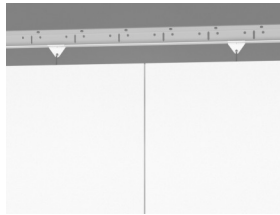

Hygiene Performance Baffle C4

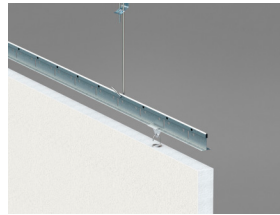

Hygiene Performance Baffle C4 paigaldus

Akustika



Heli neeldumine:

Testitulemused vastavalt: EN ISO 354:2003 MÄRKUS: Näidatud tulemused ei ole võrreldavad standardi vanema versiooni tulemustega erinevuste tõttu testimise meetodis. Klassifikatsioon vastavalt: EN ISO 11654, ja üksikute väärtuste hinnangud NRC ja SAA kohta (Noise Reduction Coefficient ja Sound Absorption Average), vastavalt: ASTM C 423.

α_p , Praktiline helineelduvustegur

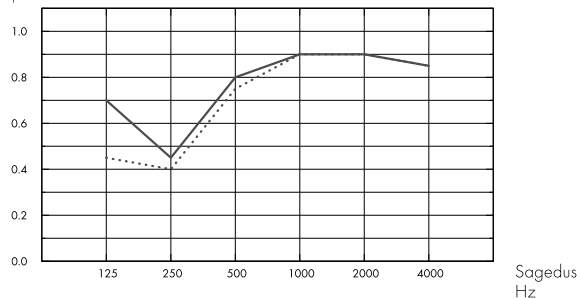

... Performance Baffle reas, c600 mm, ~1,4 Baffle't ruutmeetri kohta, 600 mm o.d.s.

– Performance Baffle riskülikutena, ~1,3 Baffle't ruutmeetri kohta, 600 mm o.d.s.

o.d.s = üldine süsteemi sügavus

	t mm	o.d.s. mm	α_p , Praktiline helineelduvustegur					α_w	Helineeldumisklass	
			125 Hz	250 Hz	500 Hz	1000 Hz	2000 Hz			4000 Hz
in rows	50	600	0.45	0.40	0.75	0.90	0.90	0.85	0.70	C
in rectangles	50	600	0.70	0.45	0.80	0.90	0.90	0.85	0.75	C

	t mm	o.d.s. mm	NRC	SAA
in rows	50	600	0.75	0.73
in rectangles	50	600	0.75	0.77

Siseõhu kvaliteet



Sertifikaat / Märgis

Eurofins Indoor Air Comfort®

IAC Gold

Prantsusmaa LOÜ

A+



Cradle to Cradle Certified®



Sellel tootel on pronks taseme Cradle to Cradle Certified® sertifikaat (versioon 4.0).



Material Health

See toode on saanud C2C Certified Material Health Certificate™ hõbedase taseme (standardversioon 4.0). C2C Certified Material Health Certificate™ on toote koostise tervise ja ohutuse kinnitus, kasutades Cradle-to-Cradle Certified Product Standardi Material Health nõudeid.



Süsiniku jalajälg

	kg CO ₂ equiv/m ²	Elutsükli etapid A1 kuni C4 EPD-st, vastavalt standardile ISO 14025 / EN 15804
Hygiene Performance Baffle	8,30	



Taaskasutus

Minimaalne tarbijajärgne taaskasutatud materjal	57%
Taaskasutus	Täielikult taaskasutatav



Tuleohutus

Riik	Tulestandard	Klass	Toote klaasvillast põhiplaati on testitud ja klassifitseeritud kui mittepõlev vastavalt EN ISO 1182.
Euroopa	EN 13501-1	A2-s1,d0	



Niiskuskindlus

Testitud C-klassi puhul, suhteline õhuniiskus 95% ja 30°C, vastavalt EN 13964:2014



Valguspeegeldus

White 500, lähim NSC värvinäidis S 0500-N, 84% valguspeegeldus.



Puhastatavus

Standard/meetod	Frequency
Tolmu pühkimine	Igapäevane
Märgpuhastus	Iganädalane
Aurupuhastus	4 korda aastas
Madalsurvepuhastus	2 korda aastas
Kõrgsurvepuhastus	2 korda aastas
Vesinikperoksiidi aur	•



Pinna vastupidavus

Toodet on testitud vastavalt standardile ISO 11998, peab vastu 200 tsükli.



Kemikaalitaluvus/desinfektsioon

Kemikaal	Toimeaine	Kontsentratsioon
Actichlor plus	NaDCC (Sodium Dichloroisocyanurate)	1%
LifeClean	Chlorine dioxide	Undiluted
Etanol	Ethanol	70%
Chlorine	Sodium Hypochlorite solution	2,5%
Virkon S	Sulfamic acid	1%
Isopropanol	Isopropyl Alcohol	70%
Acipusfoam VF59	Nitric Acid	5%

Testitud vastavalt standardile ISO 11998 ja peab vastu järnevate kemikaalide- või desinfektsiooni vahendite kasutamisele.



Hallituse- ja bakteriresistentsus

Standard/meetod	Klass
ISO 846 :2019 meetod C (bakteri jaoks)	0 (Mikroskoobi all ei ole kasvu)
ASTM D3273-16 (seente jaoks)	10 (0% kasv pinnal)



Puhasruum

Standard/meetod	Klass
ISO 14644	Osakeste puhtuse klass ISO 4
NF S 90-351	Mikrobioloogiline klass M1/area 4
NF S 90-351	Osakeste kõrvaldamise kineetika CP(0,5) 5



Avatavus

Plaadid on avatavad.



Paigaldus

Paigaldus vastavalt paigaldusjoonistele, -juhenditele ja Drawing Aid järgi. Lõigatud pladiservad viimistletakse Connect servavärviga. Sisselõiked viimistleda sobiva värviga.



Süsteemi kaal

	kg/m ²
Hygiene Performance Baffle	4,8

Kaalu teave on indikatiivne ja võib muutuda.



Mehaanilised omadused

Pange tähele, et vibratsioon, õhuvool ja muud mehaanilised mõjud, mõjutavad kinnitusdetailide tehnilisi omadusi.



CE

Ecophoni laesüsteemid on CE-märgisega vastavalt Euroopa standardile EN13964:2014. CE-märgisega ehitustooted on hõlmatud toimusdeklaratsiooniga (Declarations of Performance - DOP), mis võimaldab klientidel ja kasutajatel kergesti võrrelda Euroopa turul olevaid tooteid.

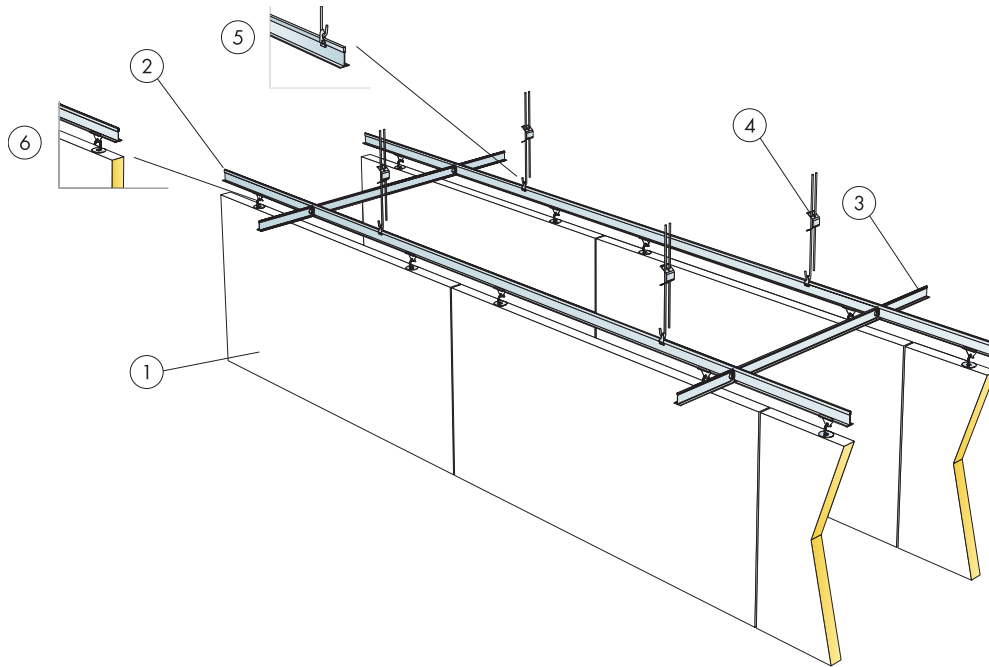

© Saint-Gobain Ecophon AB

KOGUSTE SPETSIFIKATSIOON (VALEMI JÄRGI)

		Mõõdud, mm
		1200x600
1	Hygiene Performance Baffle	1,4/m ²
2	Connect T24 kandur C3, paigaldus 600 mm tagant	1,7m/m ²
3	Connect T24 vahelist C3, L=600 mm, paigaldus 1800 mm tagant	0,6m/m ²
4	Connect reguleeritav riputi C3 c1200	1,4/m ²
5	Connect riputi klips	1,4/m ²
6	Connect Baffle klips C3	2,8/m ²

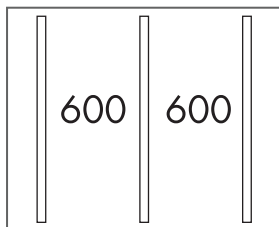

Paigaldus ridadena

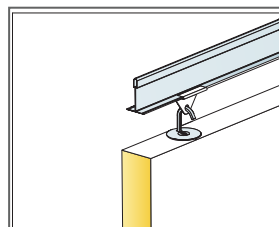

Riputusdetail

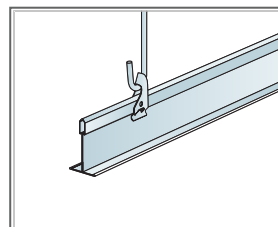

Riputus Connect reguleeritava riputi ja Connect klipsiga

Mõõdud, mm	Max punktkoormus [N]	Max punktkoormuse kestvus [N]
1200x600x50	0	160

Punktkoormus/Punktkoormuse kestvus

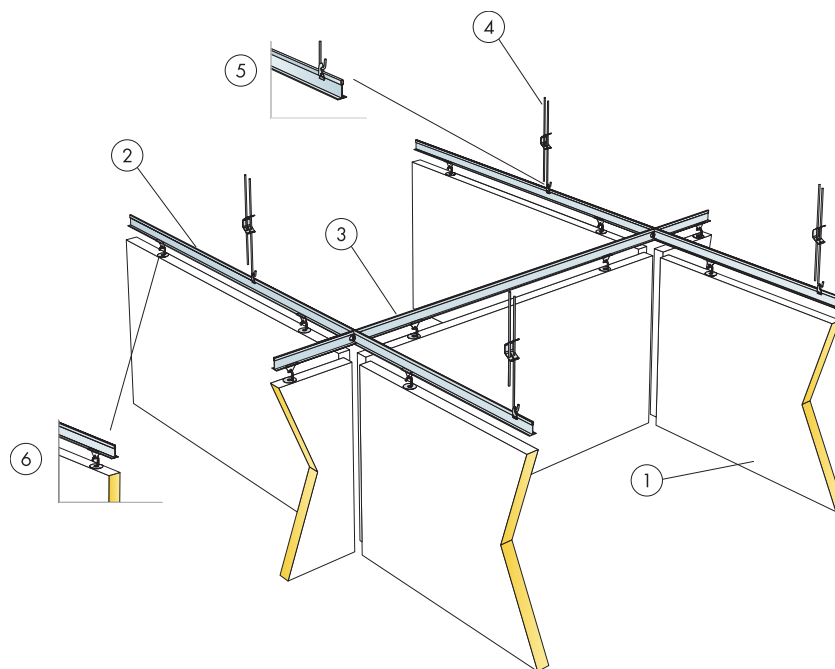

© Saint-Gobain Ecophon AB

KOGUSTE SPETSIFIKATSIOON (VALEMI JÄRGI)

		Mõõdud, mm
		1200x600
1	Hygiene Performance Baffle	1,3/m ²
2	Connect T24 kandur C3, paigaldus 1250 mm tagant	0,8m/m ²
3	Connect T24 vaheliist C3, L=1250 mm, paigaldus 1300 mm tagant	0,8m/m ²
4	Connect reguleeritav riputi C3	0,7/m ²
5	Connect riputi klips	0,7/m ²
6	Connect Baffle klips C3	2,5/m ²

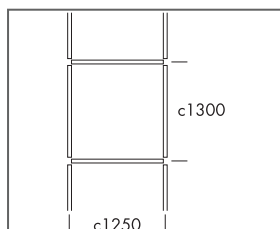

Paigaldus ruutudena

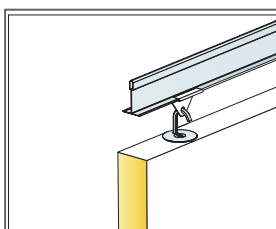

Riputusdetail

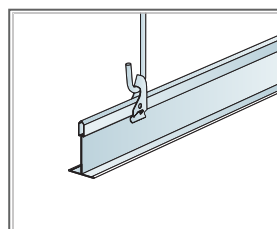

Riputus Connect reguleeritava riputi ja Connect klipsisiga

Mõõdud, mm	Max punktkoormus [N]	Max punktkoormuse kestvus [N]
1200x600x50	0	160

Punktkoormus/Punktkoormuse kestvus

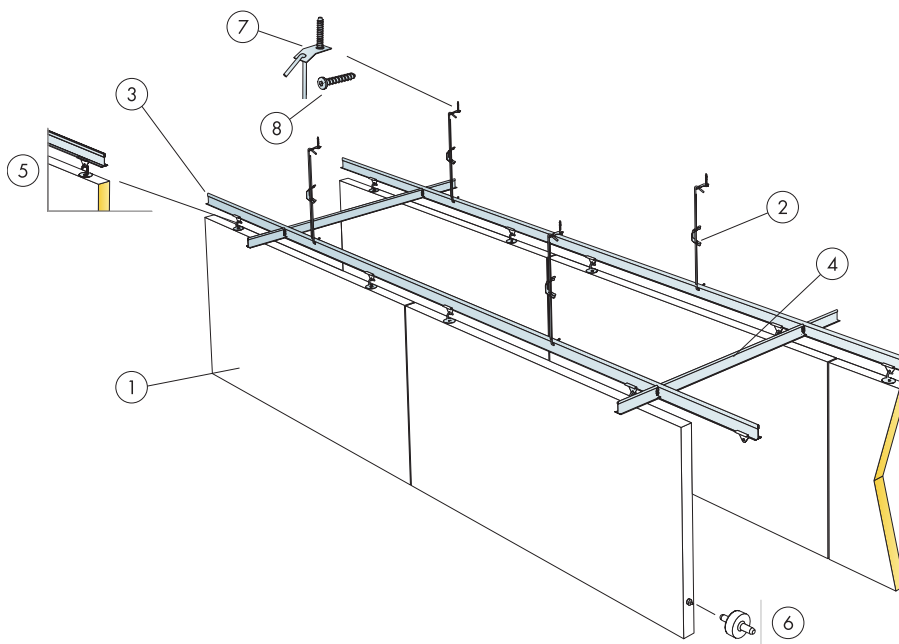

© Saint-Gobain Ecophon AB

KOGUSTE SPETSIFIKATSIOON (VALEMI JÄRGI)

		Mõõdud, mm
		1200x600
1	Hygiene Performance Baffle	1,4/m ²
2	Connect reguleeritav riputi C4 c1200	1,4/m ²
3	Connect T24 kanalur C4, paigaldus 600 mm tagant	1,7m/m ²
4	Connect T24 vaheliist C4, L=600 mm, paigaldus 1800 mm tagant	0,6m/m ²
5	Connect Baffle klips C4	2,8/m ²
6	Connect Juhtpuks, paigaldus 1200/1800 mm tagant	2,8/m ²
7	Connect kinnitusplaat C4	1,4/m ²
8	Connect Anchor kruvi C4	1,4/m ²

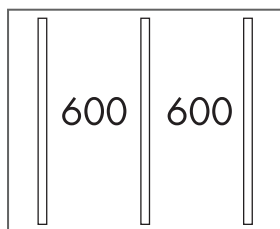

Paigaldus ridadena

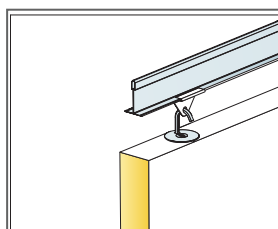

Riputusdetail

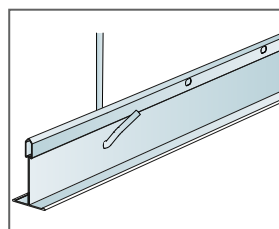

Paigaldus C4 Connect reguleeritava riputiga

Mõõdud, mm	Max punktkoormus [N]	Max punktkoormuse kestvus [N]
1200x600x50	0	160

Punktkoormus/Punktkoormuse kestvus

Ecophon Hygiene Performance™ Wall

Ecophon Hygiene Performance™ Wall on kergesti puhastatav heli neelav seinapaneelide süsteem, mis sobib niisketesse piirkondadesse. Paneelid taluvad põhjalikku puhastamist, nagu regulaarne pesemine arvu ja kõrg-/madalsurvepesuga.



TAYS kitchen, Tampere, Finland

SÜSTEEMI INFO

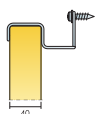

Möödud, mm	1200x600
Spetsiaalkinnitus	•
Paksus (t)	40
Paigaldusjoonis	M467

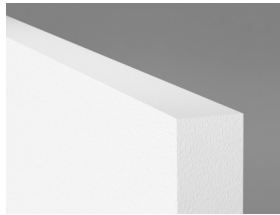

Hygiene Performance Wall

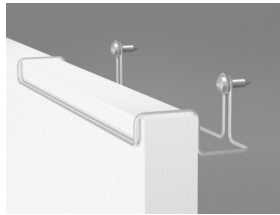

Connect seinakinnitus C3



Hygiene Performance Wall C3 süsteem

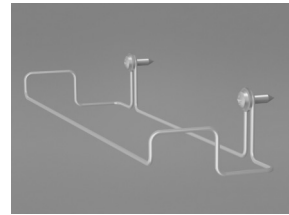

Connect seinakinnitus C3

Akustika



Heli neeldumine:

Testitulemused vastavalt: EN ISO 354. Klassifikatsioon vastavalt: EN ISO 11654.

α_p , Praktiline helineelduvustegur

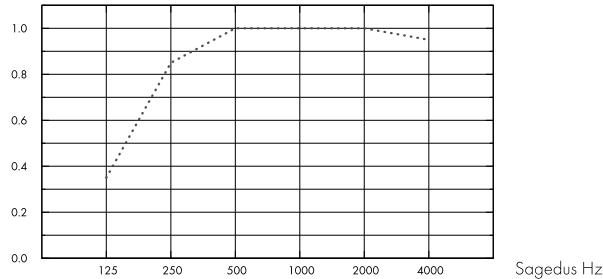

... Hygiene Performance Wall, 80 mm o.d.s.

o.d.s = üldine süsteemi sügavus

t mm	o.d.s. mm	α_p , Praktiline helineelduvustegur						α_w	Helineeldumisklass
		125 Hz	250 Hz	500 Hz	1000 Hz	2000 Hz	4000 Hz		
40	80	0.35	0.85	1.00	1.00	1.00	0.95	1.00	A

t mm	o.d.s. mm	NRC	SAA
40	80	0.95	0.95

Siseõhu kvaliteet



Sertifikaat / Märgis	
Prantsusmaa LOÜ	A
Soome M1	•



Cradle to Cradle Certified®



Sellel tootel on pronks taseme Cradle to Cradle Certified® sertifikaat (versioon 4.0).



Material Health

See toode on saanud C2C Certified Material Health Certificate™ hõbedase taseme (standardversioon 4.0). C2C Certified Material Health Certificate™ on toote koostise tervise ja ohutuse kinnitus, kasutades Cradle-to-Cradle Certified Product Standardi Material Health nõudeid.



Süsiniku jalajälg

	kg CO ₂ equiv/m ²	Elutsükli etapid A1 kuni C4 EPD-st, vastavalt standardile ISO 14025 / EN 15804
Hygiene Performance Wall	7,13	



Taaskasutus

Minimaalne tarbijajõrgne taaskasutatud materjal	54%
Taaskasutus	Täielikult taaskasutatav



Tuleohutus

Riik	Tulestandard	Klass
Euroopa	EN 13501-1	A2-s1,d0

Toote klaasvillast põhiplaati on testitud ja klassifitseeritud kui mittepõlev vastavalt EN ISO 1182.



Niiskuskindlus

Testitud C-klassi puhul, suhteline õhuniiskus 95% ja 30°C, vastavalt EN 13964:2014



Valguspeegeldus

White 500, lähim NSC värvinäidis S 0500-N, 84% valguspeegeldus.



Puhastatavus

Standard/meetod	Frequency
Tolmu pühkimine	Igapäevane
Märgpuhastus	Iganädalane
Aurupuhastus	4 korda aastas
Madalsurvepuhastus	2 korda aastas
Kõrgsurvepuhastus	2 korda aastas
Vesinikperoksiidi aur	•



Pinna vastupidavus

Toodet on testitud vastavalt standardile ISO 11998, peab vastu 200 tsükli.



Kemikaalitaluvus/desinfektsioon

Kemikaal	Toimeaine	Kontsentratsioon
Actichlor plus	NaDCC (Sodium Dichloroisocyanurate)	1%
LifeClean	Chlorine dioxide	Undiluted
Etanol	Ethanol	70%
Chlorine	Sodium Hypochlorite solution	2,5%
Virkon S	Sulfamic acid	1%
Isopropanol	Isopropyl Alcohol	70%
Acipusfoam VF59	Nitric Acid	5%

Testitud vastavalt standardile ISO 11998 ja peab vastu järnevate kemikaalide- või desinfektsiooni vahendite kasutamisele.



Hallituse- ja bakteriresistentsus

Standard/meetod	Klass
ISO 846 :2019 meetod C (bakteri jaoks)	0 (Mikroskoobi all ei ole kasvu)
ASTM D3273-16 (seente jaoks)	10 (0% kasv pinnal)



Puhasruum

	Standard/meetod	Klass
ISO 14644	Osakeste puhtuse klass	ISO 4
NF S 90-351	Mikrobioloogiline klass	M1/area 4
NF S 90-351	Osakeste kõrvaldamise kineetika	CP(0,5) 5



Avatavus

Plaadid on avatavad.



Paigaldus

Paigaldus vastavalt paigaldusjoonistele, -juhenditele ja Drawing Aid järgi. Infot minimaalse süsteemi paigalduskõrguse kohta vaata koguste spetsifikatsioonist.



Süsteemi kaal

	kg/m ²	Kaalu teave on indikatiivne ja võib muutuda.
Hygiene Performance Wall	4,0	



Mehaanilised omadused

Infot Max punktkoormuse ja Min koormuskandevõime kohta vaata tabelist; tehnilisi tingimusi ja mehaanilisi omadusi vaata www.ecophon.ee.



CE

Ecophoni laesüsteemid on CE-märgisega vastavalt Euroopa standardile EN13964:2014. CE-märgisega ehitustooted on hõlmatud toimusdeklaratsiooniga (Declarations of Performance - DOP), mis võimaldab klientidel ja kasutajatel kergesti võrrelda Euroopa turul olevaid tooteid.

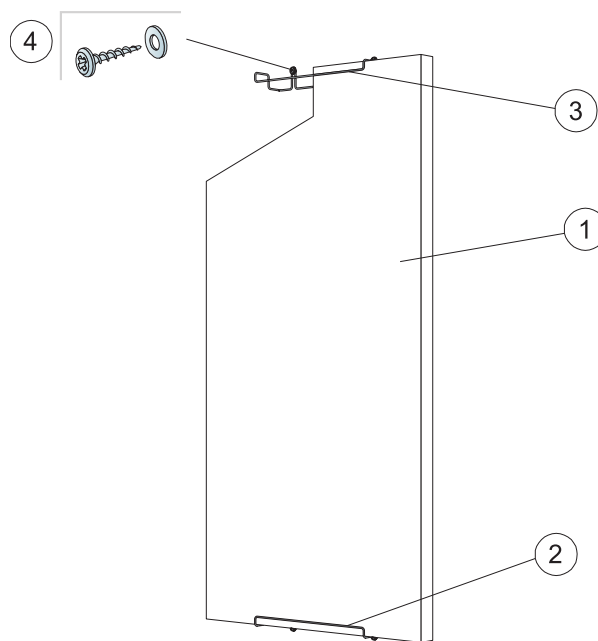

© Saint-Gobain Ecophon AB

KOGUSTE SPETSIFIKATSIOON (VALEMI JÄRGI)

		Mõõdud, mm
		1200x600
1	Hygiene Performance Wall	1,4/m ²
2	Connect seinakinnitus C3, vertikaalseks paigalduseks	2/paneeli kohta
3	Connect seinakinnitus C3, horisontaalseks paigalduseks	4/paneeli kohta
4	Seinakruvi, A2 materjal (ei kuulu Ecophoni tootevalikusse)	2/seinakinnitus
Δ Min. süsteemi paigalduskõrgus: 90 mm		-

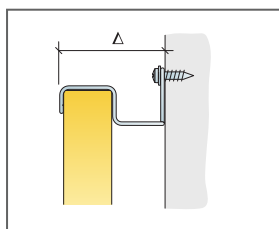

Vaata koguste spetsifikatsiooni

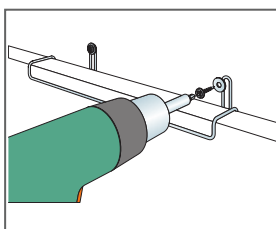

Paigaldus roostevabast terasest (A2) seinakruvidega

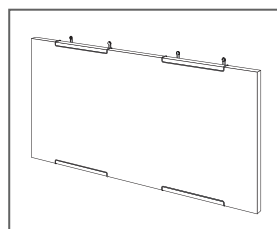

Performance Wall C3 horisontaalne paigaldus

Mõõdud, mm	Max punktkoormus [N]	Max punktkoormuse kestvus [N]
1200x600x40	0	-

Punktkoormus/Punktkoormuse kestvus



Ecophon Hygiene Performance™ Care Wall

Ecophon Hygiene Performance™ Care Wall on kergesti puhastatav seinapaneelide süsteem tervishoiuasutustele või muudele piirkondadele, kus kehtivad ranged hügieeninormid. Pind talub levinud puhastus- ja desinfitseerimisvahendeid. Paneelid taluvad auruga puhastamist.



Healthcare launch 2019, Sweden

SÜSTEEMI INFO

 Mõõdud, mm	2700x1200
Thinline profiil	•
Paksus (t)	40
Paigaldusjoonis	M610

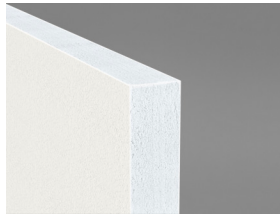

Hygiene Performance Care Wall



Hygiene Performance Care Wall system with Connect Thinline profiles

Akustika



Heli neeldumine:

Testitulemused vastavalt: EN ISO 354. Klassifikatsioon vastavalt: EN ISO 11654.

α_p , Praktiline helineelduvustegur

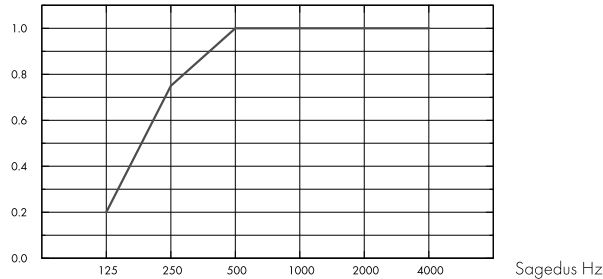

– Hygiene Performance Care Wall 40 mm, 50 mm o.d.s.

o.d.s = üldine süsteemi sügavus

t mm	o.d.s. mm	α_p , Praktiline helineelduvustegur						α_w	Helineeldumisklass
		125 Hz	250 Hz	500 Hz	1000 Hz	2000 Hz	4000 Hz		
40	50	0.20	0.75	1.00	1.00	1.00	1.00	1.00	A

t mm	o.d.s. mm	NRC	SAA
40	50	0.95	0.96

Siseõhu kvaliteet



Sertifikaat / Märgis

Eurofins Indoor Air Comfort®

IAC Gold

Prantsusmaa LOÜ

A+



Cradle to Cradle Certified®



Sellel tootel on pronks taseme Cradle to Cradle Certified® sertifikaat (versioon 4.0).



Material Health

See toode on saanud C2C Certified Material Health Certificate™ hõbedase taseme (standardversioon 4.0). C2C Certified Material Health Certificate™ on toote koostise tervise ja ohutuse kinnitus, kasutades Cradle-to-Cradle Certified Product Standardi Material Health nõudeid.



Taaskasutus

Minimaalne tarbijajärgne taaskasutatud materjal

58%



Tuleohutus

Riik	Tulestandard	Klass
Euroopa	EN 13501-1	A2-s1,d0

Toote klaasvillast põhiplaati on testitud ja klassifitseeritud kui mittepõlev vastavalt EN ISO 1182.



Niiskuskindlus

Testitud C-klassi puhul, suhteline õhuniiskus 95% ja 30°C, vastavalt EN 13964:2014



Valguspeegeldus

White 500, lähim NSC värvinäidis S 0500-N, 84% valguspeegeldus.



Puhastatavus

Standard/meetod	Frequency
Tolmu pühkimine	Igapäevane
Märgpuhastus	Iganädalane
Aurupuhastus	4 korda aastas
Vesinikperoksiidi aur	•



Pinna vastupidavus

Toodet on testitud vastavalt standardile ISO 11998, peab vastu 200 tsükli.



Kemikaalitaluvus/desinfektsioon

Kemikaal	Toimeaine	Kontsentratsioon
Actichlor plus	NaDCC (Sodium Dichloroisocyanurate)	1%
LifeClean	Chlorine dioxide	Undiluted
Etanol	Ethanol	70%
Chlorine	Sodium Hypochlorite solution	2,5%
Virkon S	Sulfamic acid	1%
Isopropanol	Isopropyl Alcohol	70%
Acipusfoam VF59	Nitric Acid	5%

Testitud vastavalt standardile ISO 11998 ja peab vastu järnevate kemikaalide- või desinfektsiooni vahendite kasutamisele.



Hallituse- ja bakteriresistentsus

Standard/meetod	Klass
ISO 846 :2019 meetod C (bakteri jaoks)	0 (Mikroskoobi all ei ole kasvu)
ASTM D3273-16 (seente jaoks)	10 (0% kasv pinnal)



Puhasruum

	Standard/meetod	Klass
ISO 14644	Osakeste puhtuse klass	ISO 4
NF S 90-351	Mikrobioloogiline klass	M1/area 4
NF S 90-351	Osakeste kõrvaldamise kineetika	CP(0,5) 5



Avatavus

Plaadid ei ole avatavad v.a teatud paigaldusjooniste puhul. Lisainfo saamiseks vaata koguste spetsifikatsiooni.



Süsteemi kaal

	kg/m ²	Kaalu teave on indikatiivne ja võib muutuda.
Hygiene Performance Care Wall	3,7	



Paigaldus

Paigaldus vastavalt paigaldusjoonistele, -juhenditele ja Drawing Aid järgi. Infot minimaalse süsteemi paigalduskõrguse kohta vaata koguste spetsifikatsioonist.



Mehaanilised omadused

Infot Max punktkoormuse ja Min koormuskandevõime kohta vaata tabelist; tehnilisi tingimusi ja mehaanilisi omadusi vaata www.ecophon.ee.



CE

Ecophoni laesüsteemid on CE-märgisega vastavalt Euroopa standardile EN13964:2014. CE-märgisega ehitustooted on hõlmatud toimivusdeklaratsiooniga (Declarations of Performance - DOP), mis võimaldab klientidel ja kasutajatel kergesti võrrelda Euroopa turul olevaid tooteid.

Taaskasutus

Täielikult taaskasutatav

PAIGALDUSJÕONIS (M610) HYGIENE PERFORMANCE™ CARE WALL PAIGALDAMISEKS CONNECT THINLINE PROFIIILIGA.

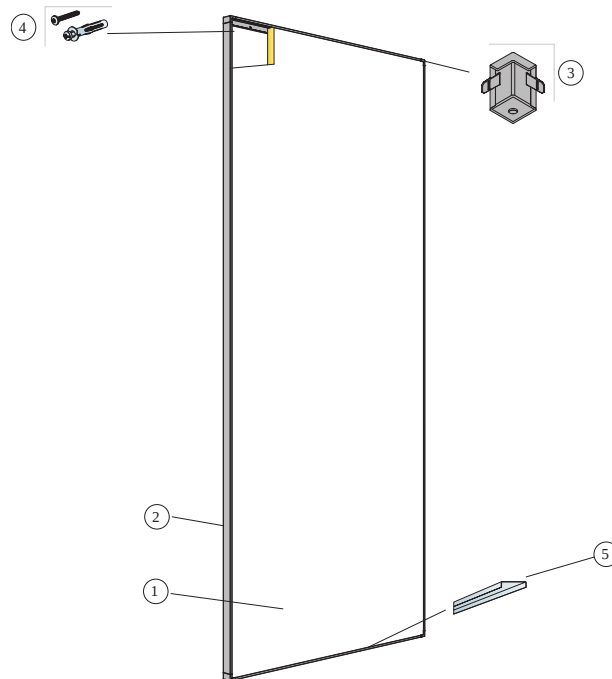

© Saint Gobain Ecophon AB

KOGUSTE SPETSIFIKATSIOON (VALEMI JÄRGI)

	Mõõdud, mm
	2700x1200
1 Hygiene Performance Care Wall	0,31/m ²
2 Connect Thinline profiil, L=2658 mm	vastavalt vajadusele
3 Connect Thinline nurk	vastavalt vajadusele
4 Paigalduskruvi, paigaldus 200 mm tagant (vali kinniti vastavalt seinamaterjalile)	vastavalt vajadusele
5	vastavalt vajadusele
Δ Süsteemi paigalduskõrgus: 45 mm	-

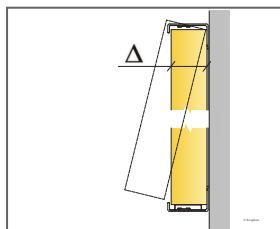

Vaata koguste spetsifikatsiooni

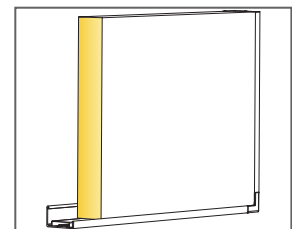

Paneeli ja Thinline süsteemi detail

Ecophon Hygiene Advance™

A

Ecophon Hygiene Advance™ A on nähtava liistuga heli neelav lagi, mis talub igapäevast põhjalikku puhastamist ja desinfitseerimist tugevate kemikaalidega. Sobib ka kõige nõudlikumatesse tingimustesse. Saadaval niisketele piirkondadele mõeldud liistudega, mille korrosiooniklass on C3, ja liistudega C4, mis on mõeldud pidevalt märgadele piirkondadele.

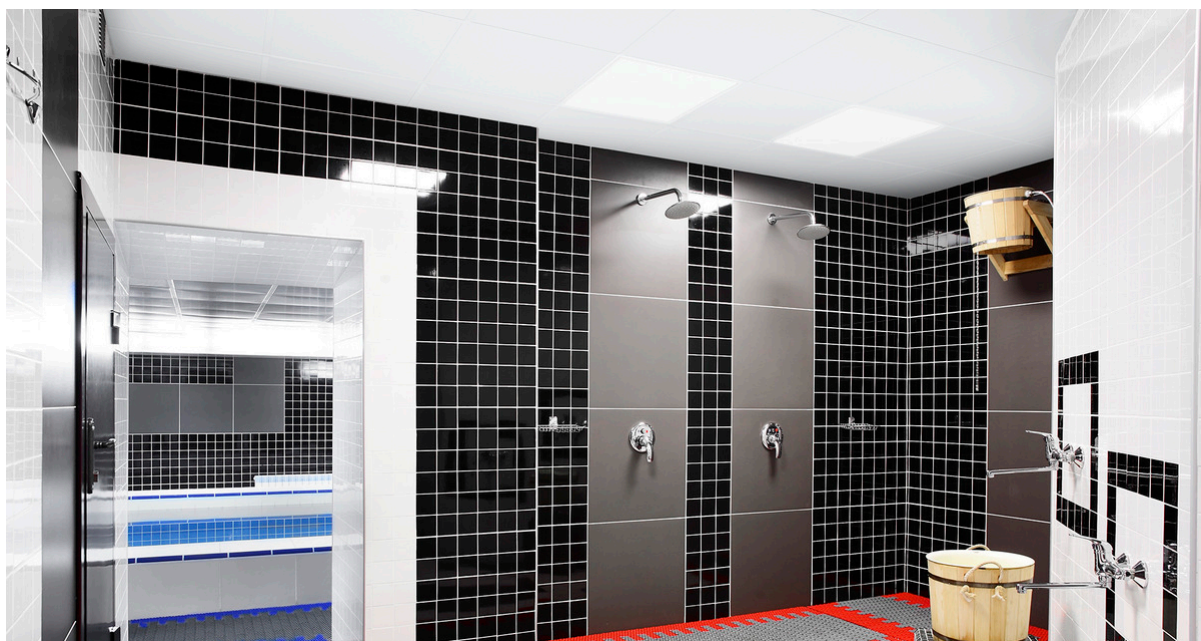

SÜSTEEMI INFO

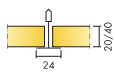

Mõõdud, mm	600x600	600x600	1200x600	1200x600
T24	•	•	•	•
Paksus (t)	20	40	20	40
Paigaldusjoonis	M246C4, M252C3	M246C4, M252C3	M246C4, M252C3	M246C4, M252C3

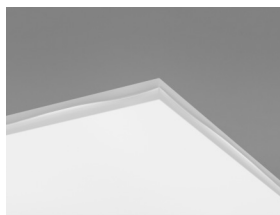

Hygiene Advance A plaat



Hygiene Advance A C4 sektioon koos Connect Hygiene klips 20



Hygiene Advance A C4 süsteem



Akustika

Hygiene Advance tehnilise plaadi helineelduvus on määritlemata (n.p.d.).

Heli neeldumine:

Testi tulemused vastavalt: EN ISO 354.

Klassifikatsioon vastavalt: EN ISO 11654, ja üksikute väärtuste hinnangud NRC ja SAA kohta (Noise Reduction Coefficient ja Sound Absorption Average), vastavalt: ASTM C 423.

α_p , Praktiline helineelduvustegur

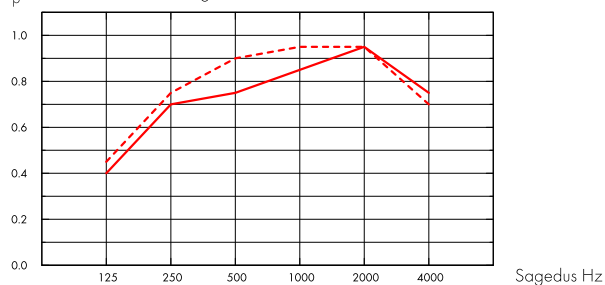

— Hygiene Advance A 20 mm, 200 mm o.d.s.

- - - Hygiene Advance A 40 mm, 200 mm o.d.s.

o.d.s = üldine süsteemi sügavus

t mm	o.d.s. mm	α_p , Praktiline helineelduvustegur						α_w	Helineeldumisklass
		125 Hz	250 Hz	500 Hz	1000 Hz	2000 Hz	4000 Hz		
20	200	0.40	0.70	0.75	0.85	0.95	0.75	0.85	B
40	200	0.45	0.75	0.90	0.95	0.95	0.70	0.90	A

t mm	o.d.s. mm	NRC	SAA
20	200	0.80	0.76
20	400	0.80	0.79
40	200	0.75	0.76
40	400	0.75	0.76



Siseõhu kvaliteet

Sertifikaat / Märkis	
Eurofins Indoor Air Comfort®	IAC Gold
Prantsusmaa LOÜ	A+
Soome M1	•





Süsiniku jalajälg

	kg CO ₂ equiv/m ²
Advance A 20mm	9,32
Advance A 40mm	16,23

Elutsükli etapid A1 kuni C4 EPD-st, vastavalt standardile ISO 14025 / EN 15804



Taaskasutus

Minimaalne tarbijajärgne taaskasutatud materjal	59%
Taaskasutus	Täielikult taaskasutatav



Tuleohutus

Riik	Tulestandard	Klass
Euroopa	EN 13501-1	A2-s1,d0

Toote klaasvillast põhiplaati on testitud ja klassifitseeritud kui mittepõlev vastavalt EN ISO 1182.



Niiskuskindlus

Klass D, suhteline õhuniiskus 97% ja 50°C, vastavalt standardile EN 13964:2014



Valguspeegeldus

White 141, lähim NSC värvinäidis S 1000-N, 73% valguspeegeldus. Tähelepanu: Väike erinevus läikes ja välimuses Hygiene Advance plaadi ja Hygiene Advance tehnilise plaadi vahel.



Puhastatavus

Standard/meetod	Frequency
Tolmu pühkimine	Igapäevane
Märgpuhastus	Igapäevane
Aurupuhastus	Igapäevane
Madalsurvepuhastus	Igapäevane
Kõrgsurvepuhastus	Igapäevane
Vesinikperoksiidi aur	•
UV-C, BIFMA HCF 8.1-2019	•



Kemikaalitaluvus/desinfektsioon

Kemikaal	Kontsentratsioon
Formalin	37%
Ammoniac	25%
Hydrogen peroxide	30%
Sulfuric acid	5%
Phosphoric acid	30%
Peracetic acid	15%
Hydrochloric acid	5%
Isopropanol	100%
Sodium hydroxide	5%
Sodium hypochlorite	5%

Tested according to ISO 2812-1 and classified according to ISO 4628-1 with excellent result for the following chemicals.



Hallituse- ja bakteriresistentsus

Standard/meetod	Klass
ISO 846 :2019 meetod C (bakteri jaoks)	0 (Mikroskoobi all ei ole kasvu)
ASTM D3273-16 (seente jaoks)	10 (0% kasv pinnal)



Puhasruum

	Standard/meetod	Klass
ISO 14644	Particle cleanliness class	ISO 3
NF S 90-351	Microbiological class	M1/area 4
NF S 90-351	Particle elimination kinetics	CP(0,5) 1



Õhu läbilaskvus

Advance 20 mm	Positiivne rõhk m ³ /(h x m ²)	Negatiivne rõhk m ³ /(h x m ²)	Positiivne rõhk L/s/m ²	Negatiivne rõhk L/s/m ²	Advance A 40 mm	Positiivne rõhk m ³ /(h x m ²)	Negatiivne rõhk m ³ /(h x m ²)	Positiivne rõhk L/s/m ²	Negatiivne rõhk L/s/m ²
10 (Pa)	13,1	12,5	3,6	3,5	10 (Pa)	4,2	4,4	1,2	1,2
20 (Pa)	20,9	17,9	5,8	5,0	20 (Pa)	6,1	6,3	1,7	1,7
30 (Pa)	27,5	22,0	7,6	6,1	30 (Pa)	7,7	7,7	2,1	2,1
40 (Pa)	33,4	25,5	9,3	7,1	40 (Pa)	9,1	8,9	2,5	2,5
50 (Pa) /Q50	38,8	28,6	10,8	8,0	50 (Pa) /Q50	10,3	10,0	2,9	2,8

Õhulekke kiirus mõõdetuna positiivsel vastaval negatiivsel ruumirõhul kuni 50 Pa (Q50) EN ISO 9972 :2015



Avatavus

Plaadid on avatavad. Minimaalne avamise kõrgus vastavalt paigaldusjoonisele. Plaadid on kinnitatud kasutades Connect Hygiene klipse, et tagada efektiivne puhastatavus. Klipsid on lae pealtpoolt lihtsalt eemaldadavad. Connect Demo klips 20 C4 kasutatakse lihtsustamaks pääsemist lae peale.



Paigaldus

Paigaldus vastavalt paigaldusjoonistele, -juhenditele ja Drawing Aid järgi. Lõigatud plaadiservad viimistleda Connect Hygiene Advance teibiga. Sisselõiked viimistleda sobiva viimistlusvahendiga.



Süsteemi kaal

Ripplae kaal (koos liistusüsteemiga) on ca 3 kg/m² 20 mm paksusel plaadil ja 4,5 kg/m² 40 mm paksusel plaadil.



Mehaanilised omadused

Infot Max punktikoormuse ja Min koormuskandevõime kohta vaata tabelist; tehnilisi tingimusi ja mehaanilisi omadusi vaata www.ecophon.ee.



CE

Ecophoni laesüsteemid on CE-märgisega vastavalt Euroopa standardile EN13964:2014. CE-märgisega ehitustooted on hõlmatud toimumisdeklaratsiooniga (Declarations of Performance - DOP), mis võimaldab klientidel ja kasutajatel kergesti võrrelda Euroopa turul olevaid tooteid.

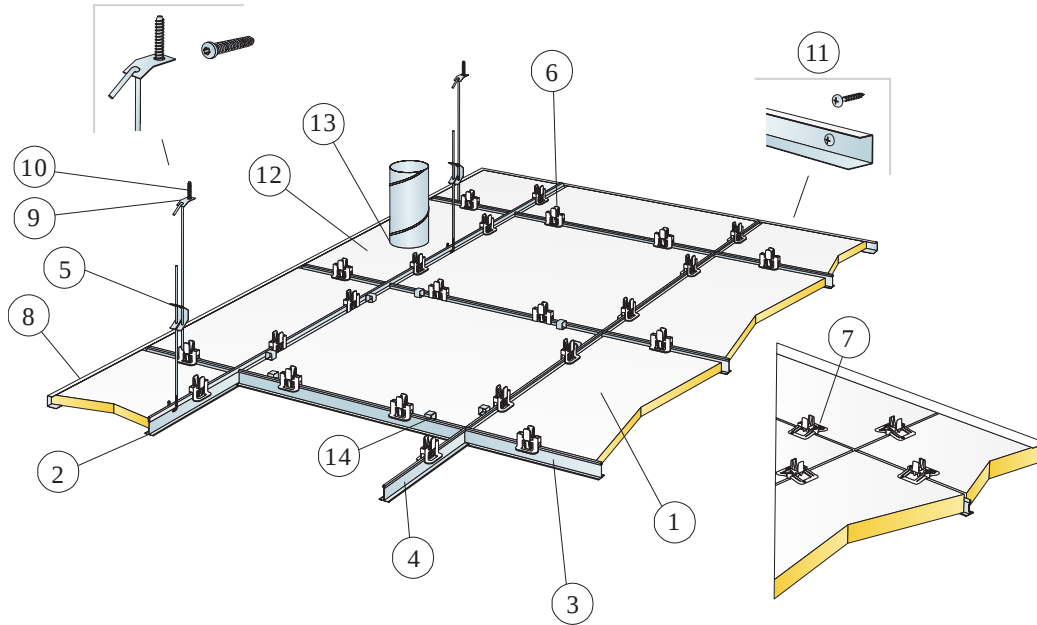

© Saint-Gobain Ecophon AB

KOGUSTE SPETSIFIKATSIOON (VALEMI JÄRGI)

	Mõõdud, mm		
	600x600	1200x600	
1	Hygiene Advance A	2,8/m ²	1,4/m ²
2	Connect T24 kandur C4, c1200	0,9m/m ²	0,9m/m ²
3	Connect T24 vahelist C4, L=1200, c600	1,7m/m ²	1,7m/m ²
4	Connect T24 vahelist C4, L=600	0,9m/m ²	-
5	Connect reguleeritav riputi C4, c1200, (max kaugus seinast 600 mm)	0,7/m ²	0,7/m ²
6	Connect Hygiene klips 20	11/m ²	7/m ²
7	Connect Hygiene klips 40 C4	11/m ²	7/m ²
8	Connect U-liist C4, kinnitus c300	vastavalt vajadusele	
9	Connect kinnitusplaat C4	0,7/m ²	0,7/m ²
10	Connect Anchor kruvi C4	0,7/m ²	0,7/m ²
11	Connect Paigalduskruvi C4	3,4/m U-liist C4	
12	Ecophon Hygiene Advance tehniline plaat	vastavalt vajadusele	
13	Hermeetik (ei kuulu Ecophoni tootevalikusse)	vastavalt vajadusele	
14	Connect Demo klips 20 C4, (kuhu ligipääs on vajalik)	vastavalt vajadusele	
15	Connect Hygiene Advance teip	vastavalt vajadusele	
Δ Min. süsteemi paigalduskõrgus: 150 mm			-
δ Min. avamise kõrgus: 150 mm			-

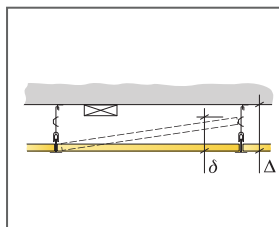

Vaata koguste spetsifikatsiooni

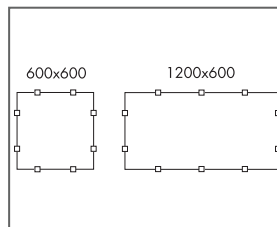

Klipside paigutus

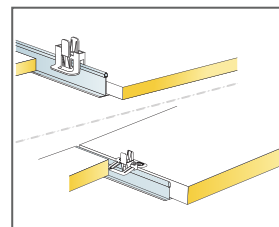

Klips platide paigal hoidmiseks. 20/40 mm platidele.

Mõõdud, mm	Max punktkoormus [N]	Max punktkoormuse kestvus [N]
600x600x20	40	160
600x600x40	40	160
1200x600x20	40	160
1200x600x40	40	160

Punktkoormus/Punktkoormuse kestvus platidele.

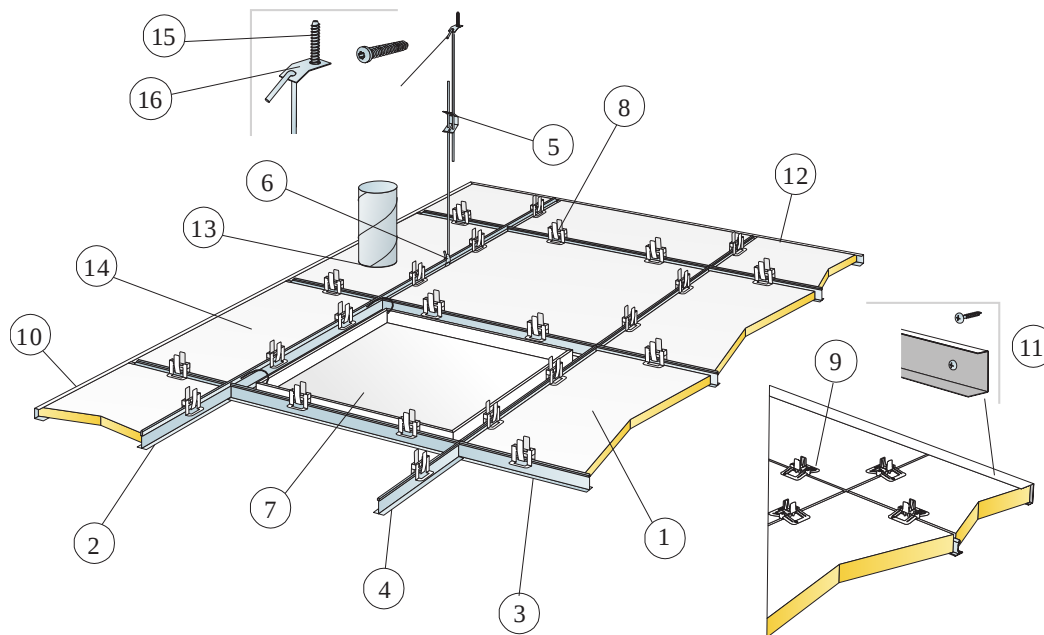

© Saint-Gobain Ecophon AB

KOGUSTE SPETSIFIKATSIOON (VALEMI JÄRGI)

		Mõõdud, mm	
		600x600	1200x600
1	Hygiene Advance A	2,8/m ²	1,4/m ²
2	Connect T24 kandur C3, paigaldus 1200 mm tagant	0,9m/m ²	0,9m/m ²
3	Connect T24 vahelist C3, L=1200 mm, paigaldus 600 mm tagant	1,7m/m ²	1,7m/m ²
4	Connect T24 vahelist C3, L=600 mm	0,9m/m ²	-
5	Connect reguleeritav riputi C3, c1200 (max kaugus seinast 600 mm)	0,7/m ²	0,7/m ²
6	Connect riputi klips (mitte kasutada ujula keskkonnas)	0,7/m ²	0,7/m ²
7	Connect hooldusluuk C3	vastavalt vajadusele	
8	Connect Hygiene klips 20	11/m ²	7/m ²
9	Connect Hygiene klips 40	11/m ²	7/m ²
10	Connect U-liist C3, kinnitus c300 (20 mm plaadile)	vastavalt vajadusele	
11	Connect U-liist C3, kinnitus c300 (40 mm plaadile)	vastavalt vajadusele	
12	Connect Hygiene Advance teip	vastavalt vajadusele	
13	Hermeetik (ei kuulu Ecophoni tootevalikusse)	vastavalt vajadusele	
14	Ecophon Hygiene Advance tehniline plaat	vastavalt vajadusele	
15	Connect Anchor kruvi C4	0,7/m ²	0,7/m ²
16	Connect kinnitusplaat C4	0,7/m ²	0,7/m ²

Δ Min. süsteemi paigalduskõrgus: 150 mm

δ Min. avamise kõrgus 20 mm: 150 mm

Mõõdud, mm	Max	Max
	punktkoormus [N]	punktkoormuse kestvus [N]
600x600x20	40	160
600x600x40	40	160
1200x600x20	40	160
1200x600x40	40	160

Vaata koguste spetsifikatsiooni

Klipside paigutus

Klipsid hoiavad plaate paigal

Punktkoormus/Punktkoormuse kestvus

Ecophon Hygiene Advance™ Baffle

Ecophon Hygiene Advance™ Baffle A on vertikaalne ripp-paneel, mis talub igapäevast põhjalikku puhastamist ja desinfitseerimist tugevate kemikaalidega. Sobib ka kõige nõudlikumasse tingimustesse, sealhulgas õhus levivate rasva- ja mustuseosakeste puhul.

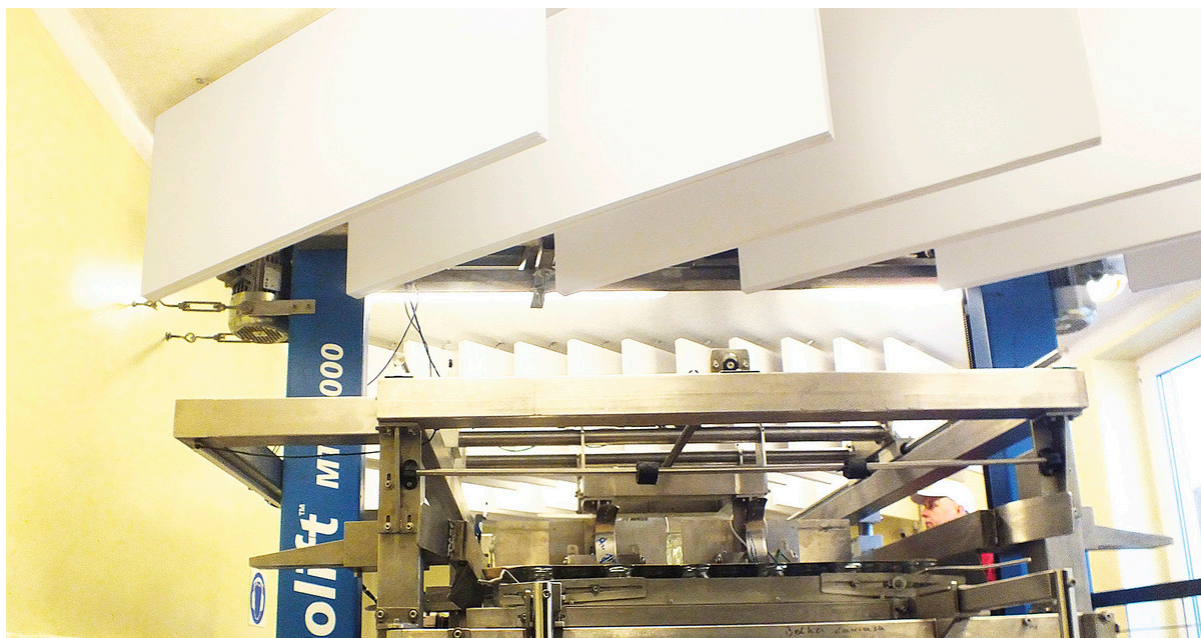

Kępczyn Małonezy, Poland

SÜSTEEMI INFO



Möödud, mm	1200x600
T24	•
Paksus (t)	40
Paigaldusjoonis	M259, M260

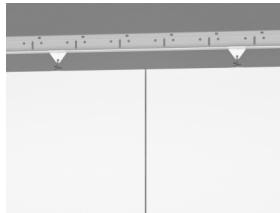

Hygiene Advance Baffle C3 reas

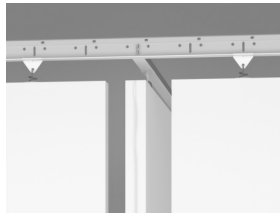

Hygiene Advance Baffle C3 nelinurgas

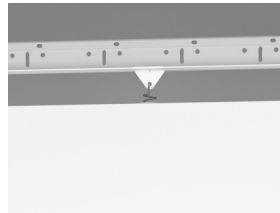

Hygiene Advance Baffle C3 koos
Connect Baffle klipsiga



Hygiene Advance Baffle

Akustika



Heli neeldumine:

Testitulemused vastavalt: EN ISO 354:2003 MÄRKUS: Näidatud tulemused ei ole võrreldavad standardi vanema versiooni tulemustega erinevuste tõttu testimise meetodis. Klassifikatsioon vastavalt: EN ISO 11654, ja üksikute väärtuste hinnangud NRC ja SAA kohta (Noise Reduction Coefficient ja Sound Absorption Average), vastavalt: ASTM C 423.

α_p , Praktiline helineelduvustegur

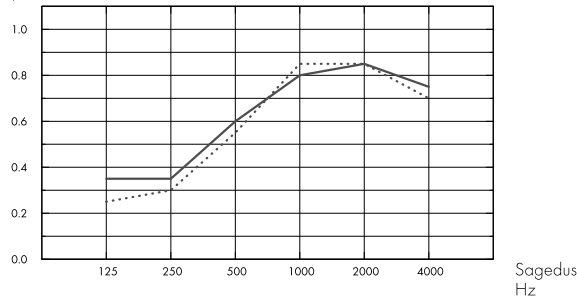

... Advance Baffle reas, c600 mm, ~1,4 Baffle't ruutmeetri kohta, 600 mm o.d.s.

– Advance Baffle riskülikutena, ~1,3 Baffle't ruutmeetri kohta, 600 mm o.d.s.

o.d.s = üldine süsteemi sügavus

	t mm	o.d.s. mm	α_p , Praktiline helineelduvustegur						α_w	Helineeldumisklass
			125 Hz	250 Hz	500 Hz	1000 Hz	2000 Hz	4000 Hz		
in rows	40	600	0.25	0.30	0.55	0.85	0.85	0.70	0.55	D
in rectangles	40	600	0.35	0.35	0.60	0.80	0.85	0.75	0.60	C

	t mm	o.d.s. mm	NRC	SAA
in rows	40	600	1.00	1.00
in rectangles	40	600	1.00	1.00

Siseõhu kvaliteet



Sertifikaat / Märgis

Eurofins Indoor Air Comfort®

IAC Gold

Prantsusmaa LOÜ

A+

Soome M1

•



Süsiniku jalajälg



kg CO₂ equiv/m²

Advance Baffle

16,23

Elutsükli etapid A1 kuni C4 EPD-st, vastavalt standardile ISO 14025 / EN 15804



Taaskasutus

Minimaalne tarbijajõrgne taaskasutatud materjal	64%
Taaskasutus	Täielikult taaskasutatav



Tuleohutus

Riik	Tulestandard	Klass
Euroopa	EN 13501-1	A2-s1,d0

Toote klaasvillast põhiplaati on testitud ja klassifitseeritud kui mittepõlev vastavalt EN ISO 1182.



Niiskuskindlus

Testitud C-klassi puhul, suhteline õhuniiskus 95% ja 30°C, vastavalt EN 13964:2014



Valguspeegeldus

White 141, lähim NSC värvinäidis S 1000-N, 73% valguspeegeldus.



Puhastatavus

Standard/meetod	Frequency
Tolmu pühkimine	Igapäevane
Märgpuhastus	Igapäevane
Aurupuhastus	Igapäevane
Madalsurvepuhastus	Igapäevane
Kõrgsurvepuhastus	Igapäevane
Vesinikperoksiidi aur	•
UV-C, BIFMA HCF 8.1-2019	•



Kemikaalitaluvus/desinfektsioon

Kemikaal	Kontsentratsioon
Formalin	37%
Ammoniac	25%
Hydrogen peroxide	30%
Sulfuric acid	5%
Phosphoric acid	30%
Peracetic acid	15%
Hydrochloric acid	5%
Isopropanol	100%
Sodium hydroxide	5%
Sodium hypochlorite	5%

Tested according to ISO 2812-1 and classified according to ISO 4628-1 with excellent result for the following chemicals.



Hallituse- ja bakteriresistentsus

Standard/meetod	Klass
ISO 846 :2019 meetod C (bakteri jaoks)	0 (Mikroskoobi all ei ole kasvu)
ASTM D3273-16 (seente jaoks)	10 (0% kasv pinnal)



Puhasruum

	Standard/meetod	Klass
ISO 14644	Particle cleanliness class	ISO 3
NF S 90-351	Microbiological class	M1/area 4
NF S 90-351	Particle elimination kinetics	CP(0,5) 1



Avatavus

Plaadid on avatavad.



Paigaldus

Paigaldus vastavalt paigaldusjoonistele, -juhenditele ja Drawing Aid järgi. Lõigatud plaadiservad viimistleda Connect Hygiene Advance teibiga. Sisselõiked viimistleda sobiva viimistlusvahendiga.



Süsteemi kaal

Süsteemi kaal (koos liistusüsteemiga) on ca 4 kg/m².



Mehaanilised omadused

Infot Max punktkoormuse ja Min koormuskandevõime kohta vaata tabelist; tehnilisi tingimusi ja mehaanilisi omadusi vaata www.ecophon.ee.



CE

Ecophoni laesüsteemid on CE-märgisega vastavalt Euroopa standardile EN13964:2014. CE-märgisega ehitustooted on hõlmatud toimivusdeklaratsiooniga (Declarations of Performance - DOP), mis võimaldab klientidel ja kasutajatel kergesti võrrelda Euroopa turul olevaid tooteid.

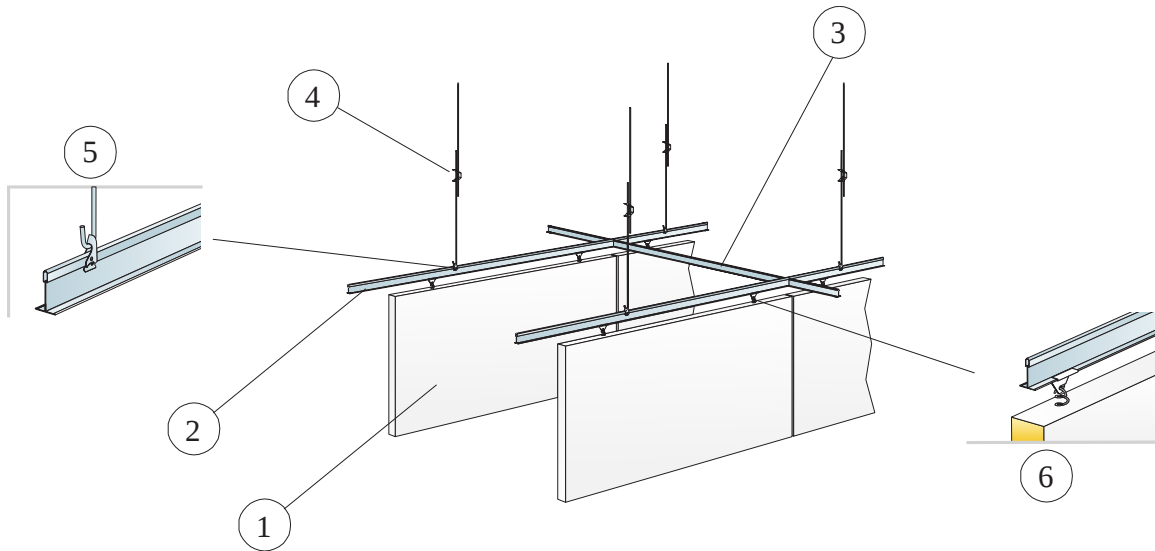

© Saint-Gobain Ecophon AB

KOGUSTE SPETSIFIKATSIOON (VALEMI JÄRGI)

		Mõõdud, mm
		1200x600
1	Hygiene Advance Baffle	1,4/m ²
2	Connect T24 kandur C3, paigaldus 600 mm tagant	1,7m/m ²
3	Connect T24 vahelist C3, L=600 mm, paigaldus 1800 mm tagant	0,6m/m ²
4	Connect reguleeritav riputi C3 c1200	1,4/m ²
5	Connect riputi klips	1,4/m ²
6	Connect Baffle klips C3	2,8/m ²

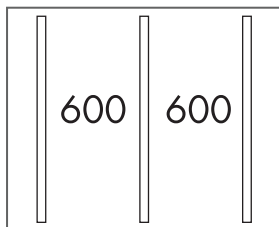

Paigaldus ridadena

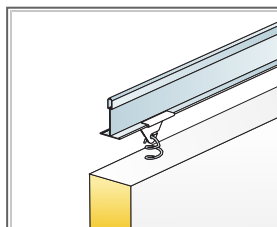

Riputusdetail

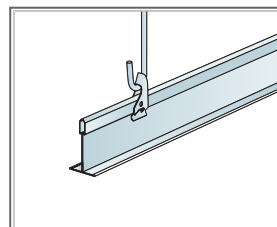

Riputus Connect reguleeritava riputi ja Connect klipsiga

Mõõdud, mm	Max punktkoormus [N]	Max punktkoormuse kestvus [N]
1200x600x40	0	160

Punktkoormus/Punktkoormuse kestvus

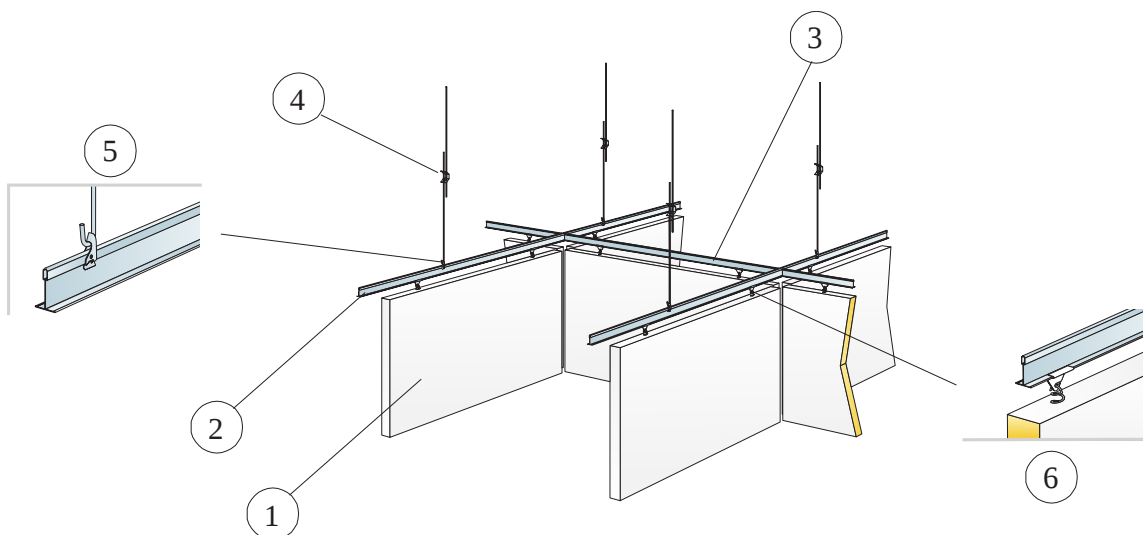

© Saint-Gobain Ecophon AB

KOGUSTE SPETSIFIKATSIOON (VALEMI JÄRGI)

		Mõõdud, mm
		1200x600
1	Hygiene Advance Baffle	1,3/m ²
2	Connect T24 kandur C3, paigaldus 1250 mm tagant	0,8m/m ²
3	Connect T24 vaheliist C3, L=1250 mm, paigaldus 1300 mm tagant	0,8m/m ²
4	Connect reguleeritav riputi C3	0,7/m ²
5	Connect riputi klips	0,7/m ²
6	Connect Baffle klips C3	2,5/m ²

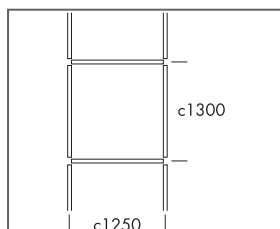

Paigaldus ruutudena

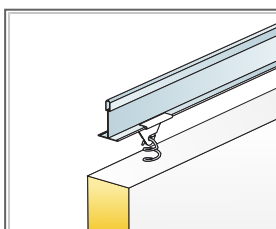

Riputusdetail

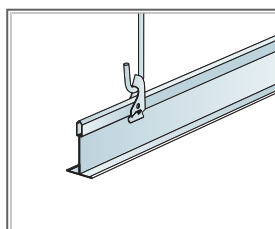

Riputus Connect reguleeritava riputi ja Connect klipsiga

Mõõdud, mm	Max punktkoormus [N]	Max punktkoormuse kestvus [N]
1200x600x40	0	160

Punktkoormus/Punktkoormuse kestvus

Ecophon Hygiene Advance™ Wall

Ecophon Hygiene Advance™ Wall A on seinapaneel, mis talub igapäevast põhjalikku puhastamist ja desinfitseerimist tugevate kemikaalidega. Sobib ka kõige nõudlikumasse tingimustesse, sealhulgas õhus levivate rasva- ja mustuseosakeste puhul.



SÜSTEEMI INFO

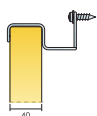

Mõõdud, mm	1200x600
Spetsiaalkinnitus	•
Paksus (t)	40
Paigaldusjoonis	M258

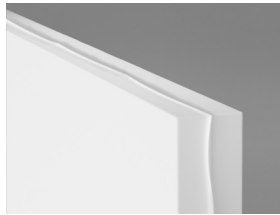

Hygiene Advance Wall



Connect seinakinnitus C3

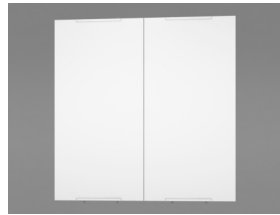

Hygiene Advance Wall C3 süsteem

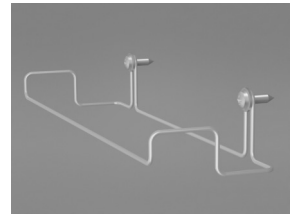

Connect seinakinnitus C3

Akustika



Heli neeldumine:

Testitulemused vastavalt: EN ISO 354. Klassifikatsioon vastavalt: EN ISO 11654.

α_p , Praktiline helineelduvustegur

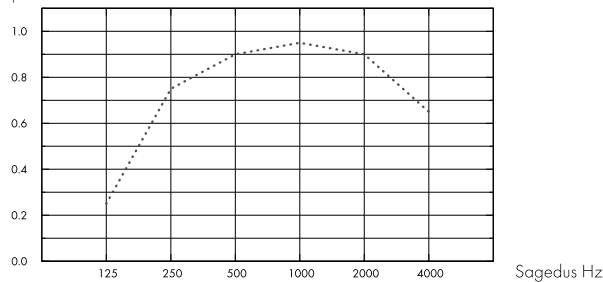

... Hygiene Advance Wall, 80 mm o.d.s.

o.d.s = üldine süsteemi sügavus

t mm	o.d.s. mm	α_p , Praktiline helineelduvustegur						α_{wv}	Helineeldumisklass
		125 Hz	250 Hz	500 Hz	1000 Hz	2000 Hz	4000 Hz		
40	80	0.25	0.75	0.90	0.95	0.90	0.65	0.85	B

Siseõhu kvaliteet



Sertifikaat / Märkis

Eurofins Indoor Air Comfort®

IAC Gold

Prantsusmaa LOÜ

A+

Soome M1

•



Süsiniku jalajälg



kg CO₂ equiv/m²

Advance Wall

16,23

Elutsükli etapid A1 kuni C4 EPD-st, vastavalt standardile ISO 14025 / EN 15804

Taaskasutus



Minimaalne tarbijajärgne taaskasutatud materjal

64%

Taaskasutus

Täielikult taaskasutatav

Tuleohutus



Riik
Euroopa

Tulestandard
EN 13501-1

Klass
A2-s1,d0

Toote klaasvillast põhiplaati on testitud ja klassifitseeritud kui mittepõlev vastavalt EN ISO 1182.



Niiskuskindlus

Testitud C-klassi puhul, suhteline õhuniiskus 95% ja 30°C, vastavalt EN 13964:2014



Valguspegeldus

White 141, lähim NSC värvinäidis S 1000-N, 73% valguspegeldus.



Puhastatavus

Standard/meetod	Frequency
Tolmu pühkimine	Igapäevane
Märgpuhastus	Igapäevane
Aurupuhastus	Igapäevane
Madalsurvepuhastus	Igapäevane
Kõrgsurvepuhastus	Igapäevane
Vesinikperoksiidi aur	•
UV-C, BIFMA HCF 8.1-2019	•



Kemikaalitaluvus/desinfektsioon

Kemikaal	Kontsentratsioon
Formalin	37%
Ammoniac	25%
Hydrogen peroxide	30%
Sulfuric acid	5%
Phosphoric acid	30%
Peracetic acid	15%
Hydrochloric acid	5%
Isopropanol	100%
Sodium hydroxide	5%
Sodium hypochlorite	5%

Tested according to ISO 2812-1 and classified according to ISO 4628-1 with excellent result for the following chemicals.



Hallituse- ja bakteriresistentsus

Standard/meetod	Klass
ISO 846 :2019 meetod C (bakteri jaoks)	0 (Mikroskoobi all ei ole kasvu)
ASTM D3273-16 (seente jaoks)	10 (0% kasv pinnal)



Puhasruum

	Standard/meetod	Klass
ISO 14644	Particle cleanliness class	ISO 3
NF S 90-351	Microbiological class	M1/area 4
NF S 90-351	Particle elimination kinetics	CP(0,5) 1



Avatavus

Plaadid on avatavad.



Paigaldus

Paigaldus vastavalt paigaldusjoonistele, -juhenditele ja Drawing Aid järgi. Infot minimaalse süsteemi paigalduskõrguse kohta vaata koguste spetsifikatsioonist.



Süsteemi kaal

Süsteemi kaal (koos profiilsüsteemiga) on ca 3 kg/tk.



Mehaanilised omadused

Infot Max punktkoormuse ja Min koormuskandevõime kohta vaata tabelist; tehnilisi tingimusi ja mehaanilisi omadusi vaata www.ecophon.ee.



CE

Ecophoni laesüsteemid on CE-märgisega vastavalt Euroopa standardile EN13964:2014. CE-märgisega ehitustooted on hõlmatud toimivusdeklaratsiooniga (Declarations of Performance - DOP), mis võimaldab klientidel ja kasutajatel kergesti võrrelda Euroopa turul olevaid tooteid.

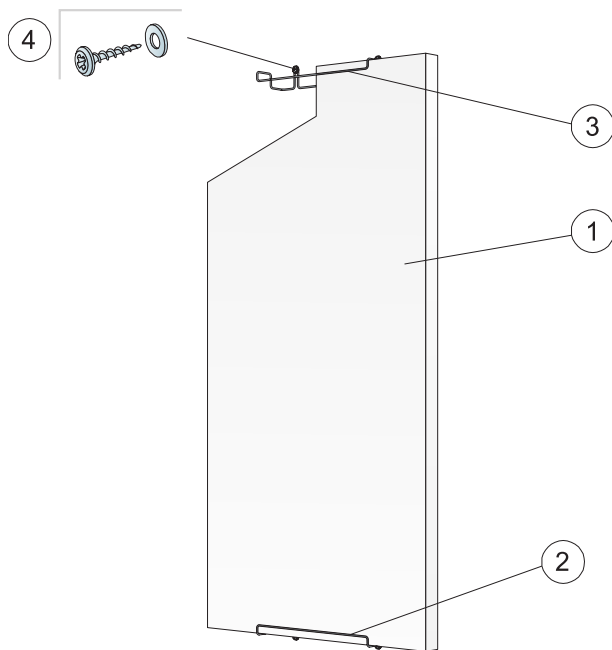

© Saint-Gobain Ecophon AB

KOGUSTE SPETSIFIKATSIOON (VALEMI JÄRGI)

		Mõõdud, mm
		1200x600
1	Hygiene Advance Wall	1,4/m ²
2	Connect seinakinnitus C3, vertikaalseks paigalduseks	2/paneeli kohta
3	Connect seinakinnitus C3, horisontaalseks paigalduseks	4/paneeli kohta
4	Seinakruvi, A2 materjal (ei kuulu Ecophoni tootevalikusse)	2/seinakinnitus
Δ Min. süsteemi paigalduskõrgus: 90 mm		-

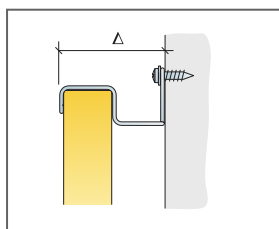

Vaata koguste spetsifikatsiooni

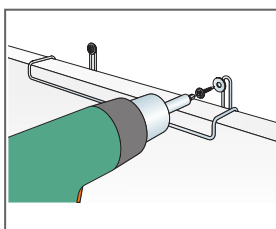

Paigaldus roostevabast terasest (A2) seinakruvidega

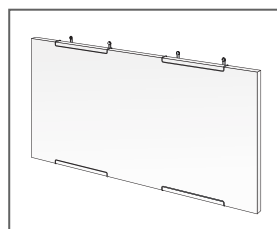

Advance Wall C3 horisontaalne paigaldus

Mõõdud, mm	Max punktkoormus [N]	Max punktkoormuse kestvus [N]
1200x600x40	0	-

Punktkoormus/Punktkoormuse kestvus