

# Ecophon Gedina™ A

Ecophon Gedina™ A has an exposed grid system with each tile individually demountable for easy access to above soffit. Ecophon Gedina™ A is made for applications which require an easy install, suspended ceiling and meet standard functional demands.



Ardree Special School, Omagh, United Kingdom

## SYSTEM RANGE

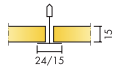

Size, mm	600x600	1200x600	1200x1200
Connect T15	•	•	•
Connect T24	•	•	•
Thickness (THK)	15	15	15
Inst. Diagr.	M118, M237	M118	M118

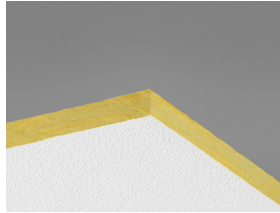

Gedina A tile

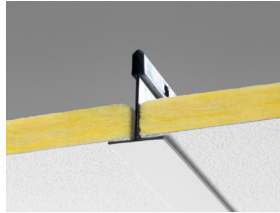

Section of Gedina A system



Gedina A system

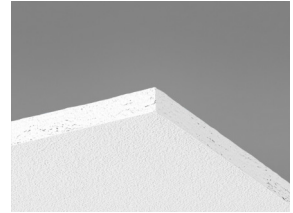

Gedina A tile

## Acoustic



### Sound Absorption:

Test results according to EN ISO 354. Classification according to EN ISO 11654.

$\alpha_p$ , Practical sound absorption coefficient

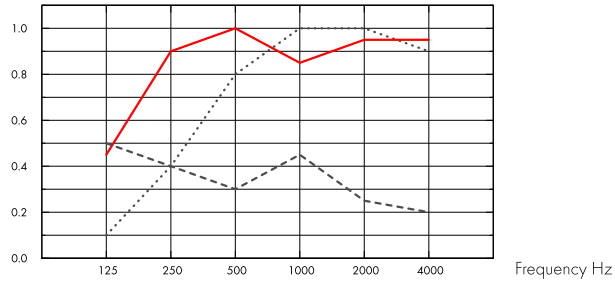

.... Gedina A 15 mm, 50 mm o.d.s.

— Gedina A 15 mm, 200 mm o.d.s.

--- Gedina A/gamma 15 mm, 200 mm o.d.s.

o.d.s = overall depth of system

	THK mm	o.d.s. mm	$\alpha_p$ , Practical sound absorption coefficient						$\alpha_w$	Sound absorption class
			125 Hz	250 Hz	500 Hz	1000 Hz	2000 Hz	4000 Hz		
-	15	50	0.10	0.40	0.80	1.00	1.00	0.90	0.70	C
-	15	200	0.45	0.90	1.00	0.85	0.95	0.95	0.95	A
gamma	15	200	0.50	0.40	0.30	0.45	0.25	0.20	0.30	D

	THK mm	o.d.s. mm	NRC	SAA
-	15	50	0.80	0.80
-	15	400	0.85	0.86

THK mm	AC(1.5) Articulation Class, ASTM E1111, ASTM E1110	$D_{nfw}$ Weighted normalized flanking level difference, ISO 10848-2	CAC dB Ceiling Attenuation Class, ASTM 1414, ASTM E413
15	190	19	19

## Indoor Air Quality



Certificate / Label

Eurofins Indoor Air Comfort®

IAC Gold

French VOC

A+





## Carbon footprint

kg CO <sub>2</sub> equiv/m <sup>2</sup>	
Gedina A	2,06

Life-cycle stages A1 to C4 from EPD, in conformity with ISO 14025 / EN 15804



## Circularity

Minimum post-consumer recycled content	46%
Recyclability	Fully recyclable



## Fire safety

Country	Class	
Europe	EN 13501-1	A2-s1,d0

The glass wool core of the tiles is tested and classified as non-combustible according to EN ISO 1182.



## Humidity Resistance

Classification
Class C, RH 95% and 30°C



## Visual appearance

White 500, nearest NCS colour sample S 0500-N, 84% light reflectance.



## Cleanability

Daily dusting and vacuum cleaning. Weekly wet wiping.



## Accessibility

The tiles are easily demountable. Minimum demounting depth according to installation diagrams.



## Installation

Installed according to installation diagrams, installation guides and drawing aid. For information regarding minimum overall depth of system see quantity specification.



## System weight

	kg/m <sup>2</sup>
Gedina A	1,3
Gedina A + Connect grid system	2,3
Gedina A/Gamma	2,7
Gedina A/Gamma + Connect grid system	1,7

Weight information is indicative and subject to variation.



## Mechanical properties

See table about Max live load and Min load bearing capacity and Functional demands, Mechanical properties at [www.ecophon.com](http://www.ecophon.com).



## CE

---

Ecophon ceiling systems are CE marked according to the European harmonized standard EN13964:2014. CE marked construction products are covered by a Declaration of Performance (DOP) which enables customers and users to easily compare performance of products available on the European market.

## INSTALLATION DIAGRAM (M118) FOR ECOPHON GEDINA A

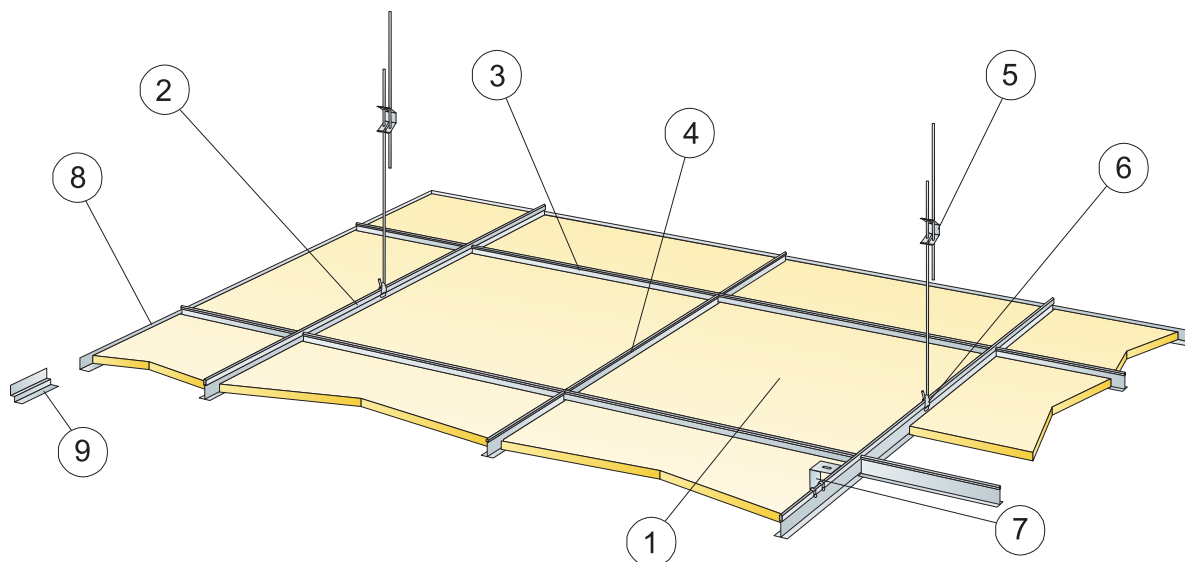

© Ecophon Group

### QUANTITY SPECIFICATION (EXCL. WASTAGE)

	Size, mm		
	600x600	1200x600	1200x1200
1 Gedina A	2,8/m <sup>2</sup>	1,4/m <sup>2</sup>	0,7/m <sup>2</sup>
2 Connect T24 or T15 Main runner, installed at 1200 mm centres (max. distance from wall 600 mm, can be extended up to 1200 mm if no live load between Main runner and wall).	0,9m/m <sup>2</sup>	0,9m/m <sup>2</sup>	0,9m/m <sup>2</sup>
3 Connect T24 or T15 Cross tee, L=1200 mm, installed at 600 mm centres	1,7m/m <sup>2</sup>	1,7m/m <sup>2</sup>	0,9m/m <sup>2</sup>
4 Connect T24 or T15 Cross tee, L=600 mm	0,9m/m <sup>2</sup>	-	-
5 Connect Adjustable hanger, installed at 1200 mm centres (max. distance from wall 600 mm)	0,7/m <sup>2</sup>	0,7/m <sup>2</sup>	0,7/m <sup>2</sup>
6 Connect Hanger Clip (not to be used in swimming hall environments)	0,7/m <sup>2</sup>	0,7/m <sup>2</sup>	0,7/m <sup>2</sup>
7 For direct installation: Connect Direct Bracket, installed at 1200 mm centres	0,7/m <sup>2</sup>	0,7/m <sup>2</sup>	0,7/m <sup>2</sup>
8 Connect Angle Trim, fixed at 300 mm centres	as required	as required	as required
9 Connect Shadow-line Trim, fixed at 300 mm centres	as required	as required	as required
Δ Min. overall depth of system, with adjustable hanger: 100 mm, with direct bracket: 50 mm	-	-	-
δ Min. demounting depth: 120 mm (130 mm with 1200x1200)	-	-	-
For luminaire integration in panels use Connect Bridging	-	-	-

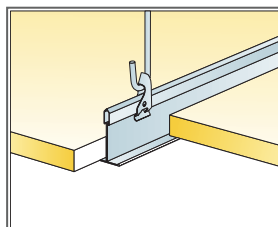
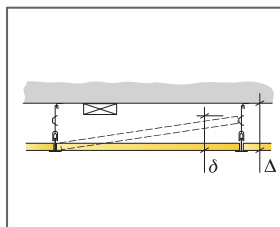

Suspension with adjustable hanger and clip

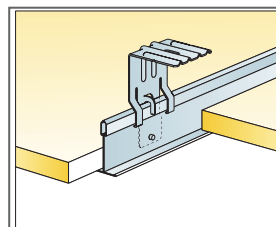

Suspension with direct bracket

Size, mm	Max live load [N]	Min load bearing capacity [N]
600x600x15	50	160
1200x600x15	50	160
1200x1200x15	50	160

Live load/load bearing capacity

## INSTALLATION DIAGRAM (M237) FOR ECOPHON GEDINA A, CONNECT T24 MAIN RUNNER INSTALLED AT 1800 MM CENTRES

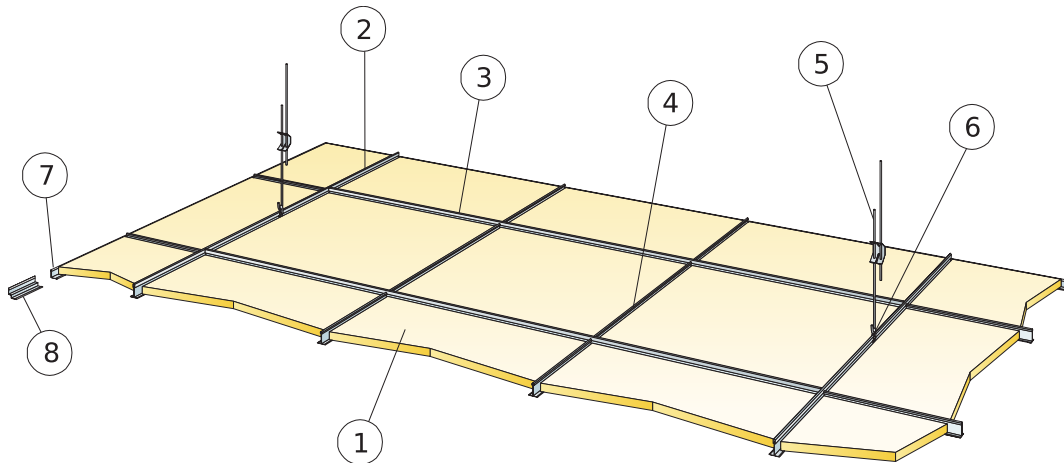

© Ecophon Group

### QUANTITY SPECIFICATION (EXCL. WASTAGE)

	Size, mm
	<b>600x600</b>
1 Gedina A	2,8/m <sup>2</sup>
2 Connect T24 Main runner, installed at 1800 mm centres (max. distance from wall 600 mm, can be extended up to 1200 mm if no live load between Main runner and wall).	0,56/m <sup>2</sup>
3 Connect T24 Cross tee, L=1800 mm	1,7m/m <sup>2</sup>
4 Connect T24 Cross tee, L=600 mm	1,1m/m <sup>2</sup>
5 Connect Adjustable hanger, installed at 1200 mm centres (max. distance from wall 600 mm)	0,46/m <sup>2</sup>
6 Connect Hanger clip	0,46/m <sup>2</sup>
7 Connect Angle trim, fixed at 300 mm centres	as required
8 Alt. Connect Shadow-line Trim, fixed c300	as required
δ Min. demounting depth: 120 mm	-
Δ Min. overall depth of system, with adjustable hanger: 100 mm, with direct bracket: 50 mm	-

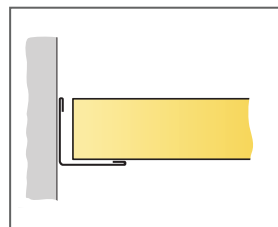
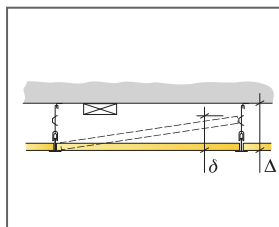

Straight cut, panel resting on wall trim

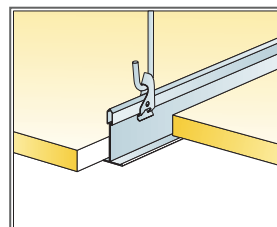

Suspension with adjustable hanger and clip

Size, mm	Max live load [N]	Min load bearing capacity [N]
600x600x15	20	160

Live load/load bearing capacity

# Ecophon Gedina™ E

Ecophon Gedina™ E has a recessed visible grid and a tegular edge design, creating a ceiling with a shadow effect that accentuates each tile and partially conceals the grid system. For applications which require an easy install, suspended ceiling and meet standard functional demands.



## SYSTEM RANGE

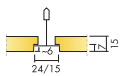

Size, mm	600x600	1200x600	1200x1200
Connect T15	•	•	
Connect T24	•	•	•
Thickness (THK)	15	15	15
Inst. Diagr.	M121, M270, M401	M121, M401	M121



Gedina E tile

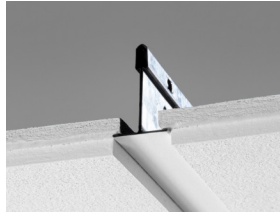

Section of Gedina E system



Gedina E system

## Acoustic



### Sound Absorption:

Test results according to EN ISO 354. Classification according to EN ISO 11654, and the single value ratings for Noise Reduction Coefficient, NRC and Sound Absorption Average, SAA according to ASTM C 423.

$\alpha_p$ , Practical sound absorption coefficient

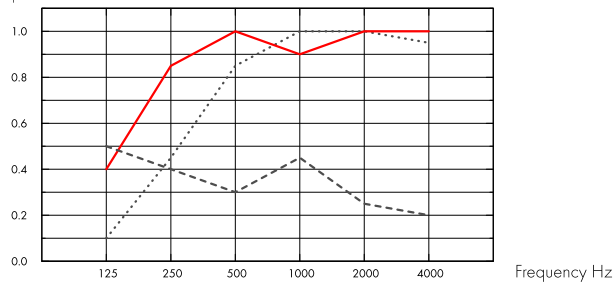

- ..... Gedina E 15 mm, 60 mm o.d.s.
  - Gedina E 15 mm, 200 mm o.d.s.
  - Gedina E/gamma 15 mm, 200 mm o.d.s.
- o.d.s = overall depth of system

	THK mm	o.d.s. mm	$\alpha_p$ , Practical sound absorption coefficient						$\alpha_w$	Sound absorption class
			125 Hz	250 Hz	500 Hz	1000 Hz	2000 Hz	4000 Hz		
-	15	60	0.10	0.45	0.85	1.00	1.00	0.95	0.75	C
-	15	200	0.40	0.85	1.00	0.90	1.00	1.00	1.00	A
gamma	15	200	0.50	0.40	0.30	0.45	0.25	0.20	0.30	D

	THK mm	o.d.s. mm	NRC	SAA
-	15	60	0.85	0.86
-	15	400	0.85	0.83

THK mm	AC(1.5) Articulation Class, ASTM E1111, ASTM E1110	$D_{nfw}$ Weighted normalized flanking level difference, ISO 10848-2	CAC dB Ceiling Attenuation Class, ASTM 1414, ASTM E413
15	190	19	19

## Indoor Air Quality



Certificate / Label

Eurofins Indoor Air Comfort®

IAC Gold

French VOC

A+







### Carbon footprint

kg CO <sub>2</sub> equiv/m <sup>2</sup>		Life-cycle stages A1 to C4 from EPD, in conformity with ISO 14025 / EN 15804
Gedina E	2,62	



### Circularity

Minimum post-consumer recycled content	44%
Recyclability	Fully recyclable



### Fire safety

Country	Class		The glass wool core of the tiles is tested and classified as non-combustible according to EN ISO 1182.
Europe	EN 13501-1	A2-s1,d0	



### Humidity Resistance

Class C, relative humidity 95% and 30°C, according to EN 13964:2014



### Humidity Resistance

Class A, relative humidity 70% and 25°C, according to EN 13964:2014



### Visual appearance

White 500, nearest NCS colour sample S 0500-N, 84% light reflectance.



### Cleanability

Daily dusting and vacuum cleaning. Weekly wet wiping.



### Accessibility

The tiles are easily demountable. Minimum demounting depth according to installation diagrams.



### Installation

Installed according to installation diagrams, installation guides and drawing aid. For information regarding minimum overall depth of system see quantity specification.



### System weight

	kg/m <sup>2</sup>	Weight information is indicative and subject to variation.
Gedina E	1,3	
Gedina E + Connect grid system	2,3	
Gedina E/Gamma	1,7	
Gedina E/Gamma + Connect grid system	2,7	



## **Mechanical properties**

---

See table about Max live load and Min load bearing capacity and Functional demands, Mechanical properties at [www.ecophon.com](http://www.ecophon.com).



## **CE**

---

Ecophon ceiling systems are CE marked according to the European harmonized standard EN 13964:2014. CE marked construction products are covered by a Declaration of Performance (DOP) which enables customers and users to easily compare performance of products available on the European market.

## INSTALLATION DIAGRAM (M121) FOR ECOPHON GEDINA E T24

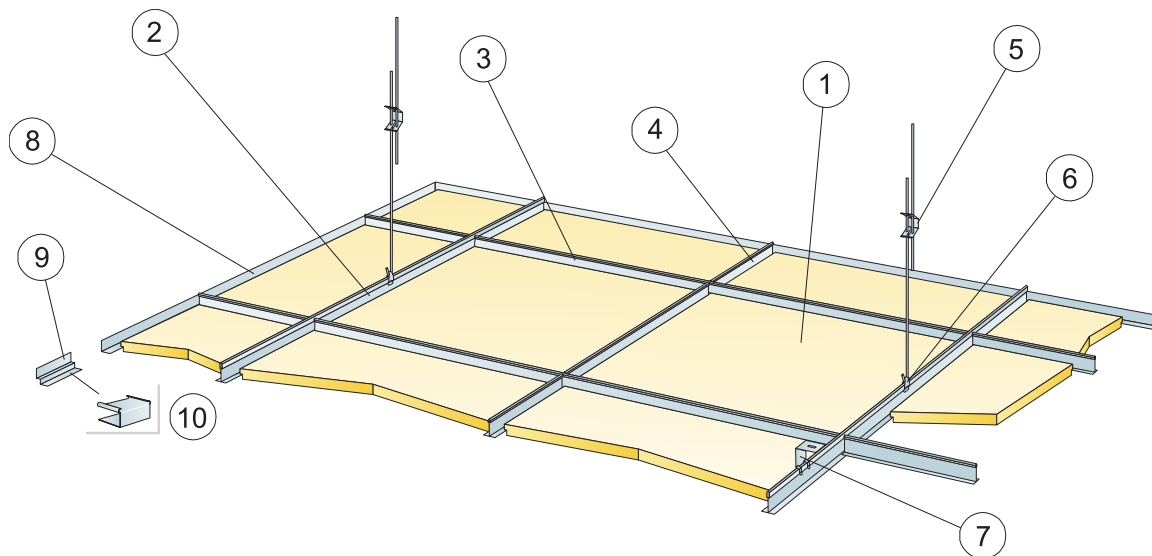

© Ecophon Group

### QUANTITY SPECIFICATION (EXCL. WASTAGE)

	Size, mm		
	600x600	1200x600	1200x1200
1 Gedina E	2,8/m <sup>2</sup>	1,4/m <sup>2</sup>	0,7/m <sup>2</sup>
2 Connect T24 Main runner, installed at 1200 mm centres (max. distance from wall 600 mm, can be extended up to 1200 mm if no live load 0,9m/m <sup>2</sup> between Main runner and wall).	0,9m/m <sup>2</sup>	0,9m/m <sup>2</sup>	0,9m/m <sup>2</sup>
3 Connect T24 Cross Tee, L=1200 mm, installed at 600 mm centres	1,7m/m <sup>2</sup>	1,7m/m <sup>2</sup>	0,7m/m <sup>2</sup>
4 Connect T24 Cross tee, L=600 mm	0,9m/m <sup>2</sup>	-	-
5 Connect Adjustable hanger, installed at 1200 mm centres (max. distance from wall 600 mm)	0,7/m <sup>2</sup>	0,7/m <sup>2</sup>	0,7/m <sup>2</sup>
6 Connect Hanger Clip (not to be used in swimming hall environments)	0,7/m <sup>2</sup>	0,7/m <sup>2</sup>	0,7/m <sup>2</sup>
7 For direct installation: Connect Direct Bracket, installed at 1200 mm centres	0,7/m <sup>2</sup>	0,7/m <sup>2</sup>	0,7/m <sup>2</sup>
8 Connect Angle Trim, fixed at 300 mm centres	as required	as required	as required
9 Connect Shadow-line Trim, fixed at 300 mm centres	as required	as required	as required
10 Connect E-plug (for Connect Shadow-line Trim)	as required	as required	as required
Δ Min. overall depth of system, with adjustable hanger: 110 mm, with direct bracket: 60 mm	-	-	-
δ Min. demounting depth: 120 mm (130 mm with 1200x1200)	-	-	-
For luminaire integration in panels use Connect Bridging	-	-	-

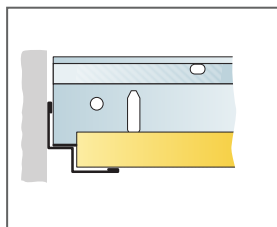
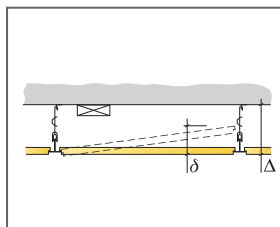

Straight cut, panel resting on shadow-line trim.

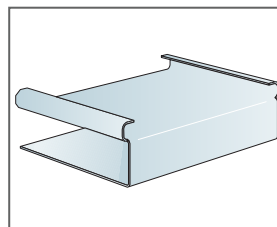

Connect E-plug

Size, mm	Max live load [N]	Min load bearing capacity [N]
600x600x15	30	160
1200x600x15	30	160
1200x1200x15	30	160

Live load/load bearing capacity

## INSTALLATION DIAGRAM (M270) FOR ECOPHON GEDINA E, CONNECT T24 MAIN RUNNER INSTALLED AT 1800 MM CENTRES

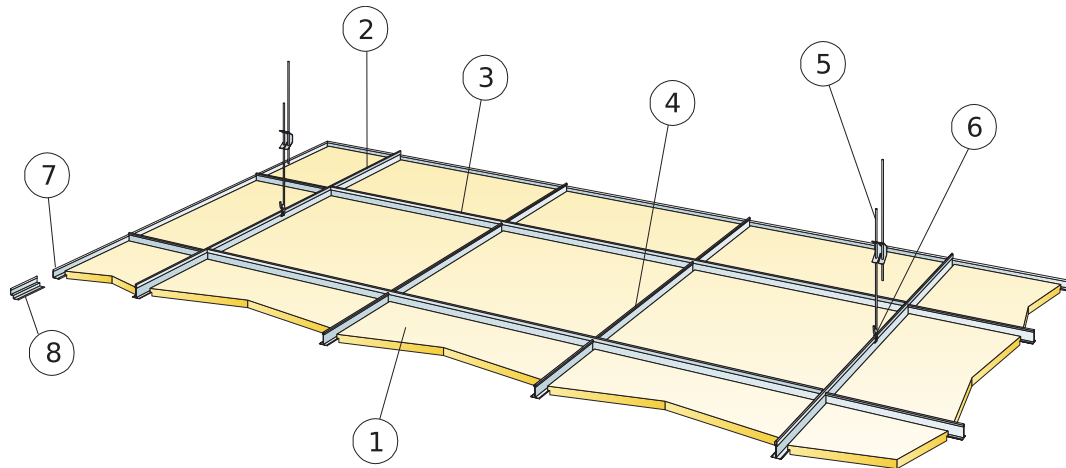

© Ecophon Group

### QUANTITY SPECIFICATION (EXCL. WASTAGE)

	Size, mm
	<b>600x600</b>
1 Gedina E	2,8/m <sup>2</sup>
2 Connect T24 Main runner, installed at 1800 mm centres (max. distance from wall 600 mm, can be extended up to 1200 mm if no live load between Main runner and wall).	0,56/m <sup>2</sup>
3 Connect T24 Cross tee, L=1800 mm	1,7m/m <sup>2</sup>
4 Connect T24 Cross tee, L=600 mm	1,1m/m <sup>2</sup>
5 Connect Adjustable hanger, installed at 1200 mm centres (max. distance from wall 600 mm)	0,46/m <sup>2</sup>
6 Connect Hanger clip	0,46/m <sup>2</sup>
7 Connect Angle trim, fixed at 300 mm centres	as required
8 Alt. Connect Shadow-line Trim, fixed c300	as required
Δ Min. overall depth of system, with adjustable hanger: 110 mm, with direct bracket: 60 mm	-
δ Min. demounting depth: 120 mm	-
For luminaire integration in panels use Connect Bridging	-

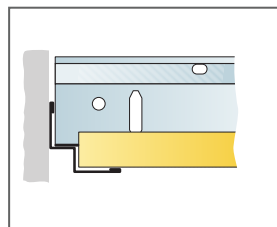
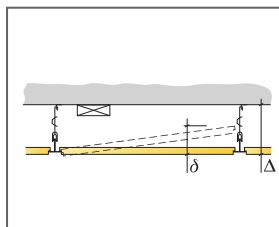

Straight cut, panel resting on shadow-line trim.

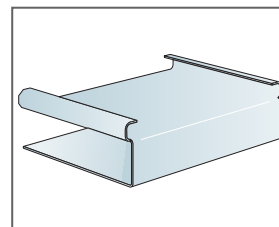

Connect E-plug

Size, mm	Max live load [N]	Min load bearing capacity [N]
600x600x15	20	160

Live load/load bearing capacity

## INSTALLATION DIAGRAM (M401) FOR ECOPHON GEDINA E T15

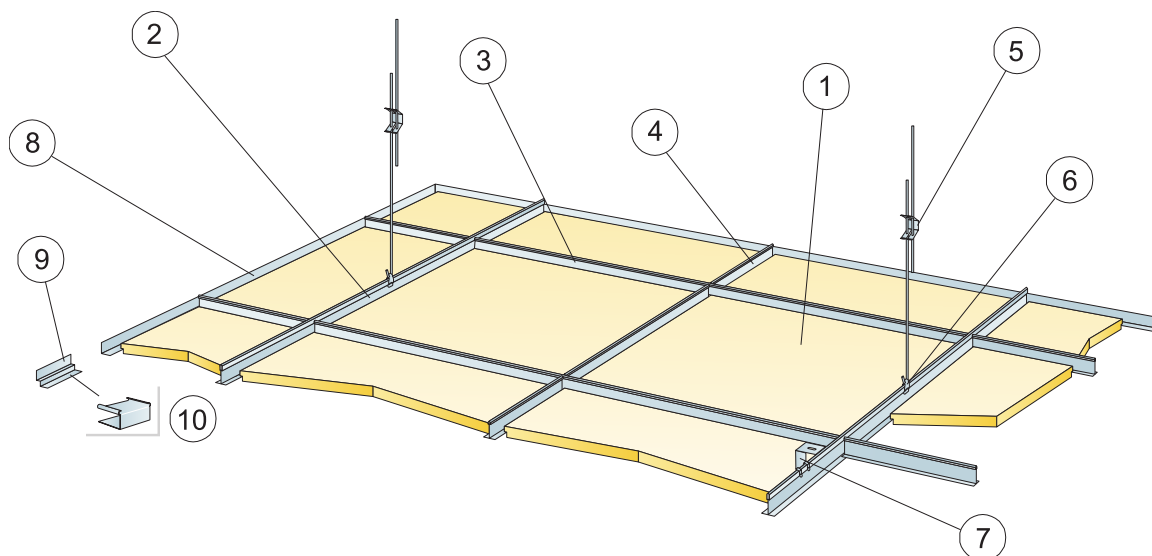

© Ecophon Group

### QUANTITY SPECIFICATION (EXCL. WASTAGE)

	Size, mm	
	600x600	1200x600
1 Gedina E T15	2,8/m <sup>2</sup>	1,4/m <sup>2</sup>
2 Connect T15 Main runner, installed at 1200 mm centres (max. distance from wall 600 mm, can be extended up to 1200 mm if no live load between Main runner and wall).	0,9m/m <sup>2</sup>	0,9m/m <sup>2</sup>
3 Connect T15 Cross tee, L=1200 mm, installed at 600 mm centres	1,7m/m <sup>2</sup>	1,7m/m <sup>2</sup>
4 Connect T15 Cross tee, L=600 mm	0,9m/m <sup>2</sup>	-
5 Connect Adjustable hanger, installed at 1200 mm centres (max. distance from wall 600 mm)	0,7/m <sup>2</sup>	0,7/m <sup>2</sup>
6 Connect Hanger Clip (not to be used in swimming hall environments)	0,7/m <sup>2</sup>	0,7/m <sup>2</sup>
7 For direct installation: Connect Direct Bracket, installed at 1200 mm centres	0,7/m <sup>2</sup>	0,7/m <sup>2</sup>
8 Connect Angle Trim, fixed at 300 mm centres	as required	as required
9 Connect Shadow-line Trim, fixed at 300 mm centres	as required	as required
Δ Min. overall depth of system, with adjustable hanger: 110 mm, with direct bracket: 60 mm	-	-
δ Min. demounting depth: 120 mm	-	-
For luminaire integration in panels use Connect Bridging	-	-

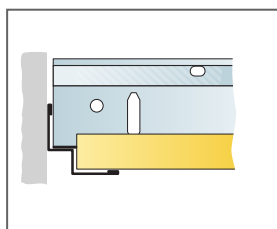
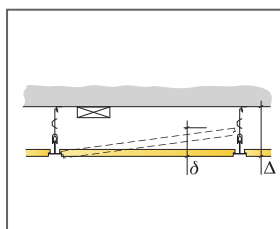

Straight cut, panel resting on shadow-line trim.

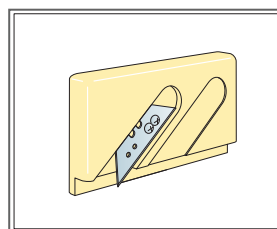

Cutting tool E

Size, mm	Max live load [N]	Min load bearing capacity [N]
600x600x15	30	160
1200x600x15	30	160

Live load/load bearing capacity

# Ecophon Gedina™ A + Extra Bass

The Gedina™ A ceiling has an exposed grid with each tile easily demountable. Placed on top of the Gedina panel is the Extra Bass low frequency absorber. The suspended ceiling system is specially developed for spaces where low frequency absorption is required.



MFC Oostburg, Oostburg, Netherlands

## SYSTEM RANGE

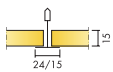

Size, mm	600x600	1200x600
Extra Bass	•	•
T15	•	•
T24	•	•
Thickness (THK)	15	15
Inst. Diagr.	M376, M379	M376

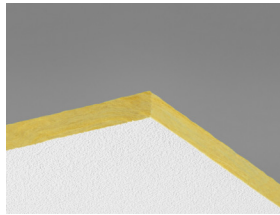

Gedina A tile



Gedina A system

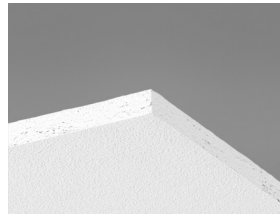

Gedina A tile

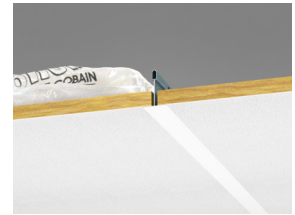

Section of Gedina A + Extra Bass system

## Acoustic



### Sound Absorption:

Test results according to EN ISO 354. Classification according to EN ISO 11654.

$\alpha_p$ , Practical sound absorption coefficient

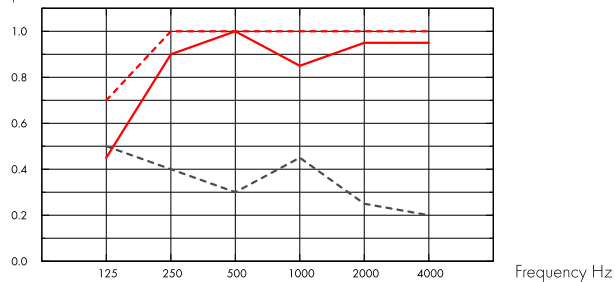

- Gedina A 15 mm, 200 mm o.d.s.
  - - Gedina A 15 mm + Extra Bass 50 mm, 200 mm o.d.s.
  - - - Gedina A/gamma 15 mm, 200 mm o.d.s.
- o.d.s = overall depth of system

	THK mm	o.d.s. mm	$\alpha_p$ , Practical sound absorption coefficient						$\alpha_w$	Sound absorption class
			125 Hz	250 Hz	500 Hz	1000 Hz	2000 Hz	4000 Hz		
-	15	200	0.45	0.90	1.00	0.85	0.95	0.95	0.95	A
+ Extra Bass	65	200	0.70	1.00	1.00	1.00	1.00	1.00	1.00	A
gamma	15	200	0.50	0.40	0.30	0.45	0.25	0.20	0.30	D

## Carbon footprint



	kg CO <sub>2</sub> equiv/m <sup>2</sup>	Life-cycle stages A1 to C4 from EPD, in conformity with ISO 14025 / EN 15804
Gedina A	2,06 (Gedina family EPD in conformity with ISO 14025 / EN 15804)	
Extra Bass	1,62 (Extra Bass EPD in conformity with ISO 14025 / EN 15804)	

## Circularity



Minimum post-consumer recycled content - Gedina A	46%
Minimum post-consumer recycled content - Extra Bass	66%
Recyclability	Fully recyclable

## Fire safety



Country	Fire standard	Class	The glass wool core of the tiles is tested and classified as non-combustible according to EN ISO 1182.
Europe	EN 13501-1	A2-s1,d0	



### Humidity Resistance

---

Class C, relative humidity 95% and 30°C, according to EN 13964:2014



### Visual appearance

---

White 500, nearest NCS colour sample S 0500-N, 84% light reflectance.



### Cleanability

---

Daily dusting and vacuum cleaning. Weekly wet wiping.



### Accessibility

---

The tiles are easily demountable. Minimum demounting depth according to installation diagrams.



### Installation

---

Installed according to installation diagrams, installation guides and drawing aid. For information regarding minimum overall depth of system see quantity specification.



### System weight

---

	kg/m <sup>2</sup>	Weight information is indicative and subject to variation.
Gedina E	1,3	
Gedina E + Connect grid system	2,3	
Gedina E/Gamma	1,7	
Gedina E/Gamma + Connect grid system	2,7	



### Mechanical properties

---

See table about Max live load and Min load bearing capacity and Functional demands, Mechanical properties at [www.ecophon.com](http://www.ecophon.com).



### CE

---

Ecophon ceiling systems are CE marked according to the European harmonized standard EN 13964:2014. CE marked construction products are covered by a Declaration of Performance (DOP) which enables customers and users to easily compare performance of products available on the European market.



## INSTALLATION DIAGRAM (M376) FOR ECOPHON GEDINA A + EXTRA BASS

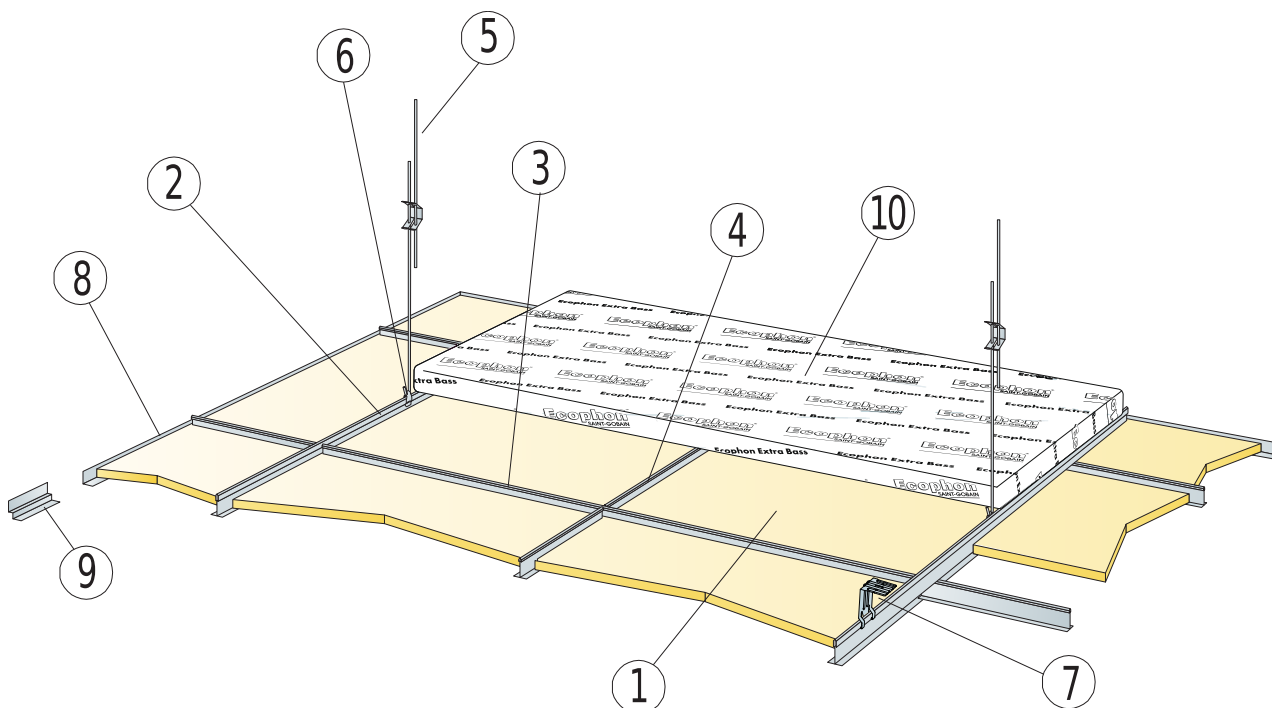

### QUANTITY SPECIFICATION (EXCL. WASTAGE)

	Size, mm	
	600x600	1200x600
1 Gedina A	2,8/m <sup>2</sup>	1,4/m <sup>2</sup>
2 Connect T24 or T15 Main runner, installed at 1200 mm centres (max. distance from wall 600 mm, can be extended up to 1200 mm if no live load between Main runner and wall).	0,9m/m <sup>2</sup>	0,9m/m <sup>2</sup>
3 Connect T24 or T15 Cross tee, L=1200 mm, installed at 600 mm centres	1,7m/m <sup>2</sup>	1,7m/m <sup>2</sup>
4 Connect T24 or T15 Cross tee, L=600 mm	0,9m/m <sup>2</sup>	-
5 Connect Adjustable hanger, installed at 1200 mm centres (max. distance from wall 600 mm)	0,7/m <sup>2</sup>	0,7/m <sup>2</sup>
6 Connect Hanger Clip (not to be used in swimming hall environments)	0,7/m <sup>2</sup>	0,7/m <sup>2</sup>
7 For direct installation: Connect Direct Bracket, installed at 1200 mm centres	0,7/m <sup>2</sup>	0,7/m <sup>2</sup>
8 Connect Angle Trim, fixed at 300 mm centres	as required	as required
9 Connect Shadow-line Trim, fixed at 300 mm centres	as required	as required
10 Extra Bass (1200x600x50 mm)	0,7/m <sup>2</sup>	0,7/m <sup>2</sup>
11	-	-
Δ Min. overall depth of system: 100 mm	-	-
δ Min. demounting depth: 120 mm (tiles without Extra Bass above)	-	-

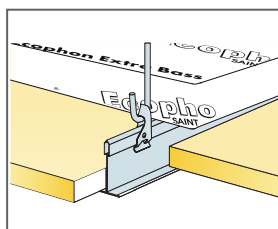
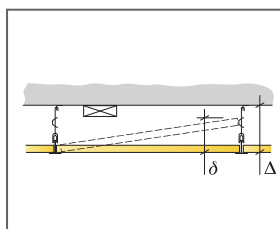

Suspension with adjustable hanger and clip

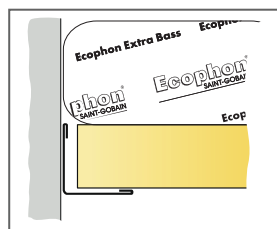

Panels resting on Angle trim

Size, mm	Max live load [N]	Min load bearing capacity [N]
600x600x15	30	160
1200x600x15	30	160

Live load/load bearing capacity

## INSTALLATION DIAGRAM (M379) FOR ECOPHON GEDINA A+EXTRA BASS, CONNECT T24 MAIN RUNNER INSTALLED AT 1800 MM CENTRES

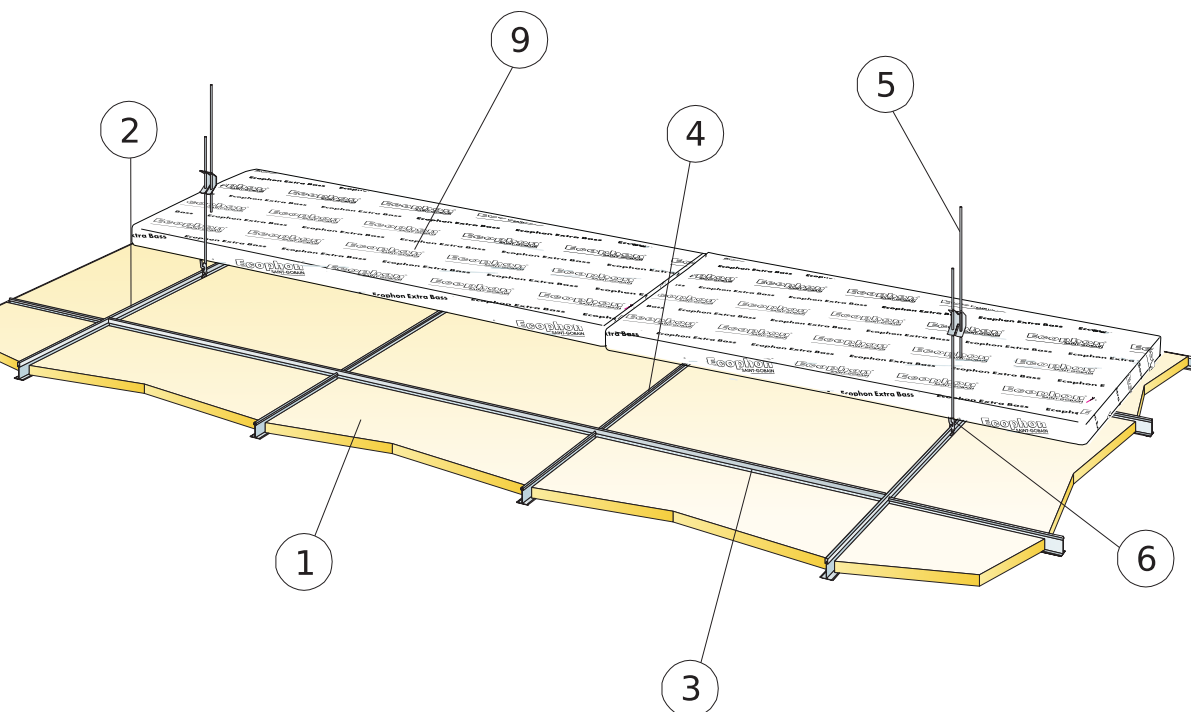

### QUANTITY SPECIFICATION (EXCL. WASTAGE)

	Size, mm
	<b>600x600</b>
1 Gedina A	2,8/m <sup>2</sup>
2 Connect T24 Main runner, installed at 1800 mm centres (max. distance from wall 600 mm, can be extended up to 1200 mm if no live load between Main runner and wall).	0,56m/m <sup>2</sup>
3 Connect T24 Cross tee, L=1800 mm	1,7m/m <sup>2</sup>
4 Connect T24 Cross tee, L=600 mm	1,1m/m <sup>2</sup>
5 Connect Adjustable hanger, installed at 1200 mm centres (max. distance from wall 600 mm)	0,46/m <sup>2</sup>
6 Connect Hanger clip	0,46/m <sup>2</sup>
7 Connect Angle trim, fixed at 300 mm centres	as required
8 Alt. Connect Shadow-line Trim, fixed c300	as required
9 Extra Bass (1200x600x50 mm)	0,7/m <sup>2</sup>
10	-
Δ Min. overall depth of system: 100 mm	-
δ Min. demounting depth: 120 mm (tiles without Extra Bass above)	-

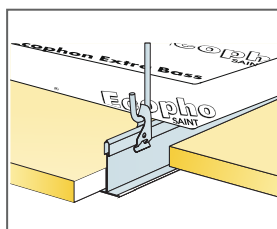
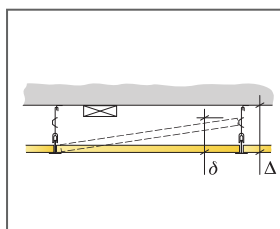

Suspension with adjustable hanger and clip

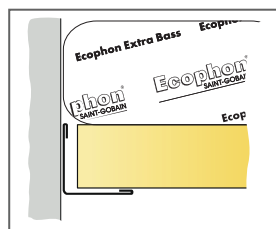

Panels resting on Angle trim

Size, mm	Max live load [N]	Min load bearing capacity [N]
600x600x15	20	160

Live load/load bearing capacity



# Ecophon Gedina™ E + Extra Bass

The Gedina™ E ceiling has a recessed visible grid and a regular edge design. Placed on top of the Gedina E panel is the Extra Bass low frequency absorber. This suspended ceiling system is especially well suited for spaces where low frequency absorption is required.

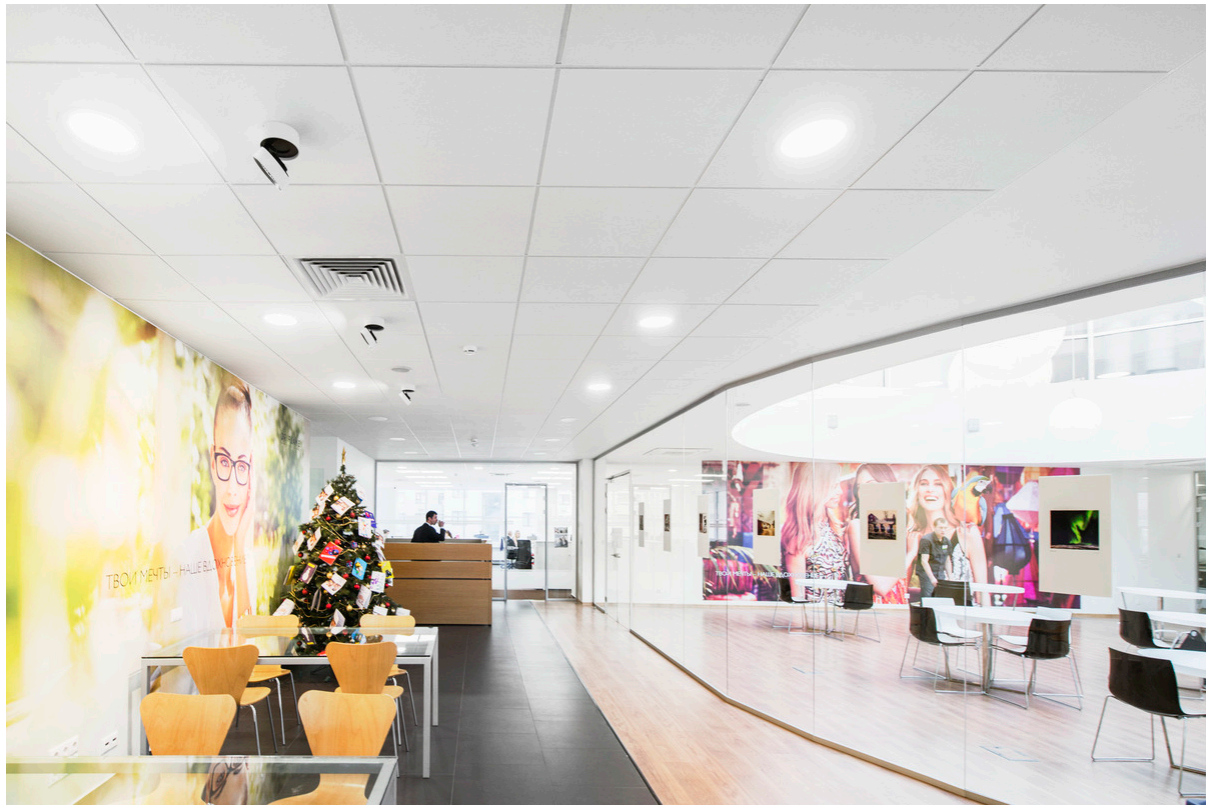

Oriflame, Moscow, Russia

## SYSTEM RANGE

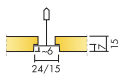

Size, mm	600x600	1200x600
Extra Bass	•	•
T15	•	•
T24	•	•
Thickness (THK)	15	15
Inst. Diagr.	M377, M380	M377



Gedina E tile



Section of Gedina E + Extra Bass system



Gedina E system

## Acoustic



### Sound Absorption:

Test results according to EN ISO 354. Classification according to EN ISO 11654.

$\alpha_p$ , Practical sound absorption coefficient

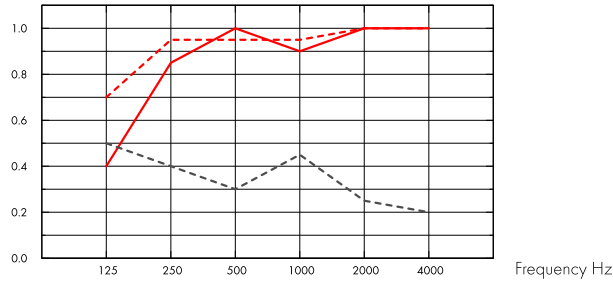

- Gedina E 15 mm, 200 mm o.d.s.
  - - Gedina E 15 mm + Extra Bass 50 mm, 200 mm o.d.s.
  - - - Gedina E/gamma 15 mm, 200 mm o.d.s.
- o.d.s = overall depth of system

	THK mm	o.d.s. mm	$\alpha_p$ , Practical sound absorption coefficient						$\alpha_w$	Sound absorption class
			125 Hz	250 Hz	500 Hz	1000 Hz	2000 Hz	4000 Hz		
-	15	200	0.40	0.85	1.00	0.90	1.00	1.00	1.00	A
+ Extra Bass	65	200	0.70	0.95	0.95	0.95	1.00	1.00	1.00	A
gamma	15	200	0.50	0.40	0.30	0.45	0.25	0.20	0.30	D

## Carbon footprint



	kg CO <sub>2</sub> equiv/m <sup>2</sup>	Life-cycle stages A1 to C4 from EPD, in conformity with ISO 14025 / EN 15804
Gedina E	2,62 (Gedina family EPD in conformity with ISO 14025 / EN 15804)	
Extra Bass	1,62 (Extra Bass EPD in conformity with ISO 14025 / EN 15804)	

## Circularity



Minimum post-consumer recycled content - Gedina A	44%
Minimum post-consumer recycled content - Extra Bass	66%
Recyclability	Fully recyclable

## Fire safety



Country	Fire standard	Class	The glass wool core of the tiles is tested and classified as non-combustible according to EN ISO 1182.
Europe	EN 13501-1	A2-s1,d0	



## Humidity Resistance

Class C, relative humidity 95% and 30°C, according to EN 13964:2014



## Visual appearance

White 500, nearest NCS colour sample S 0500-N, 84% light reflectance.



## Cleanability

Daily dusting and vacuum cleaning. Weekly wet wiping.



## Accessibility

The tiles are easily demountable. Minimum demounting depth according to installation diagrams.



## Installation

Installed according to installation diagrams, installation guides and drawing aid. For information regarding minimum overall depth of system see quantity specification.



## System weight

	kg/m <sup>2</sup>
Gedina E	1,3
Gedina E + Connect grid system	2,3
Gedina E/Gamma	1,7
Gedina E/Gamma + Connect grid system	2,7

Weight information is indicative and subject to variation.



## Mechanical properties

See table about Max live load and Min load bearing capacity and Functional demands, Mechanical properties at [www.ecophon.com](http://www.ecophon.com).



## CE

Ecophon ceiling systems are CE marked according to the European harmonized standard EN 13964:2014. CE marked construction products are covered by a Declaration of Performance (DOP) which enables customers and users to easily compare performance of products available on the European market.

## INSTALLATION DIAGRAM (M377) FOR ECOPHON GEDINA E + EXTRA BASS

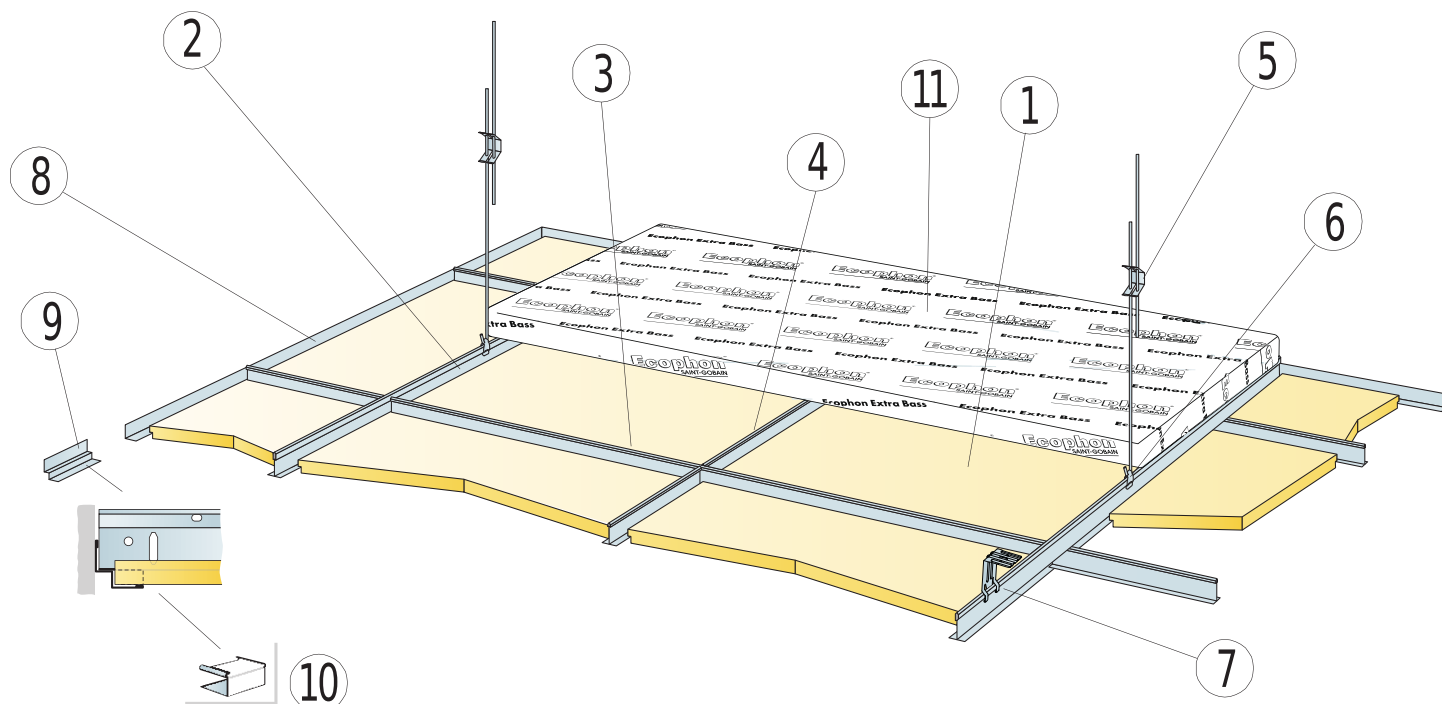

### QUANTITY SPECIFICATION (EXCL. WASTAGE)

	Size, mm	
	600x600	1200x600
1 Gedina E	2,8/m <sup>2</sup>	1,4/m <sup>2</sup>
2 Connect T24 or T15 Main runner, installed at 1200 mm centres (max. distance from wall 600 mm, can be extended up to 1200 mm if no live load between Main runner and wall).	0,9m/m <sup>2</sup>	0,9m/m <sup>2</sup>
3 Connect T24 or T15 Cross tee, L=1200 mm, installed at 600 mm centres	1,7m/m <sup>2</sup>	1,7m/m <sup>2</sup>
4 Connect T24 or T15 Cross tee, L=600 mm	0,9m/m <sup>2</sup>	-
5 Connect Adjustable hanger, installed at 1200 mm centres (max. distance from wall 600 mm)	0,7/m <sup>2</sup>	0,7/m <sup>2</sup>
6 Connect Hanger Clip (not to be used in swimming hall environments)	0,7/m <sup>2</sup>	0,7/m <sup>2</sup>
7 For direct installation: Connect Direct Bracket, installed at 1200 mm centres	0,7/m <sup>2</sup>	0,7/m <sup>2</sup>
8 Connect Angle Trim, fixed at 300 mm centres	as required	as required
9 Connect Shadow-line Trim, fixed at 300 mm centres	as required	as required
10 Connect E-plug (for Connect Shadow-line Trim)	as required	as required
11 Extra Bass (1200x600x50 mm)	0,7/m <sup>2</sup>	0,7/m <sup>2</sup>
12	-	-
Δ Min. overall depth of system: 110 mm	-	-
δ Min. demounting depth T15: 110 mm, T24: 90 mm (tiles without Extra Bass above)	-	-

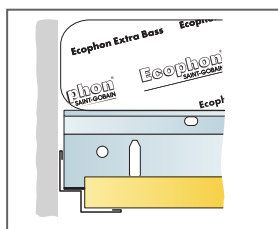
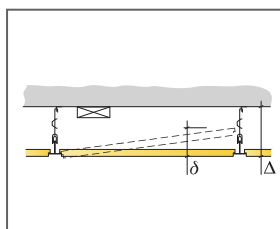

Straight cut, panel resting on shadow-line trim.

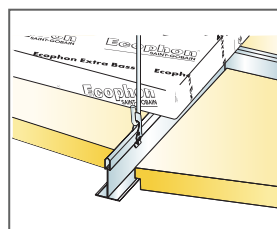

Suspension with adjustable hanger and clip

Size, mm	Max live load [N]	Min load bearing capacity [N]
600x600x15	50	160
1200x600x15	50	160

Live load/load bearing capacity

## INSTALLATION DIAGRAM (M380) FOR ECOPHON GEDINA E + EXTRA BASS, CONNECT T24 MAIN RUNNER INSTALLED AT 1800 MM CENTRES

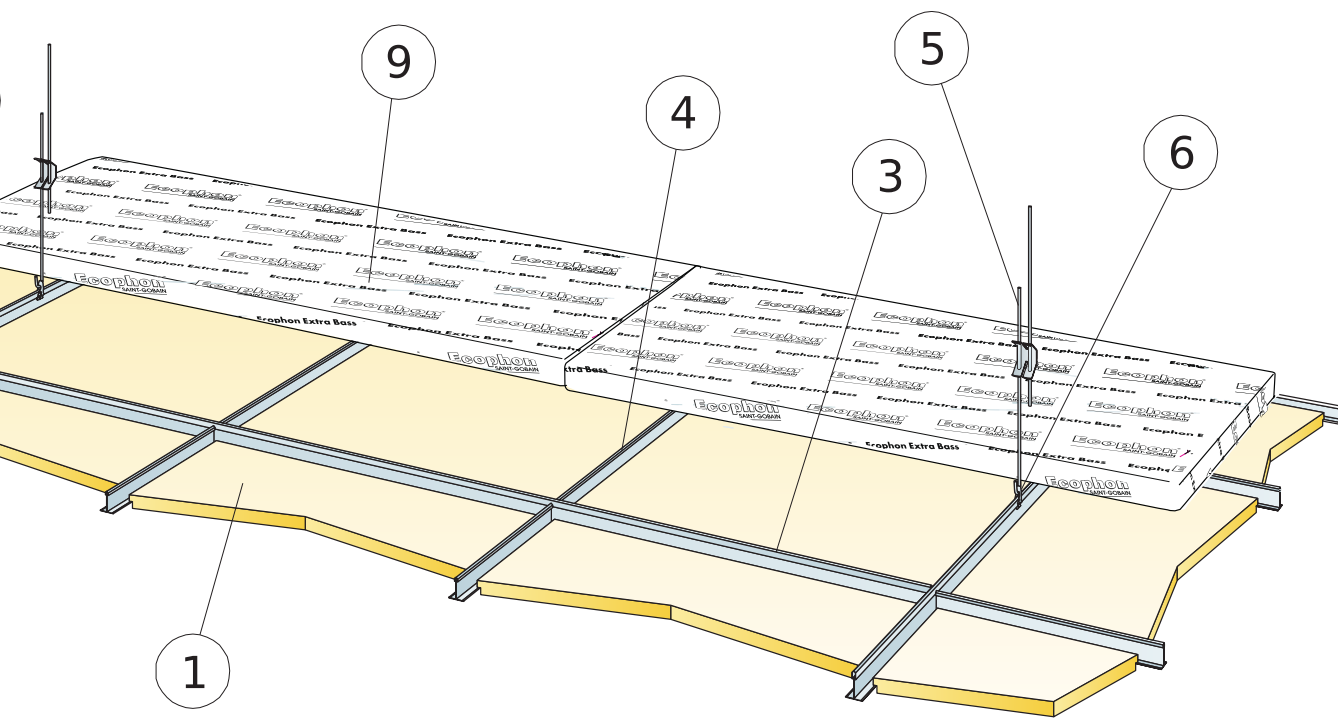

### QUANTITY SPECIFICATION (EXCL. WASTAGE)

	Size, mm
	<b>600x600</b>
1 Gedina E	2,8/m <sup>2</sup>
2 Connect T24 Main runner, installed at 1800 mm centres (max. distance from wall 600 mm, can be extended up to 1200 mm if no live load between Main runner and wall).	0,56/m <sup>2</sup>
3 Connect T24 Cross tee, L=1800 mm	1,7m/m <sup>2</sup>
4 Connect T24 Cross tee, L=600 mm	1,1m/m <sup>2</sup>
5 Connect Adjustable hanger, installed at 1200 mm centres (max. distance from wall 600 mm)	0,46/m <sup>2</sup>
6 Connect Hanger clip	0,46/m <sup>2</sup>
7 Connect Angle trim, fixed at 300 mm centres	as required
8 Alt. Connect Shadow-line Trim, fixed c300	as required
9 Extra Bass (1200x600x50 mm)	0,7/m <sup>2</sup>
10	-
Δ Min. overall depth of system: 110 mm	-
δ Min. demounting depth: 120 mm (tiles without Extra Bass above)	-

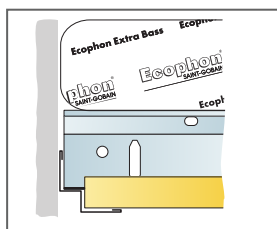
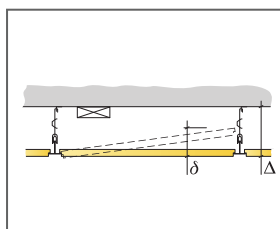

Straight cut, panel resting on shadow-line trim.

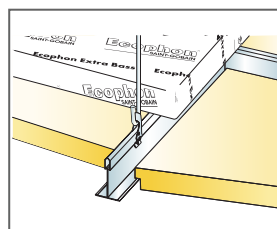

Suspension with adjustable hanger and clip

Size, mm	Max live load [N]	Min load bearing capacity [N]
600x600x15	20	160

Live load/load bearing capacity

# Ecophon Gedina™ A + Extra Bass

The Gedina™ A ceiling has an exposed grid with each tile easily demountable. Placed on top of the Gedina panel is the Extra Bass low frequency absorber. The suspended ceiling system is specially developed for spaces where low frequency absorption is required.



MFC Oostburg, Oostburg, Netherlands

## SYSTEM RANGE

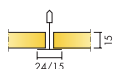

Size, mm	600x600	1200x600
Extra Bass	•	•
T15	•	•
T24	•	•
Thickness (THK)	15	15
Inst. Diagr.	M376, M379	M376



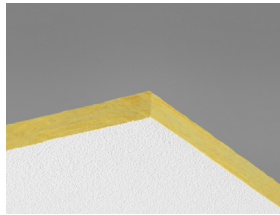

Gedina A tile



Gedina A system

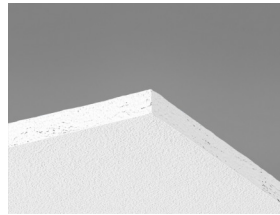

Gedina A tile

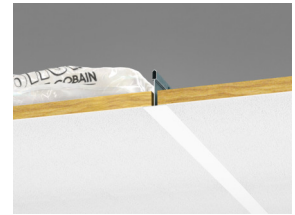

Section of Gedina A + Extra Bass system

## Acoustic



### Sound Absorption:

Test results according to EN ISO 354. Classification according to EN ISO 11654.

$\alpha_p$ , Practical sound absorption coefficient

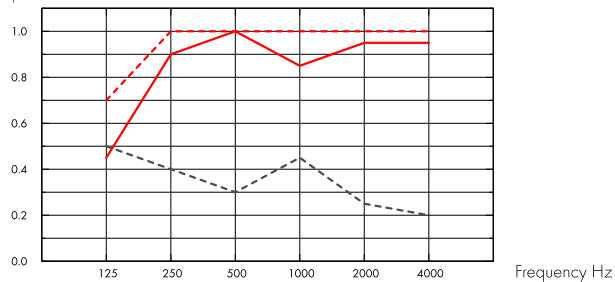

- Gedina A 15 mm, 200 mm o.d.s.
  - - Gedina A 15 mm + Extra Bass 50 mm, 200 mm o.d.s.
  - - - Gedina A/gamma 15 mm, 200 mm o.d.s.
- o.d.s = overall depth of system

	THK mm	o.d.s. mm	$\alpha_p$ , Practical sound absorption coefficient						$\alpha_{wv}$	Sound absorption class
			125 Hz	250 Hz	500 Hz	1000 Hz	2000 Hz	4000 Hz		
-	15	200	0.45	0.90	1.00	0.85	0.95	0.95	0.95	A
+ Extra Bass	65	200	0.70	1.00	1.00	1.00	1.00	1.00	1.00	A
gamma	15	200	0.50	0.40	0.30	0.45	0.25	0.20	0.30	D

## Indoor Air Quality



Certificate / Label	600x600, 1200x600 (NE)	Other formats
Eurofins Indoor Air Comfort®	IAC Gold	IAC
French VOC	A+	A
Finnish M1		•



## Carbon footprint



	kg CO <sub>2</sub> equiv/m <sup>2</sup>
Gedina A	2,06 (Gedina family EPD in conformity with ISO 14025 / EN 15804)
Extra Bass	1,62 (Extra Bass EPD in conformity with ISO 14025 / EN 15804)

Life-cycle stages A1 to C4 from EPD, in conformity with ISO 14025 / EN 15804



## Circularity

Minimum post-consumer recycled content - Gedina A	46%
Minimum post-consumer recycled content - Extra Bass	66%
Recyclability	Fully recyclable



## Fire safety

Country	Fire standard	Class
Europe	EN 13501-1	A2-s1,d0

The glass wool core of the tiles is tested and classified as non-combustible according to EN ISO 1182.



## Humidity Resistance

Class C, relative humidity 95% and 30°C, according to EN 13964:2014



## Visual appearance

White 500, nearest NCS colour sample S 0500-N, 84% light reflectance.



## Cleanability

Daily dusting and vacuum cleaning. Weekly wet wiping.



## Accessibility

The tiles are easily demountable. Minimum demounting depth according to installation diagrams.



## Installation

Installed according to installation diagrams, installation guides and drawing aid. For information regarding minimum overall depth of system see quantity specification.



## System weight

The weight of the system (including suspension grid and Extra Bass) should be approximately 3 kg/m<sup>2</sup>.



## Mechanical properties

See table about Max live load and Min load bearing capacity and Functional demands, Mechanical properties at [www.ecophon.com](http://www.ecophon.com).



## CE

Ecophon ceiling systems are CE marked according to the European harmonized standard EN 13964:2014. CE marked construction products are covered by a Declaration of Performance (DOP) which enables customers and users to easily compare performance of products available on the European market.

## INSTALLATION DIAGRAM (M376) FOR ECOPHON GEDINA A + EXTRA BASS

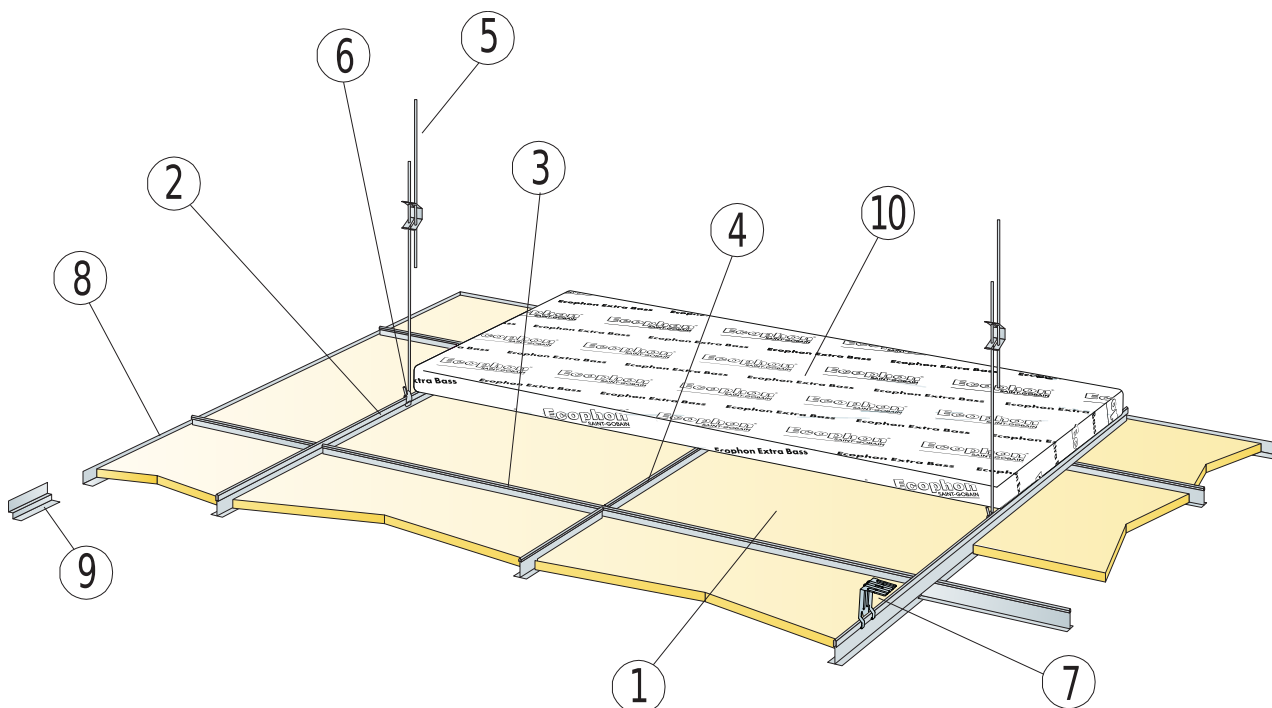

### QUANTITY SPECIFICATION (EXCL. WASTAGE)

	Size, mm	
	600x600	1200x600
1 Gedina A	2,8/m <sup>2</sup>	1,4/m <sup>2</sup>
2 Connect T24 or T15 Main runner, installed at 1200 mm centres (max. distance from wall 600 mm, can be extended up to 1200 mm if no live load between Main runner and wall).	0,9m/m <sup>2</sup>	0,9m/m <sup>2</sup>
3 Connect T24 or T15 Cross tee, L=1200 mm, installed at 600 mm centres	1,7m/m <sup>2</sup>	1,7m/m <sup>2</sup>
4 Connect T24 or T15 Cross tee, L=600 mm	0,9m/m <sup>2</sup>	-
5 Connect Adjustable hanger, installed at 1200 mm centres (max. distance from wall 600 mm)	0,7/m <sup>2</sup>	0,7/m <sup>2</sup>
6 Connect Hanger Clip (not to be used in swimming hall environments)	0,7/m <sup>2</sup>	0,7/m <sup>2</sup>
7 For direct installation: Connect Direct Bracket, installed at 1200 mm centres	0,7/m <sup>2</sup>	0,7/m <sup>2</sup>
8 Connect Angle Trim, fixed at 300 mm centres	as required	as required
9 Connect Shadow-line Trim, fixed at 300 mm centres	as required	as required
10 Extra Bass (1200x600x50 mm)	0,7/m <sup>2</sup>	0,7/m <sup>2</sup>
11	-	-
Δ Min. overall depth of system: 100 mm	-	-
δ Min. demounting depth: 120 mm (tiles without Extra Bass above)	-	-

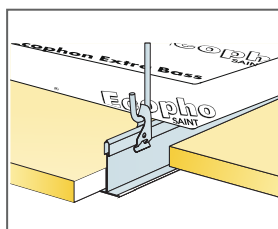
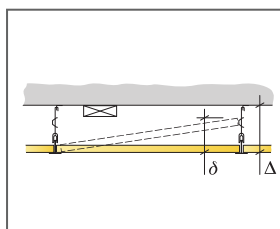

Suspension with adjustable hanger and clip

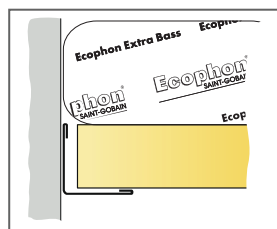

Panels resting on Angle trim

Size, mm	Max live load [N]	Min load bearing capacity [N]
600x600x15	30	160
1200x600x15	30	160

Live load/load bearing capacity

## INSTALLATION DIAGRAM (M379) FOR ECOPHON GEDINA A+EXTRA BASS, CONNECT T24 MAIN RUNNER INSTALLED AT 1800 MM CENTRES

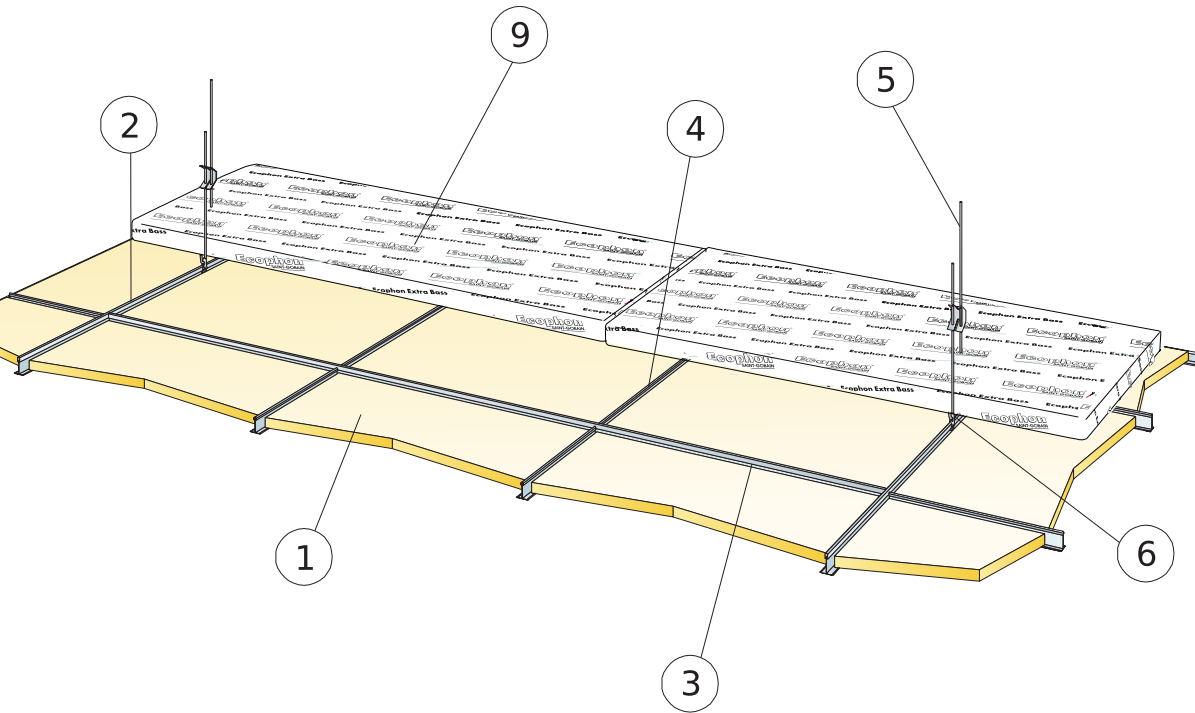

### QUANTITY SPECIFICATION (EXCL. WASTAGE)

	Size, mm
	<b>600x600</b>
1 Gedina A	2,8/m <sup>2</sup>
2 Connect T24 Main runner, installed at 1800 mm centres (max. distance from wall 600 mm, can be extended up to 1200 mm if no live load between Main runner and wall).	0,56m/m <sup>2</sup>
3 Connect T24 Cross tee, L=1800 mm	1,7m/m <sup>2</sup>
4 Connect T24 Cross tee, L=600 mm	1,1m/m <sup>2</sup>
5 Connect Adjustable hanger, installed at 1200 mm centres (max. distance from wall 600 mm)	0,46/m <sup>2</sup>
6 Connect Hanger clip	0,46/m <sup>2</sup>
7 Connect Angle trim, fixed at 300 mm centres	as required
8 Alt. Connect Shadow-line Trim, fixed c300	as required
9 Extra Bass (1200x600x50 mm)	0,7/m <sup>2</sup>
10	-
Δ Min. overall depth of system: 100 mm	-
δ Min. demounting depth: 120 mm (tiles without Extra Bass above)	-

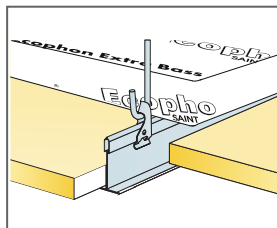
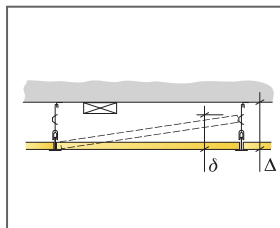

Suspension with adjustable hanger and clip

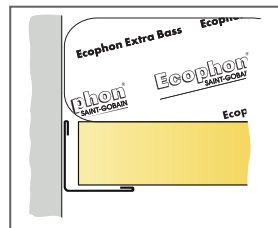

Panels resting on Angle trim

Size, mm	Max live load [N]	Min load bearing capacity [N]
600x600x15	20	160

Live load/load bearing capacity



# Ecophon Gedina™ E + Extra Bass

The Gedina™ E ceiling has a recessed visible grid and a tegular edge design. Placed on top of the Gedina E panel is the Extra Bass low frequency absorber. This suspended ceiling system is especially well suited for spaces where low frequency absorption is required.

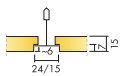

## SYSTEM RANGE

Size, mm	600x600	1200x600
Extra Bass	•	•
T15	•	•
T24	•	•
Thickness (THK)	15	15
Inst. Diagr.	M377, M380	M377



Gedina E tile



Section of Gedina E + Extra Bass system



Gedina E system

## Acoustic



### Sound Absorption:

Test results according to EN ISO 354. Classification according to EN ISO 11654.

$\alpha_p$ , Practical sound absorption coefficient

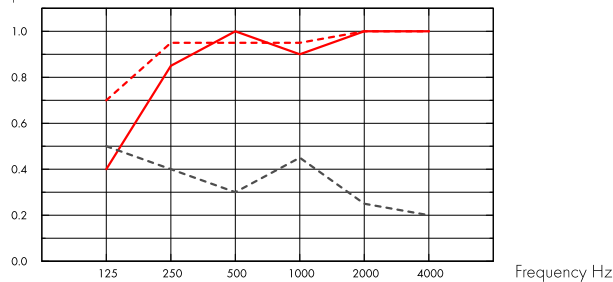

- Gedina E 15 mm, 200 mm o.d.s.
  - - Gedina E 15 mm + Extra Bass 50 mm, 200 mm o.d.s.
  - - - Gedina E/gamma 15 mm, 200 mm o.d.s.
- o.d.s = overall depth of system

	THK mm	o.d.s. mm	$\alpha_p$ , Practical sound absorption coefficient						$\alpha_{wv}$	Sound absorption class
			125 Hz	250 Hz	500 Hz	1000 Hz	2000 Hz	4000 Hz		
-	15	200	0.40	0.85	1.00	0.90	1.00	1.00	1.00	A
+ Extra Bass	65	200	0.70	0.95	0.95	0.95	1.00	1.00	1.00	A
gamma	15	200	0.50	0.40	0.30	0.45	0.25	0.20	0.30	D

## Indoor Air Quality



Certificate / Label	600x600, 1200x600 (NE)	Other formats
Eurofins Indoor Air Comfort®	IAC Gold	IAC
French VOC	A+	A
Finnish M1		•



## Carbon footprint



	kg CO <sub>2</sub> equiv/m <sup>2</sup>
Gedina E	2,62 (Gedina family EPD in conformity with ISO 14025 / EN 15804)
Extra Bass	1,62 (Extra Bass EPD in conformity with ISO 14025 / EN 15804)

Life-cycle stages A1 to C4 from EPD, in conformity with ISO 14025 / EN 15804



## Circularity

Minimum post-consumer recycled content - Gedina A	44%
Minimum post-consumer recycled content - Extra Bass	66%
Recyclability	Fully recyclable



## Fire safety

Country	Fire standard	Class
Europe	EN 13501-1	A2-s1,d0

The glass wool core of the tiles is tested and classified as non-combustible according to EN ISO 1182.



## Humidity Resistance

Class C, relative humidity 95% and 30°C, according to EN 13964:2014



## Visual appearance

White 500, nearest NCS colour sample S 0500-N, 84% light reflectance.



## Cleanability

Daily dusting and vacuum cleaning. Weekly wet wiping.



## Accessibility

The tiles are easily demountable. Minimum demounting depth according to installation diagrams.



## Installation

Installed according to installation diagrams, installation guides and drawing aid. For information regarding minimum overall depth of system see quantity specification.



## System weight

The weight of the system (including suspension grid and Extra Bass) should be approximately 3 kg/m<sup>2</sup>.



## Mechanical properties

See table about Max live load and Min load bearing capacity and Functional demands, Mechanical properties at [www.ecophon.com](http://www.ecophon.com).



## CE

Ecophon ceiling systems are CE marked according to the European harmonized standard EN 13964:2014. CE marked construction products are covered by a Declaration of Performance (DOP) which enables customers and users to easily compare performance of products available on the European market.

## INSTALLATION DIAGRAM (M377) FOR ECOPHON GEDINA E + EXTRA BASS

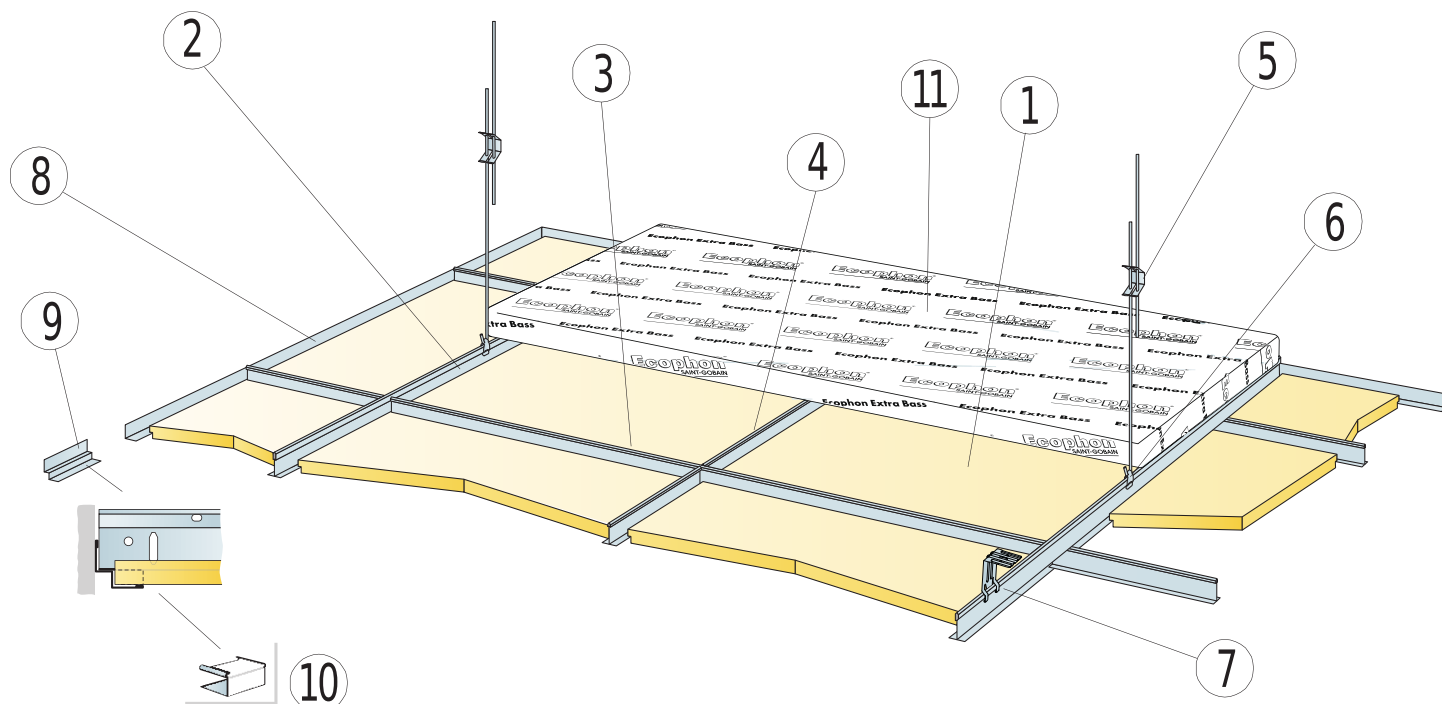

### QUANTITY SPECIFICATION (EXCL. WASTAGE)

	Size, mm	
	600x600	1200x600
1 Gedina E	2,8/m <sup>2</sup>	1,4/m <sup>2</sup>
2 Connect T24 or T15 Main runner, installed at 1200 mm centres (max. distance from wall 600 mm, can be extended up to 1200 mm if no live load between Main runner and wall).	0,9m/m <sup>2</sup>	0,9m/m <sup>2</sup>
3 Connect T24 or T15 Cross tee, L=1200 mm, installed at 600 mm centres	1,7m/m <sup>2</sup>	1,7m/m <sup>2</sup>
4 Connect T24 or T15 Cross tee, L=600 mm	0,9m/m <sup>2</sup>	-
5 Connect Adjustable hanger, installed at 1200 mm centres (max. distance from wall 600 mm)	0,7/m <sup>2</sup>	0,7/m <sup>2</sup>
6 Connect Hanger Clip (not to be used in swimming hall environments)	0,7/m <sup>2</sup>	0,7/m <sup>2</sup>
7 For direct installation: Connect Direct Bracket, installed at 1200 mm centres	0,7/m <sup>2</sup>	0,7/m <sup>2</sup>
8 Connect Angle Trim, fixed at 300 mm centres	as required	as required
9 Connect Shadow-line Trim, fixed at 300 mm centres	as required	as required
10 Connect E-plug (for Connect Shadow-line Trim)	as required	as required
11 Extra Bass (1200x600x50 mm)	0,7/m <sup>2</sup>	0,7/m <sup>2</sup>
12	-	-
Δ Min. overall depth of system: 110 mm	-	-
δ Min. demounting depth T15: 110 mm, T24: 90 mm (tiles without Extra Bass above)	-	-

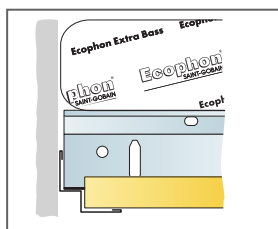
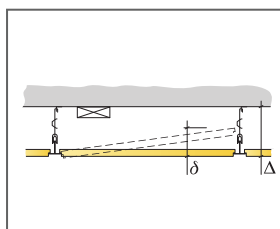

Straight cut, panel resting on shadow-line trim.

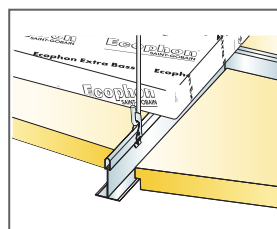

Suspension with adjustable hanger and clip

Size, mm	Max live load [N]	Min load bearing capacity [N]
600x600x15	50	160
1200x600x15	50	160

Live load/load bearing capacity



## INSTALLATION DIAGRAM (M380) FOR ECOPHON GEDINA E + EXTRA BASS, CONNECT T24 MAIN RUNNER INSTALLED AT 1800 MM CENTRES

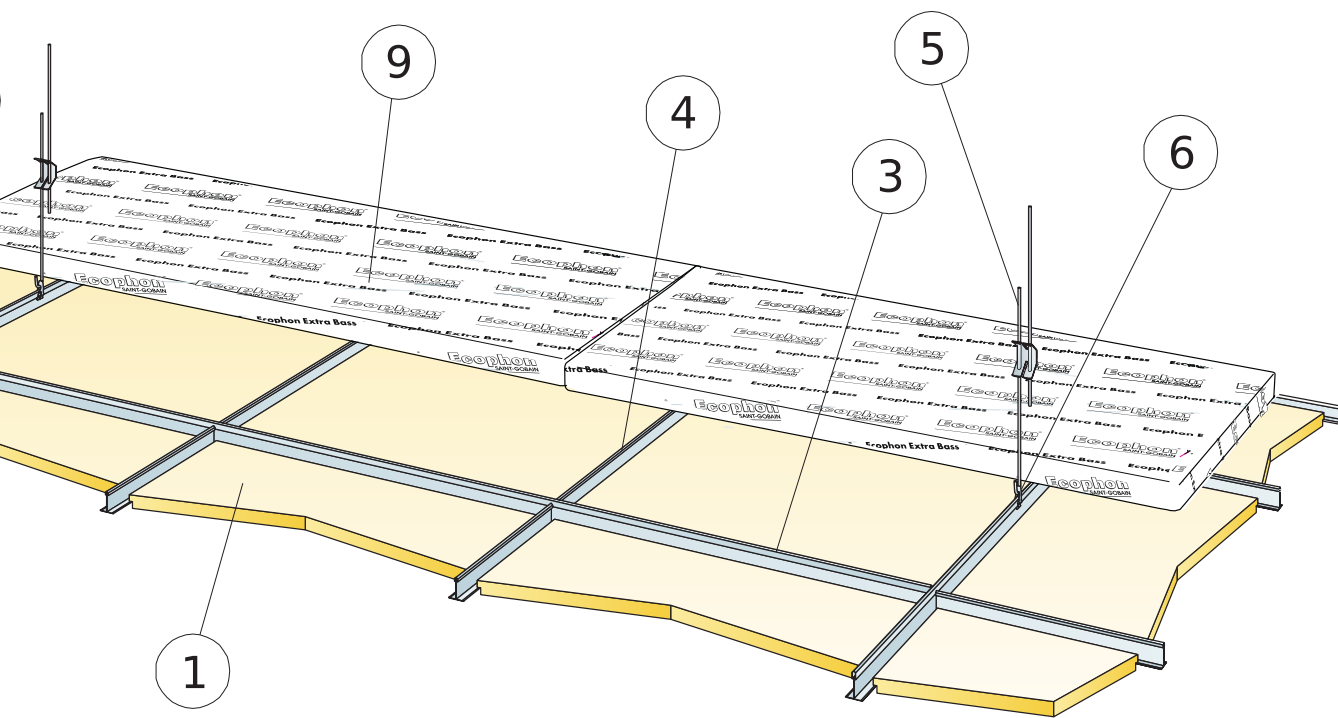

### QUANTITY SPECIFICATION (EXCL. WASTAGE)

	Size, mm
	<b>600x600</b>
1 Gedina E	2,8/m <sup>2</sup>
2 Connect T24 Main runner, installed at 1800 mm centres (max. distance from wall 600 mm, can be extended up to 1200 mm if no live load between Main runner and wall).	0,56/m <sup>2</sup>
3 Connect T24 Cross tee, L=1800 mm	1,7m/m <sup>2</sup>
4 Connect T24 Cross tee, L=600 mm	1,1m/m <sup>2</sup>
5 Connect Adjustable hanger, installed at 1200 mm centres (max. distance from wall 600 mm)	0,46/m <sup>2</sup>
6 Connect Hanger clip	0,46/m <sup>2</sup>
7 Connect Angle trim, fixed at 300 mm centres	as required
8 Alt. Connect Shadow-line Trim, fixed c300	as required
9 Extra Bass (1200x600x50 mm)	0,7/m <sup>2</sup>
10	-
Δ Min. overall depth of system: 110 mm	-
δ Min. demounting depth: 120 mm (tiles without Extra Bass above)	-

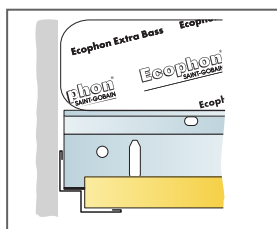
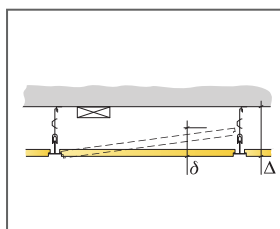

Straight cut, panel resting on shadow-line trim.

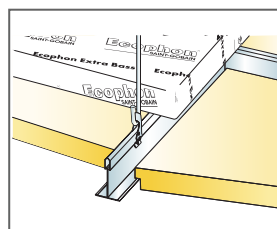

Suspension with adjustable hanger and clip

Size, mm	Max live load [N]	Min load bearing capacity [N]
600x600x15	20	160

Live load/load bearing capacity